

PAPERGEO

User Guide

GeoDict release 2023

Published: February 19, 2023

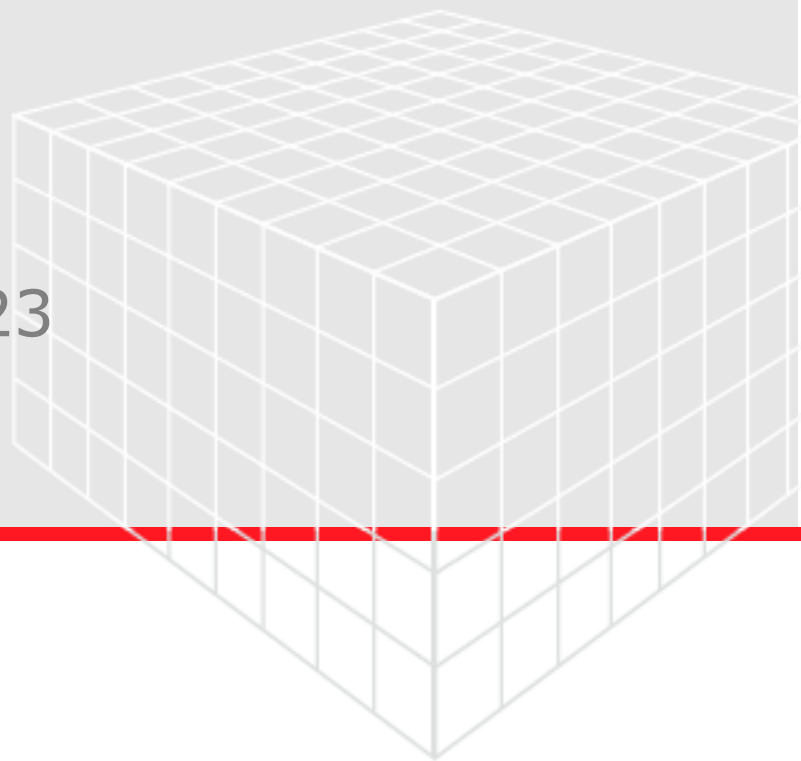

GEO DICT

<https://doi.org/10.30423/userguide.geodict>

© Math2Market GmbH 2023

Citation:

Janine Hilden, Sebastian Rief, Barbara Planas. GeoDict 2023 User Guide. PaperGeo handbook. Math2Market GmbH, Germany, doi.org/10.30423/userguide.geodict

All rights reserved. It is not permitted to reproduce the book or parts thereof in any form by photocopy, microfilm or other methods or to transfer it into a language suitable for machines, in particular data processing systems, without the express permission of the publisher. The same applies to the right of public reproduction.

The handbooks in the User Guide series of Math2Market GmbH can be obtained from:

Math2Market GmbH
Richard-Wagner-Strasse 1
67655 Kaiserslautern
Germany

Phone: +49 631 205 605 0
Fax: +49 631 205 605 99
Email: info@math2market.de
Web: www.math2market.de

GENERATING PAPER STRUCTURES WITH PAPERGEO	1
PAPERGEO SECTION	2
CREATE CELLULOSE FIBERS	4
Create Options	5
CREATE IN CURRENT DOMAIN AND KEEP CURRENT OBJECTS / STRUCTURE	5
DOMAIN	7
NX, NY, NZ, AND VOXEL LENGTH	7
ORIGIN X, ORIGIN Y, AND ORIGIN Z, AND CENTER DOMAIN	8
PERIODICITY	9
PORE/MATRIX MATERIAL AND MATRIX DENSITY	11
GENERATION AND OVERLAP MODE	12
ALLOW FIBER OVERLAP	12
WITHOUT (REMOVE) FIBER OVERLAP	12
PROHIBIT FIBER OVERLAP	13
USE ISOLATION DISTANCE	14
PROHIBIT OVERLAP WITH CURRENT STRUCTURE	14
STOPPING CRITERION	15
FIXED OBJECT NUMBER	16
OBJECT SOLID VOLUME PERCENTAGE	16
GRAMMAGE	16
MAXIMAL RUN TIME	17
TEMPERATURE	18
RANDOM SEED	18
Fiber Options	19
PERCENTAGE OF FIBER TYPE AS COUNT, VOLUME, OR WEIGHT	20
DENSITY	20
MATERIAL	21
FIBER TYPE	22
FIBER CROSS-SECTION	22
FIBER PARAMETERS	24
FIBER	31
ORIENTATION	34
SHAPE	37
TORSION	44
Fiber Overlap	46
Result Options	49
LAY-DOWN CELLULOSE FIBERS	50
Lay Down Options	51
LAY DOWN IN CURRENT DOMAIN AND KEEP CURRENT OBJECTS / STRUCTURE	51
DOMAIN PARAMETERS	52
NX, NY, AND VOXEL LENGTH	53
ORIGIN X, ORIGIN Y, AND ORIGIN Z, CENTER DOMAIN, AND PERIODICITY	54
PORE/MATRIX MATERIAL AND MATRIX DENSITY	54
GENERATION AND OVERLAP MODE	54
STOPPING CRITERION	55
TEMPERATURE	55
RANDOM SEED	55
Fiber Options	57

Fiber Motion	58
Result Options	58
ADD BINDER	59
General Options	60
STOPPING CRITERION	60
SOLID VOLUME PERCENTAGE	60
WEIGHT PERCENTAGE	60
GRAMMAGE	61
CONTACT ANGLE	62
BINDER ANISOTROPY FACTOR	63
PERIODICITY	63
STOP ITERATION BY	63
APPLY SOLID VOLUME PERCENTAGE / WEIGHT PERCENTAGE / GRAMMAGE CORRECTION AFTER ITERATIONS	64
Binder Distribution	66
ADD FILLER	68

GENERATING PAPER STRUCTURES WITH **PAPER**Geo

PaperGeo generates digital models of cellulose, elliptical, circular, and rectangular paper fibers, which model realistic organic paper structures. The two available paper generation processes are to **Create Cellulose Fibers** and to **Lay-Down Cellulose Fibers** by themselves or on an existing structure.

PaperGeo also models the common practice of adding binder and filler used in the paper industry.

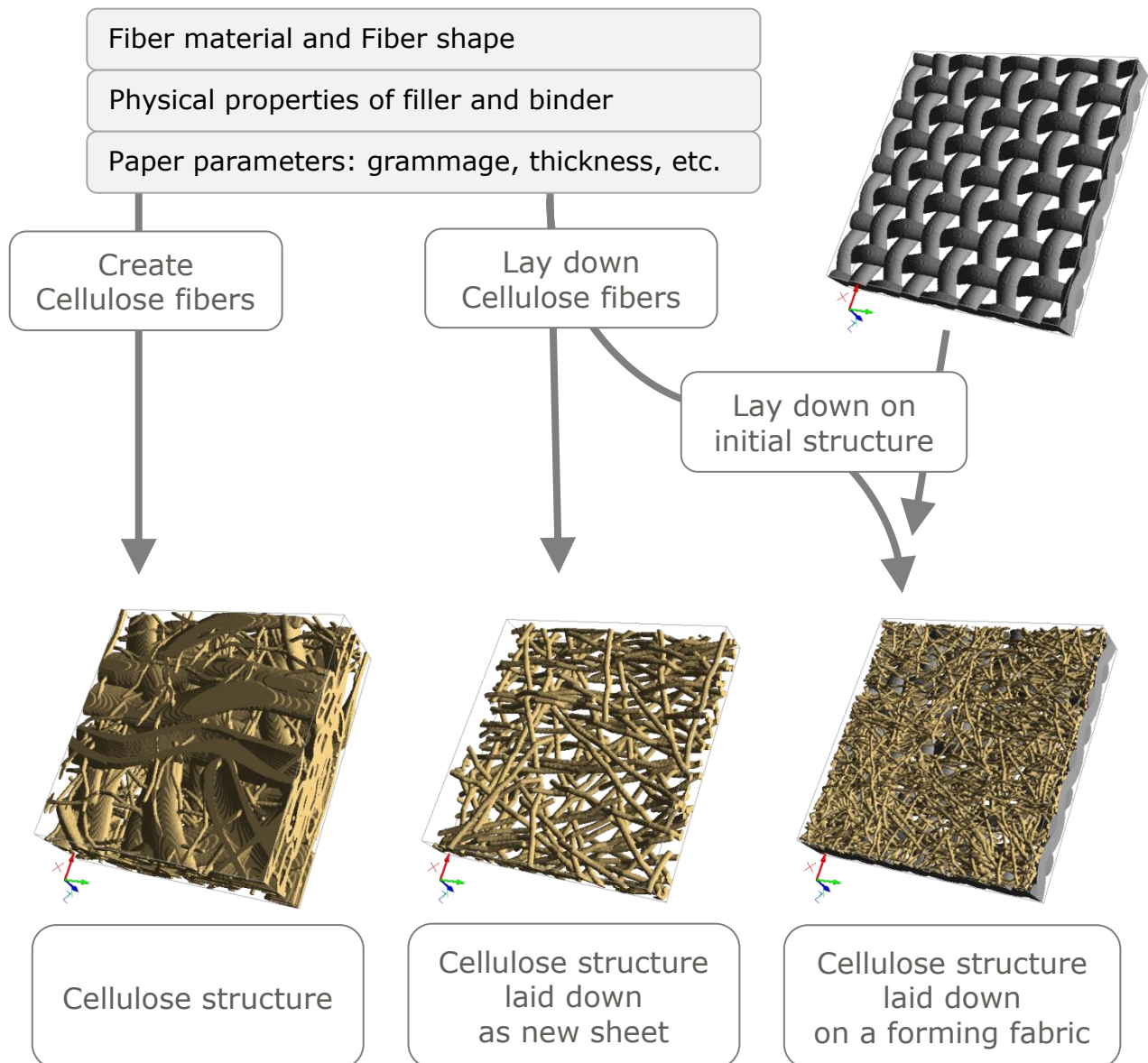

Paper structures modelled with **PaperGeo** may be the starting point to compute material properties of user-designed paper structures with other **GeoDict** modules for digital material analysis such as **FilterDict**, **PoroDict**, **MatDict**, **ElastoDict**, **FlowDict**, etc.

PAPERGEO SECTION

PaperGeo starts when selecting **Model** → **PaperGeo** in the Menu bar. The heading **PaperGeo** appears above the module section, on the left bottom of the GeoDict GUI.

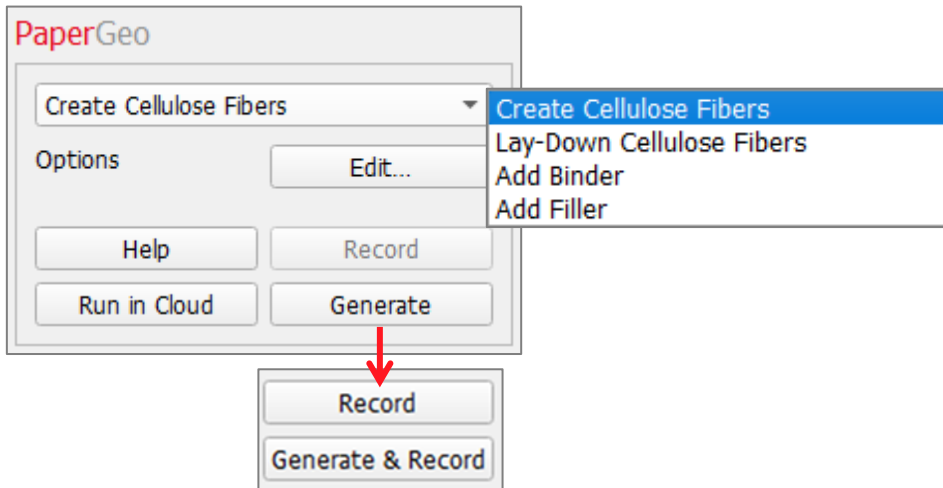

PaperGeo can be used to:

- **Create Cellulose Fibers**, forming paper structures of desired thickness and grammage
- **Lay-Down Cellulose Fibers**, forming a new paper structure e.g. by a lay-down process on a forming fabric.
- **Add Binder**, adding material in the shape of a concave meniscus in locations where fibers in the structure model are close together. The addition of binder in paper structures can be modeled in this way.
- **Add Filler**, adding spherical particles to coat the paper structure, or to replace fibers, binder or other materials.

To use any of these options, select the mode from the pull-down menu and then enter the necessary parameters through the **Edit ...** button located in its panel.

Clicking the **Generate** button at the bottom of the **PaperGeo** section starts the program's generation run. The structure is created and shown in the **Visualization** area. Macro files are recorded and saved when selecting **Macro** → **Start Macro Recording...** in the Menu bar. When recording a macro, **Record** becomes active and **Generate** changes to **Generate & Record**.

Click **Run in Cloud** to run it in the GeoDict cloud, see the [High Performance Computing](#) chapter of the GeoDict User Guide for details. If interested in cloud simulations contact Math2Market to apply for a GeoDict cloud license.

The modes **Create Cellulose Fibers** and **Lay-Down Cellulose Fibers** generate an entirely new paper structure, or a new paper structure based on the structure currently in memory. The other modes (**Add Binder** and **Add Filler**) require a valid initial structure.

For **Create Cellulose Fibers** and **Lay-Down Cellulose Fibers**, a customized **Result File Name (*.gdr)** should be entered to differentiate the results of sets of PaperGeo generations. The resulting *.gdr (GeoDict Result) file is placed inside the chosen project folder.

When running projects worth archiving, it is useful to save many files with information about the structure generation process. Thus, in addition to the *.gdr file, the project folder may optionally contain a variety of saved files from the PaperGeo run in the formats *.gdt (GeoDict File), *.gad (GeoDict analytic data), *.py (GeoPy macro files), and *.gps (GeoDict Project Settings file). The structure model can be saved in Binary file format *.gdt and *.raw or ASCII file format *.gad and *.les by selecting **File → Save Structure as...** in the Menu bar.

If you save the parameters in the **Options** dialog boxes into *.gps files, you can reload them at will.

Remember to restore and reset your (or GeoDict's) default values through the icons at the bottom of the dialog boxes when needed and/or before every PaperGeo run. Rest the mouse pointer over an icon to see a Tooltip showing the icon's function.



CREATE CELLULOSE FIBERS

After choosing **Create Cellulose Fibers** and clicking the **Create Options' Edit...** button, the **Create Cellulose Fibers Options** dialog box opens.

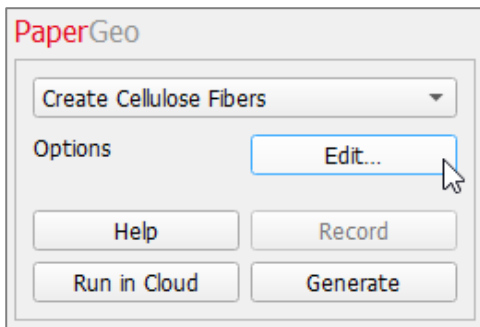

At the top left of the dialog box, the name for the files containing the generation results can be entered in the **Result File Name (*.gdr)** box. The default name can be kept, or a new name can be chosen fitting the current project.

The available units (**m**, **mm**, **µm**, **nm**, and **Voxel**) are selectable from the pull-down menu at the top right of the dialog. When the units are changed, the entered values are adjusted automatically.

The options are organized into four tabs:

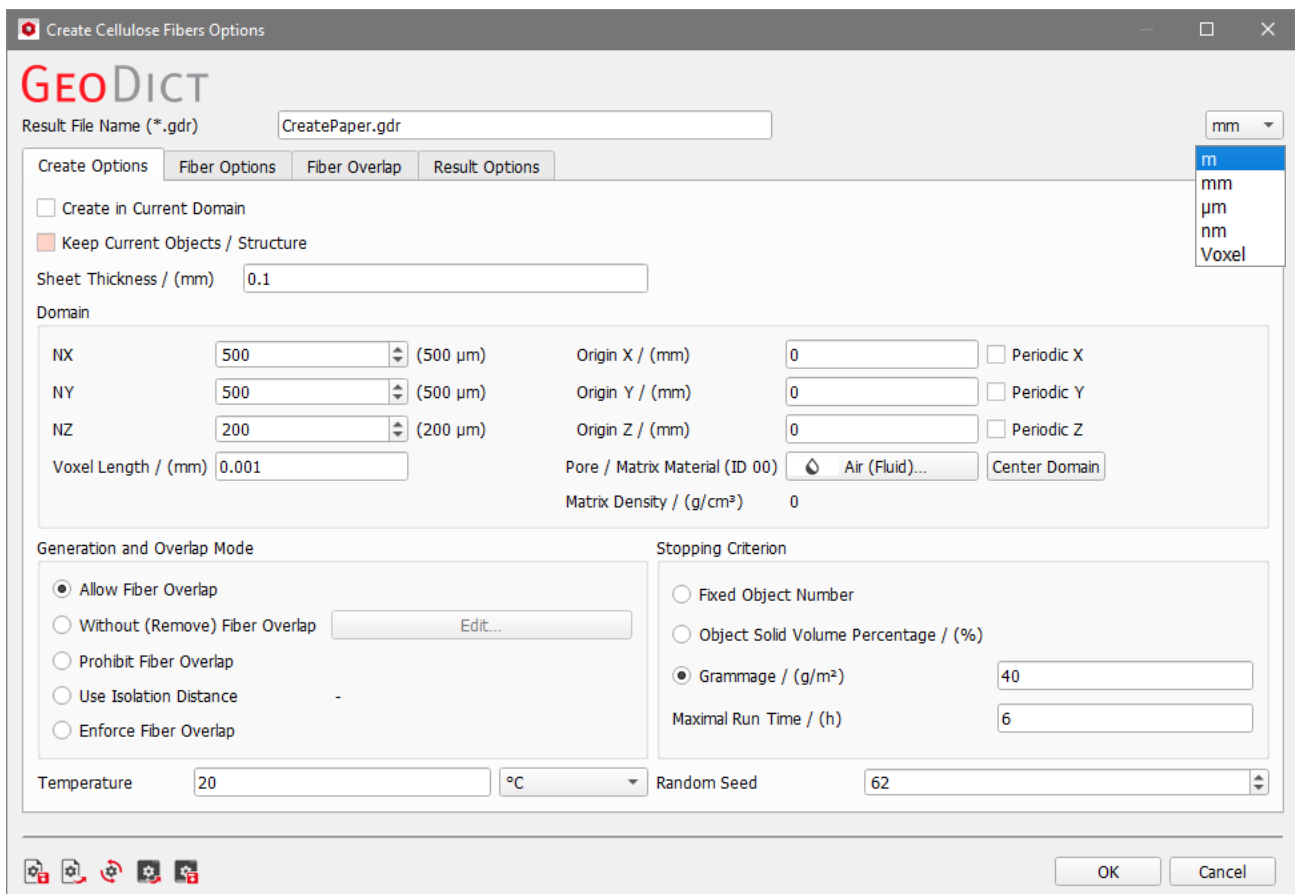

- The **Create Options** determine the general properties of the resulting structure model, such as size, position, resolution, and solid volume percentage.
- The **Fiber Options** define the geometrical properties of individual fiber types such as cross-section, length, and orientation. Up to eight different types can be used in one structure.
- The **Fiber Overlap** tab contains options dealing with how to define the material ID in locations where objects in the structure overlap. The overlap locations may exhibit other properties than those of the original materials.

- The **Result Options** determine if and how the resulting geometry is saved.

The result files are saved in the chosen project folder (**File** → **Choose Project Folder**, in the Menu bar). If a **GeoDict** result file (*.gdr) with the given name already exists in the project folder, a warning message is shown at the start of the creation process. The user can either decide to rename the chosen file name to a new one, to cancel the generation process, to overwrite or to back up the old file. When nothing is selected, GeoDict uses the Back-Up option after a waiting time.

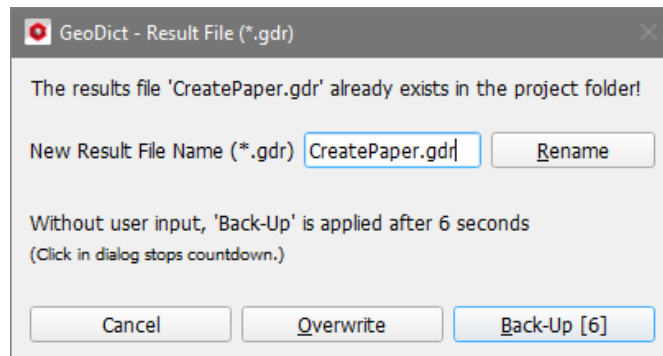

CREATE OPTIONS

The general properties of the paper structure are entered under the **Create Options** tab. These parameters are grouped into the panels **Domain**, **Generation and Overlap Mode**, **Stopping Criterion** and five single options.

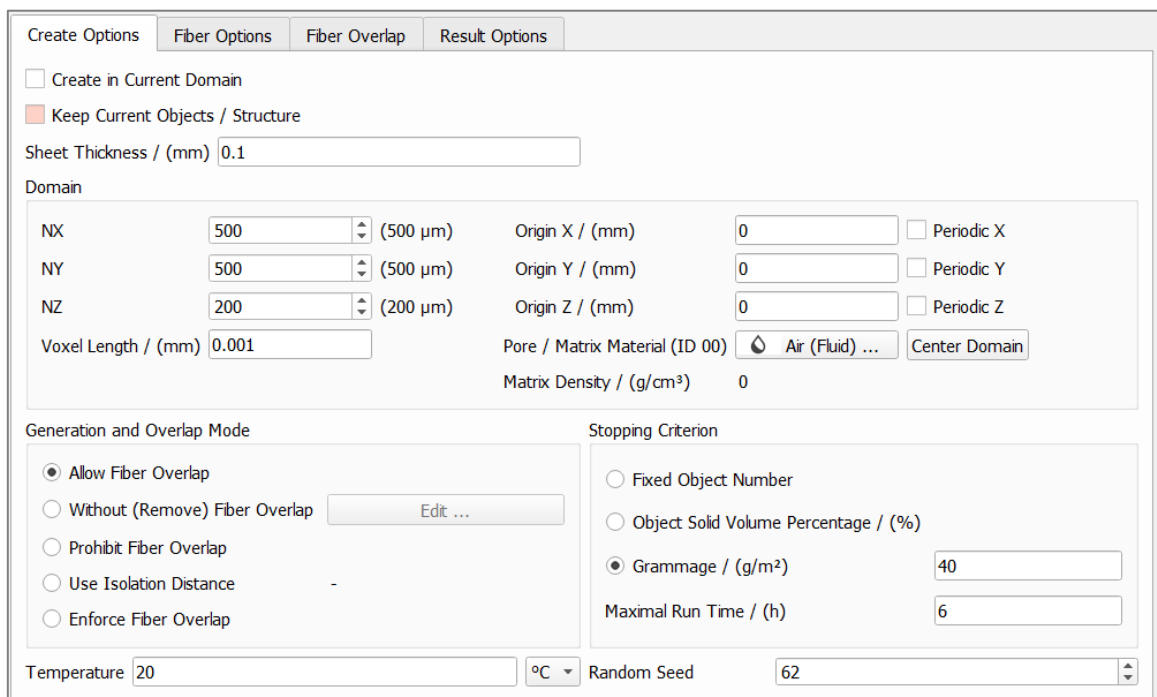

CREATE IN CURRENT DOMAIN AND KEEP CURRENT OBJECTS / STRUCTURE

When checking **Create in Current Domain**, the structure currently in memory, is considered during the generation of the paper structure. Additionally, when **Keep Current Objects/Structure** is checked, the structure in memory is kept and combined with the newly generated paper structure.

This feature is used in combination with checking **Prohibit Fiber Overlap** or **Prohibit Overlap with Current Structure** (see [page 12](#)) in the **Overlap Mode** panel. In this

way, the user can make the paper fibers cover and mold a structure in memory (for example a weave) and decide if the structure should be kept or not.

Once **Create in Current Domain** is checked, the parameters grouped under the **Domain** panel cannot be modified, including the voxel length, because they are taken from the structure already in memory.

Prohibit Overlap with Current Structure can be checked to avoid the paper fibers entering the weave, but the fibers can overlap each other. When they exist, the regions of fiber overlap are assigned to the next material ID (here shown in orange).

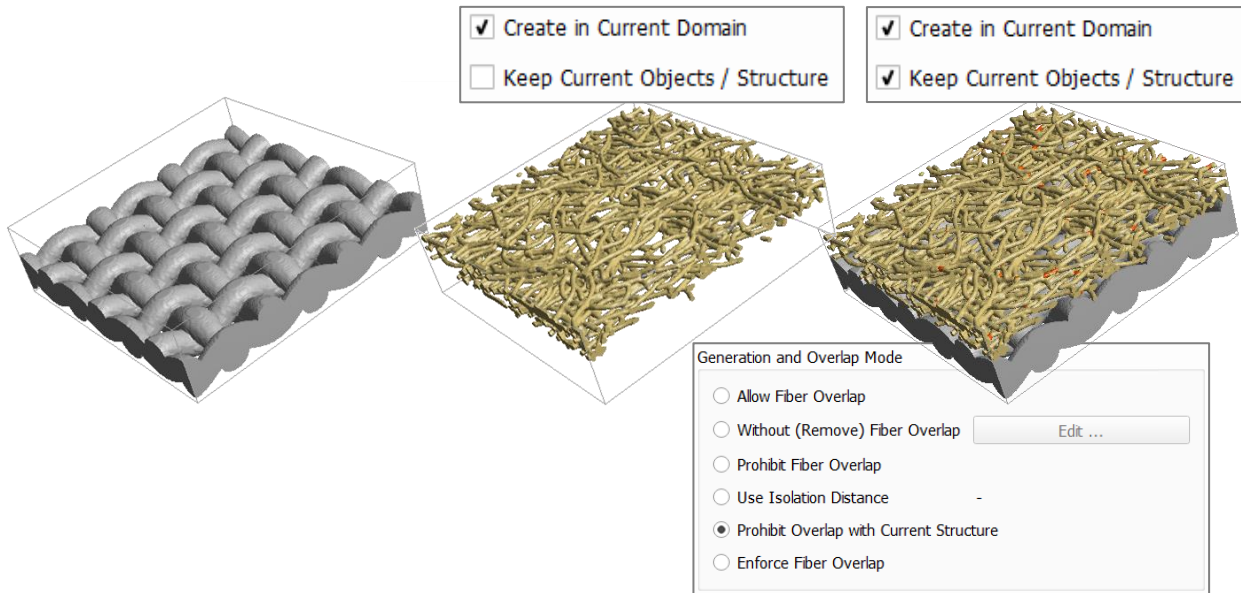

The more restrictive **Prohibit Fiber Overlap** should be checked if the fibers should not overlap each other nor the weave.

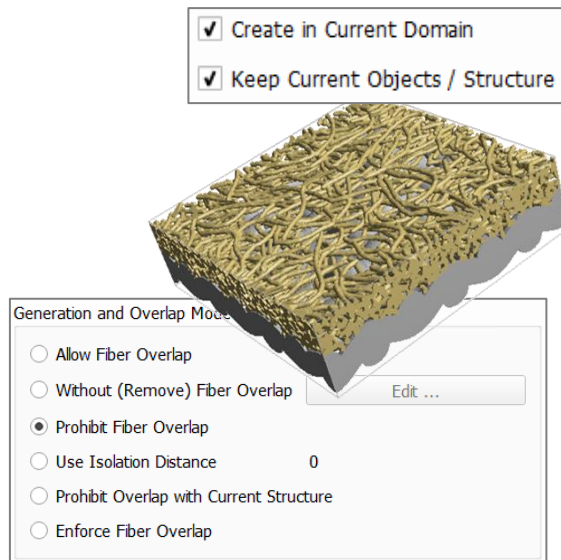

The **Sheet Thickness** value defines the thickness of the paper sheet, i.e. the height of the area (Z-direction) in which the fibers are placed. If the value is set higher than the height of the domain, it is discarded, and the fibers are placed inside the domain.

In the following examples, the sheet thickness is increased from 50 μm , to 100 μm and then, to 200 μm . The size of the domain remains the same (height in Z-direction: 200 μm) but the paper structure appears more voluminous.

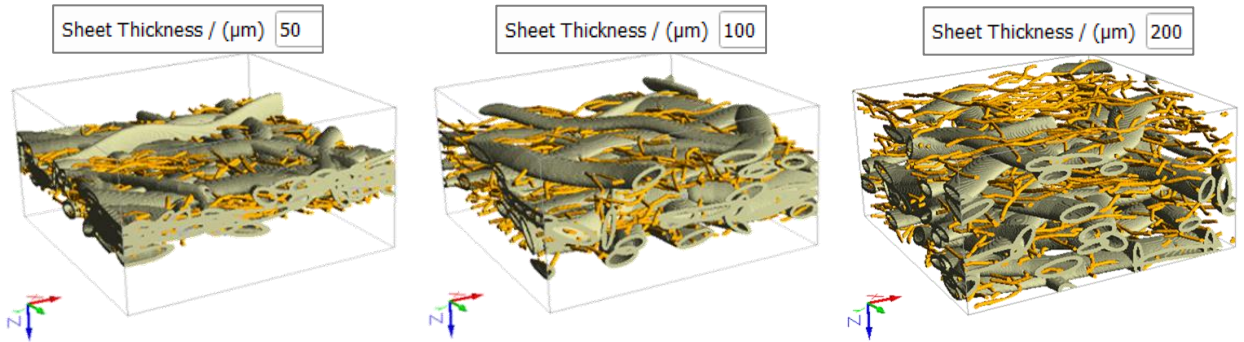

DOMAIN

The **Domain** panel contains the parameters defining the structure size (**NX**, **NY**, and **NZ**) in combination with the resolution (**Voxel Length**), as well as the **Origin** parameters, the **Periodicity** check boxes, the **Center Domain** button, and the **Pore/Matrix Material** and **Matrix Density** selection.

Domain					
NX	500	(500 μm)	Origin X / (μm)	0	<input type="checkbox"/> Periodic X
NY	500	(500 μm)	Origin Y / (μm)	0	<input type="checkbox"/> Periodic Y
NZ	200	(200 μm)	Origin Z / (μm)	0	<input type="checkbox"/> Periodic Z
Voxel Length / (μm)	1		Pore / Matrix Material (ID 00)	Air (Fluid) ...	<input type="button" value="Center Domain"/>
			Matrix Density / (g/cm ³)	0	

NX, NY, NZ, and Voxel Length

The internal representation of a structure in **GeoDict** consists of rectangular 3D arrays of equally sized boxes, hereafter called volume elements or **voxels**.

NX, **NY**, and **NZ** are the number (N) of voxels in X, Y and Z directions. The **Voxel Length** is the size of one voxel in the chosen units. Varying the values for **NX**, **NY**, and **NZ** has the effect of changing the size of the domain in the given direction.

Sheet Thickness / (μm)	100	
Domain		
NX	400	400 μm
NY	400	400 μm
NZ	400	400 μm
Voxel Length / (μm)	1	

Sheet Thickness / (μm)	100	
Domain		
NX	400	400 μm
NY	400	400 μm
NZ	200	200 μm
Voxel Length / (μm)	1	

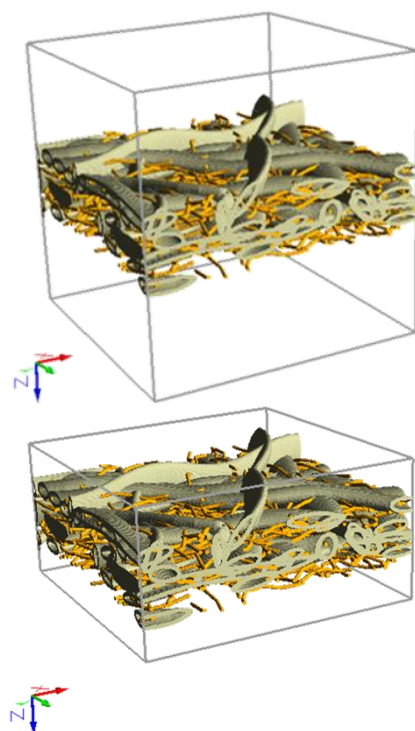

Low values for the voxel length in combination with high values for **NX**, **NY** and **NZ** result in a higher resolution, but also in a higher computational time. After setting the values of **NX**, **NY**, and **NZ**, and **Voxel Length**, the physical structure size is automatically displayed in the chosen units (here μm).

Observe in the figures below how starting with **NX=200**, **NY=200**, **NZ= 200** ($200 \times 200 \times 200 \mu\text{m}^3$, at voxel length $1 \mu\text{m}$), and decreasing the **Voxel Length** from $1 \mu\text{m}$ to $0.5 \mu\text{m}$, has the effect of refining the structure by increasing the resolution but decreases the size of the volume to $100 \times 100 \times 100 \mu\text{m}^3$.

Sheet Thickness / (μm)	100
Domain	
NX	200 200 μm
NY	200 200 μm
NZ	200 200 μm
Voxel Length / (μm)	1

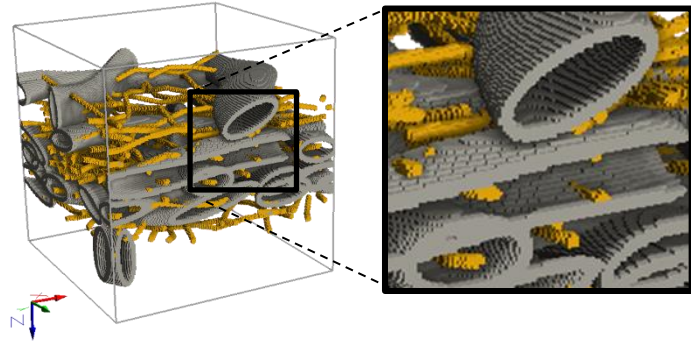

Sheet Thickness / (μm)	100
Domain	
NX	200 100 μm
NY	200 100 μm
NZ	200 100 μm
Voxel Length / (μm)	0.5

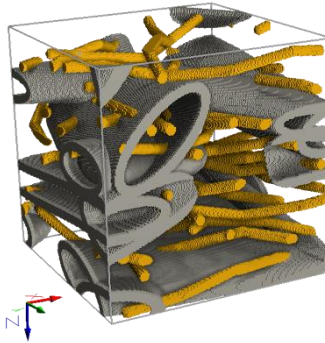

By setting **NX=400**, **NY=400**, **NZ= 400**, to restore the size of the volume to the original $200 \times 200 \times 200 \mu\text{m}^3$, the original structure is created at higher resolution.

Sheet Thickness / (μm)	100
Domain	
NX	400 200 μm
NY	400 200 μm
NZ	400 200 μm
Voxel Length / (μm)	0.5

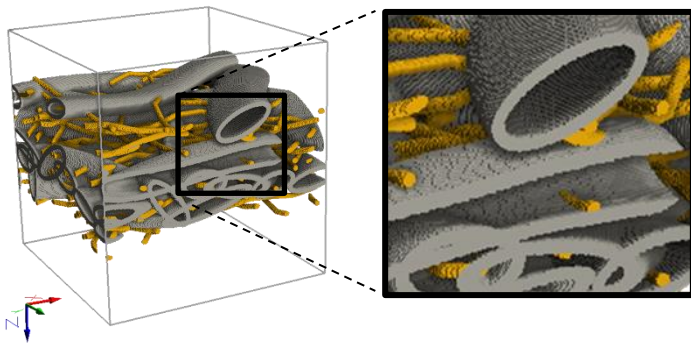

Origin X, Origin Y, and Origin Z, and Center Domain

The **Origin X**, **Origin Y**, and **Origin Z** parameters, together with the **Center Domain** button, determine the placement of the structure in the physical space.

Zero values for Origin X, Origin Y, and Origin Z mean that the point with (0, 0, 0) coordinates is located at the lower left corner of the structure. To enter values for **Origin X**, **Origin Y**, and **Origin Z** is useful in applications that call for exact structure coordinates.

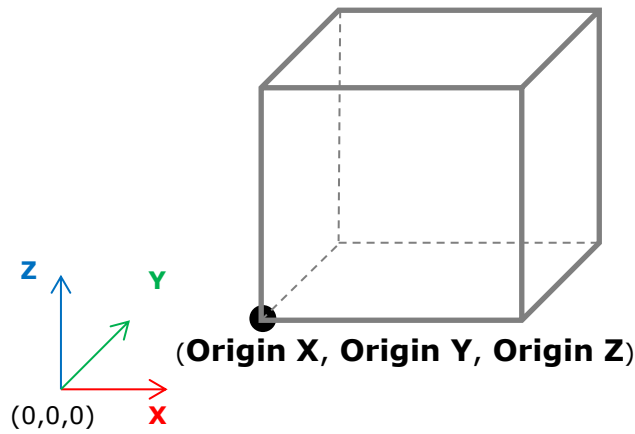

When clicking the **Center Domain** button, the origin is placed so that the point with (0, 0, 0) coordinates lies in the center of the structure.

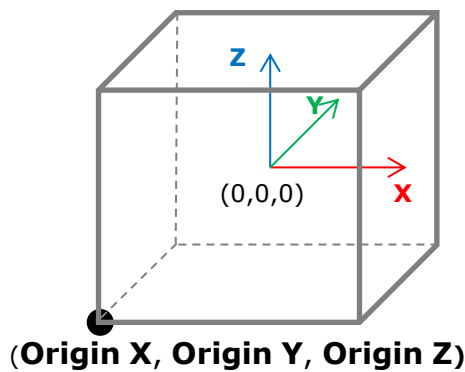

Periodicity

The periodicity of the paper structure is determined by checking or un-checking the **Periodic X**, **Periodic Y**, and **Periodic Z** boxes in one or several directions.

Periodicity has the effect that the fibers ending on one side of the domain reappear in the opposite side, so that when several domains with periodic fibers are combined, the structure emerges as a repetitive complex.

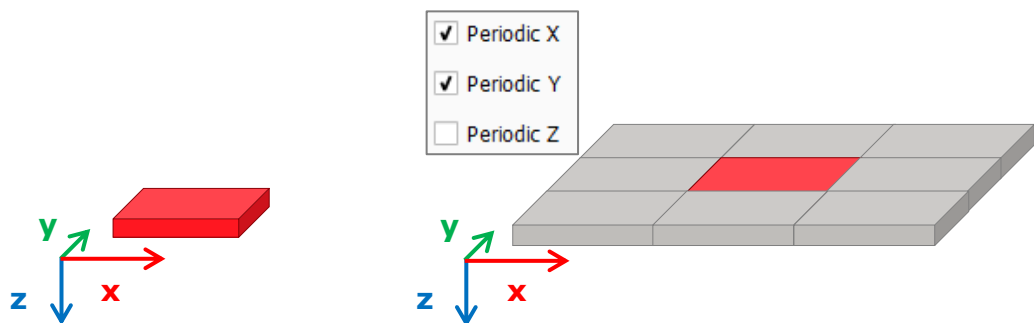

A warning message is displayed when trying to generate a periodic structure with **fibers that are longer than the domain size**, since they might overlap themselves.

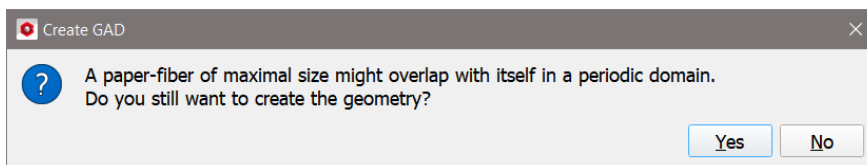

Generating paper structures with PaperGeo

An error message appears when trying to generate a periodic structure with **Infinite fibers**. To avoid this error, go to **Fiber Options** and remove the **Infinite fibers** or, alternatively, do not choose to generate with periodicity.

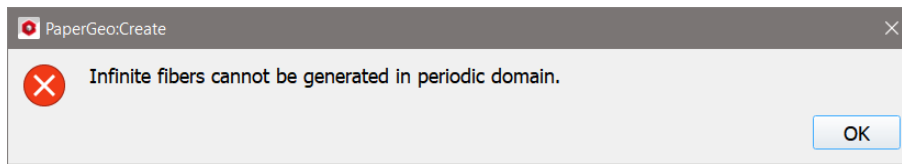

Observe the effect that checking or leaving unchecked the **Periodic X** and **Periodic Y** boxes has on the periodicity of a generated fibrous structure. View the paper structure in 3D Rendering and in 2D Cross-Section.

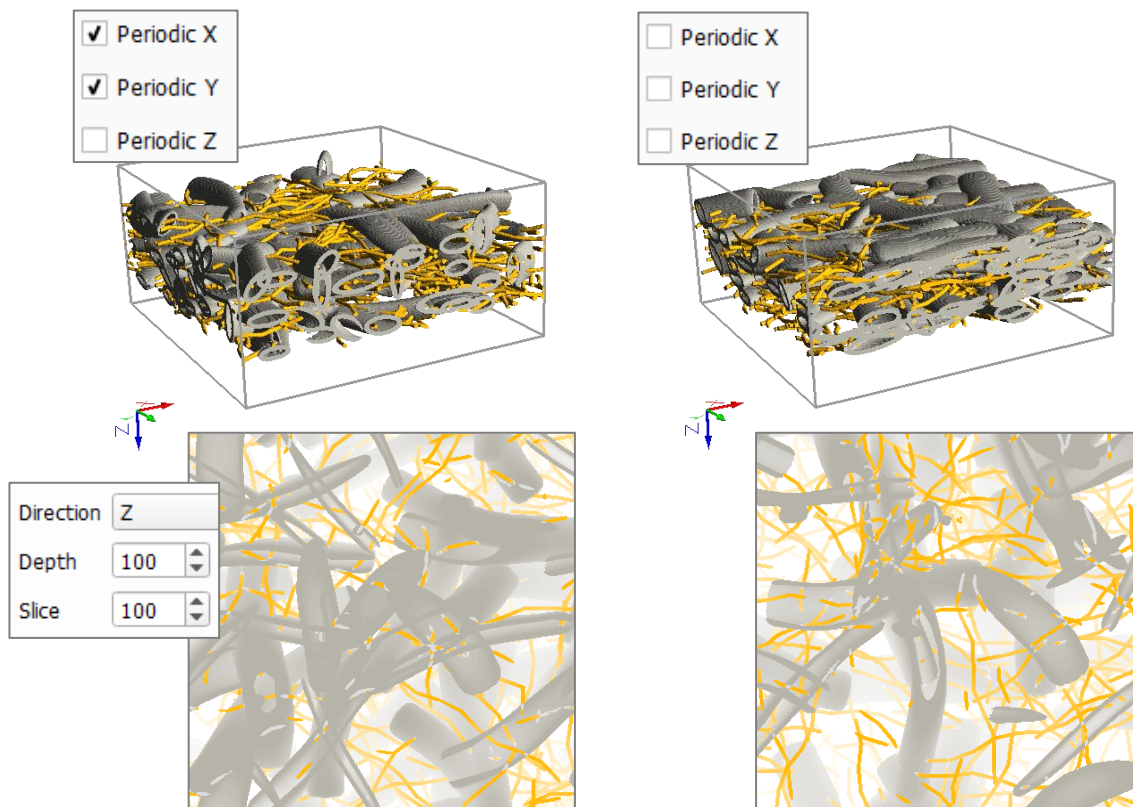

The effect is readily observed when repeating the sample structure with **ProcessGeo** (**Model** → **ProcessGeo** – **Process** → **Repeat**: X-, Y-, Z- 400 voxels) and viewing it again in 2D View from the Z-direction.

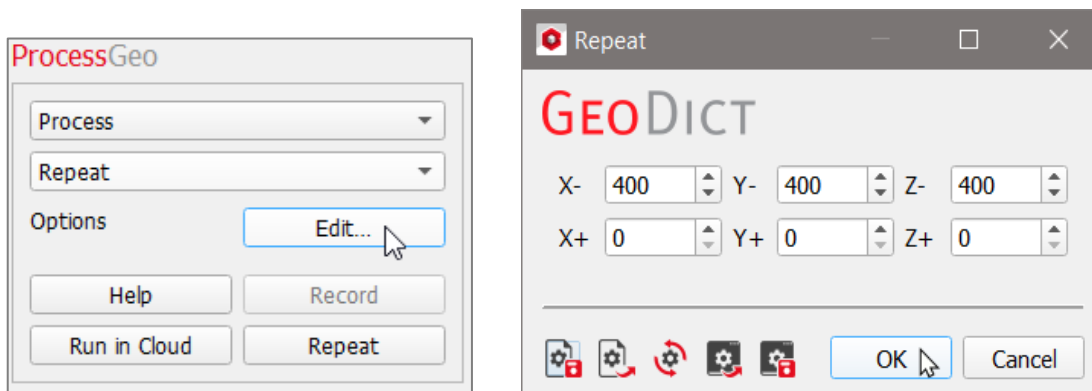

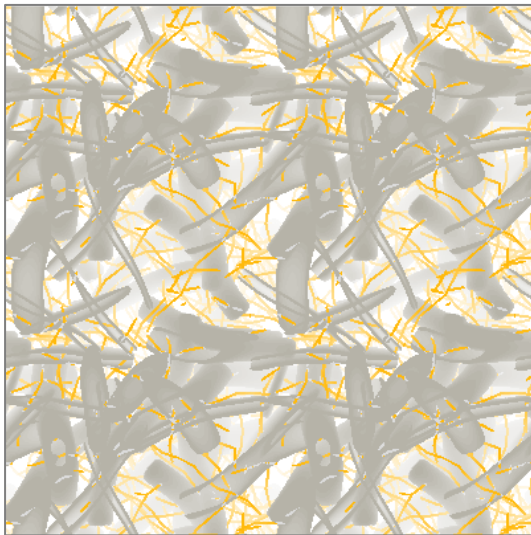

In the periodic structure, the paper fibers connect to each other across the repeated unit cells.

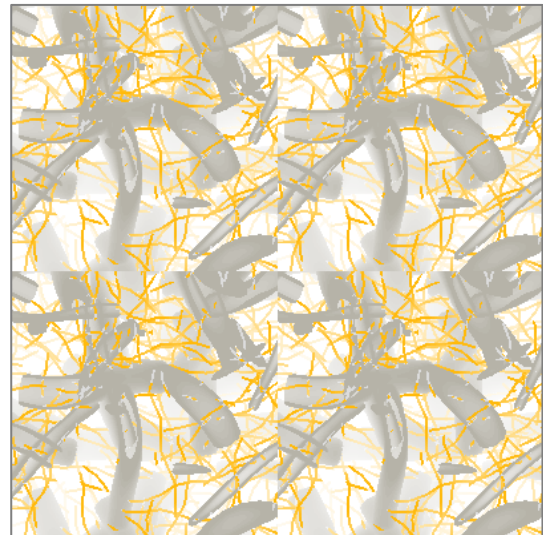

In the non-periodic structure, the paper fibers end at the edge of the unit cell. A divisor line is apparent there, and the structure consists of a mosaic of disconnected unit cells.

Pore/Matrix Material and Matrix Density

Choose the material of the matrix around the fibers from the material selector.

When the default matrix material (Air) is chosen, the fibers are embedded in empty pore space. When the chosen pore/matrix material is a solid, the density of this material can be entered or is directly taken from the **GeoDict** Material Database.

Pore / Matrix Material (ID 00)	Air (Fluid) ...
Matrix Density / (g/cm ³)	0

Pore / Matrix Material (ID 00)	Manual (Solid) ...
Matrix Density / (g/cm ³)	0.27

The color representing the pore/matrix material can be made visible (default is invisible rendering) and changed through **Settings** → **Color & Visibility Settings** in the Menu bar.

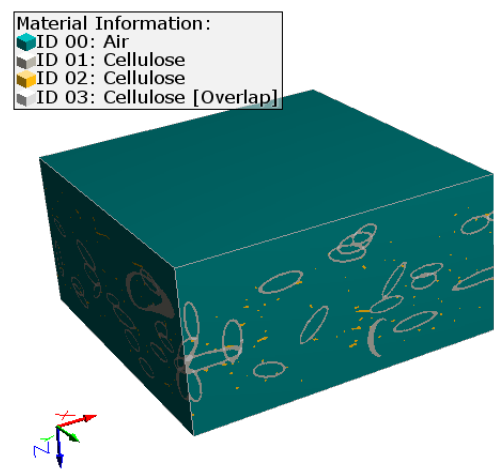
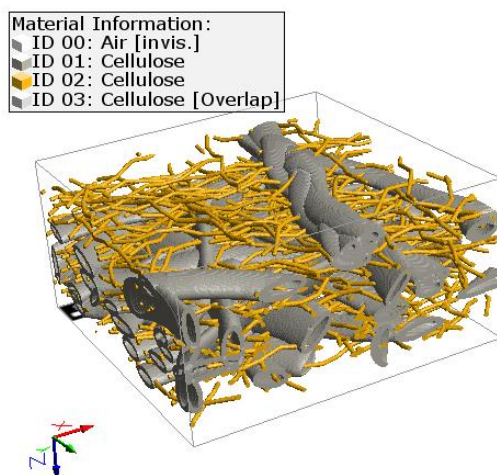

GENERATION AND OVERLAP MODE

The options in the **Generation and Overlap Mode** panel control the relative position among the generated fibers or between the newly created fibers and the structure currently in memory. After checking **Create in Current Domain**, one of the following options can be chosen: **Allow Fiber Overlap**, **Without (Remove) Fiber Overlap**, **Prohibit Fiber Overlap**, **Use Isolation Distance**, **Prohibit Overlap with Current Structure** (shown when a structure is in memory and Create in Current Domain is checked), or **Enforce Fiber Overlap**.

Allow Fiber Overlap

Fibers may overlap when **Allow Fiber Overlap** is selected. The overlap is shown here in orange.

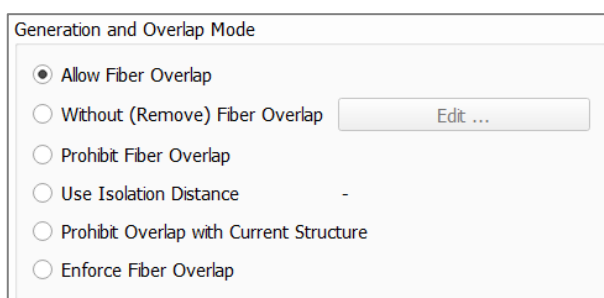

Without (Remove) Fiber Overlap

Checking **Without (Remove) Fiber Overlap** eliminates existing overlaps *after* the generation step. The user should consider that:

- Overlaps can be removed from:
 - Periodic structure models with fiber lengths smaller the domain size. If fibers longer than the domain size are present in the model, they might overlap with themselves. This type of overlap cannot be removed.
 - Non-periodic structure models with arbitrary fiber length (short or infinite fibers).
- The statistical properties might change slightly.
- The way in which the overlap removal occurs can be controlled through the **Remove Overlap Options** accessible via the **Edit ...** button.

In the **Remove Overlap Options** dialog, the following parameters can be set:

- **Iterations**: Defines after how many iterations the removal stops.
- **Iterations SVP Unchanged**: The removal stops if the **SVP** (**S**olid **V**olume **P**ercentage. See page [16](#)) remains unchanged after the given number of iterations.
- **Overlap SVP / (%)**: Defines the final allowed **Overlap SVP**.
- **Allow Object Shifts**: Check if shifting fibers is an allowed operation for removal. Define the allowed **Number of Shifts** per iteration and the maximal **Shift Distance** per iteration. The fibers will be shifted in all directions.
- **Allow Object Rotations**: Check if rotating the fibers should be an allowed operation for removal. Define the maximal **Number of Rotations** allowed per

iteration. Objects will be rotated in all directions, where the maximal rotation angle per iteration is one degree.

- Allow Fiber Deformations:** Check if bending the fibers should be an allowed operation for overlap removal. Define the **Maximal Bending Angle** allowed between two segments. Each fiber consists of several segments. The center points of the segment connections are shifted in all directions, while the other shape parameters, as e.g. fiber length and segment length are kept constant. The maximal point shift distance is the same as for the object shift.

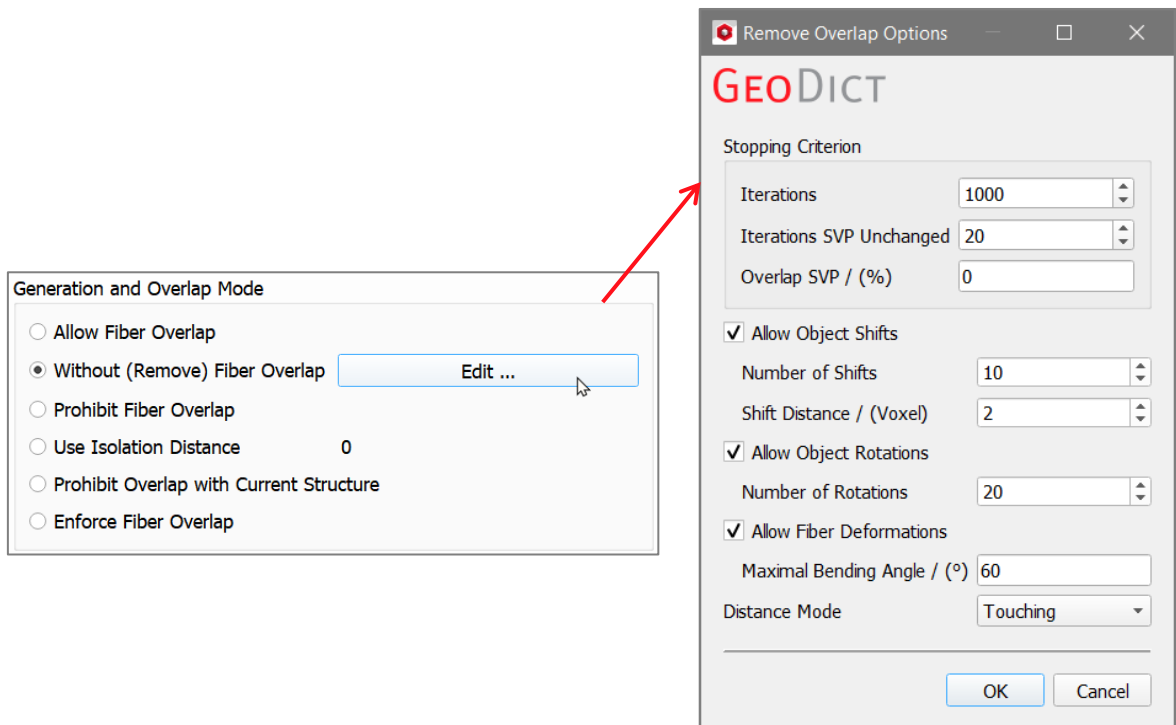

- Distance Mode:** The pull-down menu offers four options:
 - The fibers can be **Touching** (distance zero).
 - Enter a maximal **Defined Overlap** allowed for the fibers.
 - Enter a minimal **Defined Isolation** distance for the fibers.
 - Avoid Contacts** means a defined isolation of one voxel volume diagonal.

Prohibit Fiber Overlap

Fibers may touch but not overlap when **Prohibit Fiber Overlap** is selected.

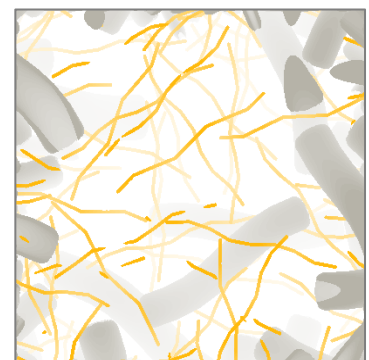
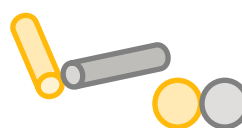
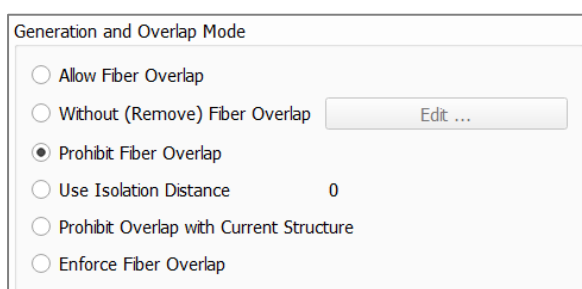

Use Isolation Distance

By selecting **Use Isolation Distance**, and inserting a positive value, the gaps between fibers have at least this preset distance.

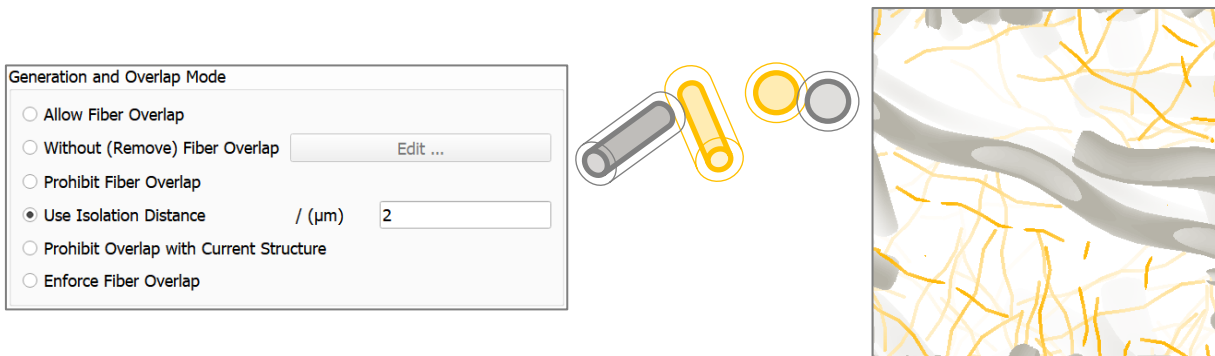

Negative values for the isolation distance are useful to model paper structures with synthetic fibers that melt together during the lay down, or natural fibers that deform at touching points during the generation of the paper sheet. Then, the distance between the centers of the fibers is less than the sum of the two radii.

When the option **Use Isolation Distance** is set to negative values (e.g. -10 μm), the effect is that the fibers may overlap with maximally 10 μm (the negative isolation distance). Here, the effect is that some fibers penetrate other fibers and pass through them. The overlaps between fibers are assigned to a new material ID and shown in a different color, which here is orange.

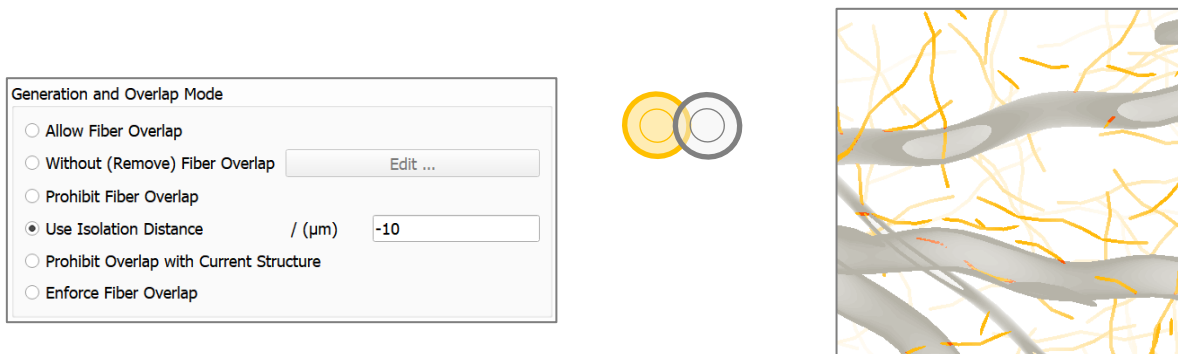

Prohibit Overlap with Current Structure

When choosing **Prohibit Overlap with Current Structure** (after checking Create in Current Domain), the fibers in the newly generated paper structure can intersect with each other but not with those of the already existing structure.

Observe this effect in a structure made of a woven screen over which a paper structure is generated. Whereas the paper fibers overlap with each other (in orange), they do not overlap with the pre-existing woven screen.

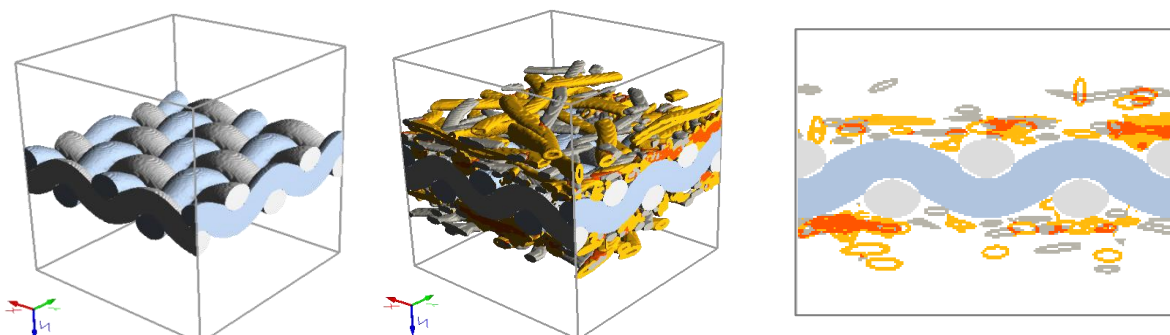

By checking **Enforce Fiber Overlap**, the structure's fibers are required to join each other, forming a large connected component. This effect is obvious when the **solid volume percentage (SVP)** of the structure is low (here 10%), i.e. the fibers do not already form a connected component.

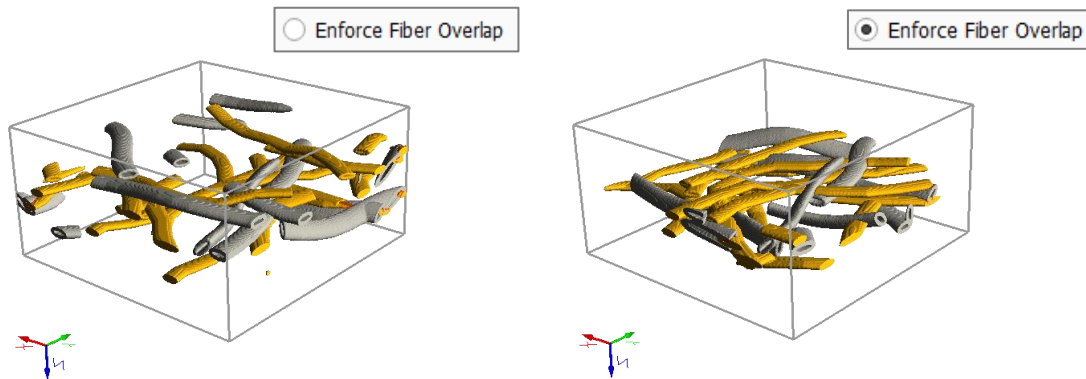

The algorithm under **Allow Objects Overlap** is fast, especially for big structures and, in most cases, leads to excellent results.

If the user chooses **Remove Objects Overlap**, the generation time may be longer when generating structures with high solid volume percentages.

Prohibit Fiber Overlap or **Prohibit Overlap with Current Structure** may be unfeasible when generating very dense papers since the positioning of new non-overlapping fibers might be geometrically impossible.

For the same reasons, with **Use Isolation Distance**, the generation time may be long, or the generation might be impossible depending on the chosen value for the isolation distance and the selected value for stopping criterion.

Generally, structures with overlapping fibers should be used for processes in the pore space, as filtration and flow simulation. For simulations of mechanical properties, papers without overlap should be generated.

STOPPING CRITERION

The parameters in the **Stopping Criterion** panel control when the generation process is stopped, and the material is "ready".

Stopping Criterion	
<input checked="" type="radio"/> Fixed Object Number	1000
<input type="radio"/> Object Solid Volume Percentage	
<input type="radio"/> Grammage / (g/m ²)	
Maximal Run Time / (h)	6

The available parameters are **Fixed Object Number**, **Object Solid Volume Percentage**, or **Grammage (g/m²)**.

Additionally, when the **Maximal Run Time (h)** has passed, the process is stopped even when the desired stopping criterion is not achieved.

Fixed Object Number

When **Fixed Object Number** is chosen as stopping criterion, PaperGeo places the given number of fibers in the structure and then the generation stops.

Observe the effect of setting a fixed number of objects (20, 100, or 500) as stopping criterion, for the generation of a paper structure with two fiber types. All other parameters are left untouched, including the default **Allow Fiber Overlap**. Note how the overlapping of fibers, shown in orange, increases with the number of objects present in the structure.

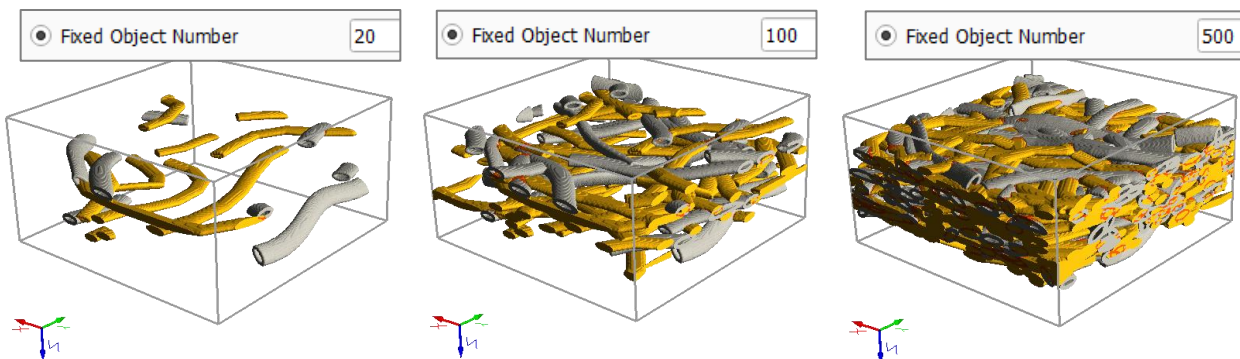

Object Solid Volume Percentage

The **Object Solid Volume Percentage** (SVP) determines the fraction of the total volume that the paper structure should have. Accepted values range from 0 to 100 %. For example, a structure with an **Object Solid Volume Percentage** of 40 consists of 40% fibers and 60% void space. Porosity is defined as $(1 - \text{SVP}/100)$.

Observe the difference in a structure when varying the solid volume percentage from 5%, to 20% and finally to 40%, while all other parameters are left unchanged. Note that the **Sheet Thickness** has not changed, so that the increase in SVP has the effect of producing a denser cellulose sheet.

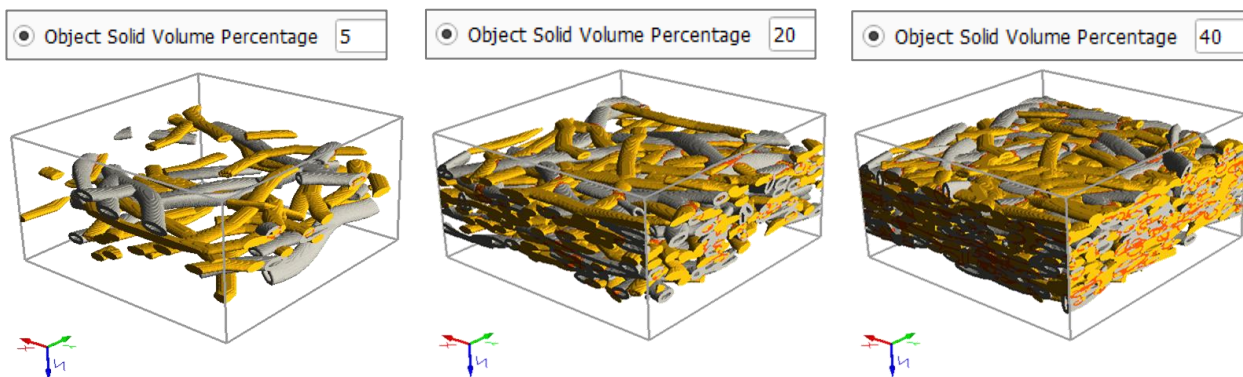

Grammage

The **Grammage** (g/m^2) determines the weight of the resulting paper/cellulose structure.

When **Grammage** is checked as stopping criterion (under the **Create Options** tab), the **Density** (g/cm^3) of the fiber material(s) can be seen in the materials panels under the **Fiber Options** tab or must be entered if Manual instead of a **Database Material** (such as cellulose) is chosen.

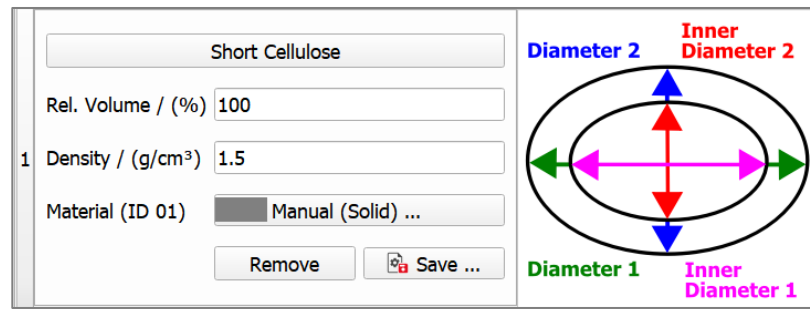

Observe the effect of increasing the **Grammage** from 15 to 40 g/m², whereas all other parameters are left unchanged.

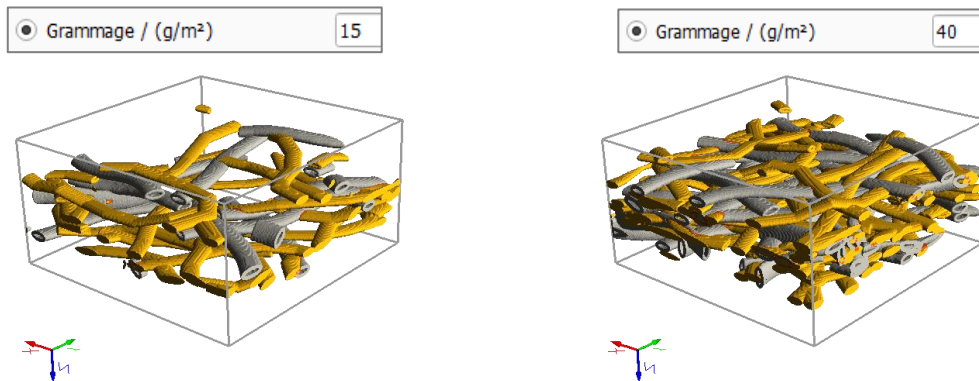

The relationship of the variables **Fixed Object Number**, **Object Solid Volume Percentage**, and **Grammage** can be observed in the Result Viewer of the result file, under the **Results - Report** subtab.

In this example, a **Count** (Fixed Object Number) of 50 corresponds to a **Volume** (Object SVP) of 6.05%, and a **Grammage** of 9.08 g/m².

Input Map Log Map Post Map Results Data Visualization Metadata					
Report Plots Map					
Absolute Object Distribution:					
	Count	Volume / (%)	Grammage / (g/m ²)	Density / (g/cm ³)	Weight / (%)
Total	realized: 50 target: 50 error: 0.00	realized: 6.05 target: --- error: ---	realized: 9.08 target: --- error: ---	realized: 0.0908 target: --- error: ---	realized: 0.00 target: --- error: ---
Object Type 1	realized: 10 target: --- error: ---	realized: 3.17 target: --- error: ---	realized: 4.75 target: --- error: ---	realized: 0.0475 target: --- error: ---	realized: 0.00 target: --- error: ---
Object Type 2	realized: 40 target: --- error: ---	realized: 2.88 target: --- error: ---	realized: 4.33 target: --- error: ---	realized: 0.0433 target: --- error: ---	realized: 0.00 target: --- error: ---

Stopping Criterion Error: 0 %

Maximal Run Time

The **Maximal Run Time** (h) becomes important when generating complex structures, for example with **Prohibit Fiber Overlap** or **Use Isolation Distance** and an elevated solid volume percentage. In those cases, the required number of fibers in the structure may become unattainable.

The paper structure generation is stopped after the time entered in **Maximal Run Time** has passed and the achieved structure is considered as the result. The analysis of the GDR result file shows the disparity between the achieved result values and the desired ones.

TEMPERATURE

When **Grammage** is chosen as **Stopping Criterion**, the temperature to be considered for the generation of the paper structure must be entered because the density of the structure's constituent materials might be temperature dependent.

Choose the temperature in Kelvin, Celsius, or Fahrenheit.

 °C
K
°C
°F

RANDOM SEED

Random Seed initializes the random number generator behind the structure generator. Changing its value produces different sequences of random numbers and hence, different realizations of the specified structure. If all settings are equal, generating with the same **Random Seed** value produces exactly the same structure, as shown by the **Structure ID** number in the Status section. The **Random Seed** is a non-negative integer number, it increases automatically with every generation run.

Varying the **Random Seed** allows generating different samples of the same paper structure for a series of experiments. In the following examples, all parameters are unchanged while the random seed is modified with every generation run (in this example: 1, 2, and 3).

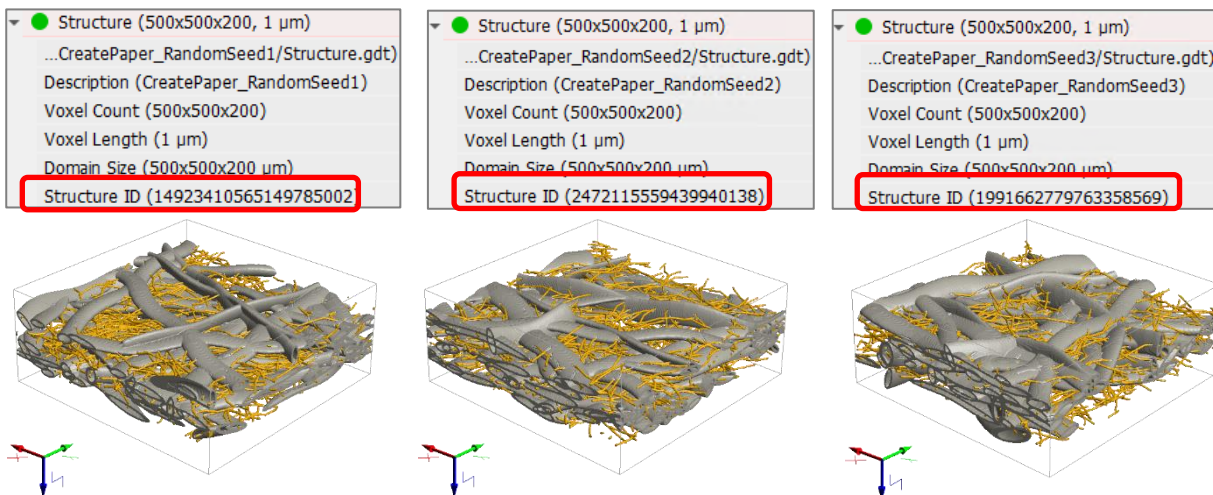

FIBER OPTIONS

The fibers for the generation of paper structures are organized and listed in panels.

For all fibers, the left column of the panel contains the name of the fiber type, the fiber percentage in the structure as **Count**, **Volume** or **Weight** percentage, and the fiber **Material**. When Grammage is chosen as Stopping Criterion, the material **Density** (g/cm^3) of that fiber type also appears. For materials included in the GeoDict Material Database, the density is automatically entered. For other materials (manual, user-defined), the density must be entered manually.

The middle column shows a drawing of the main geometrical properties of this fiber type.

In the right column, the geometrical properties or defining parameters of the particular fiber type can be entered. These geometrical properties include diameter, orientation, length, position, etc.

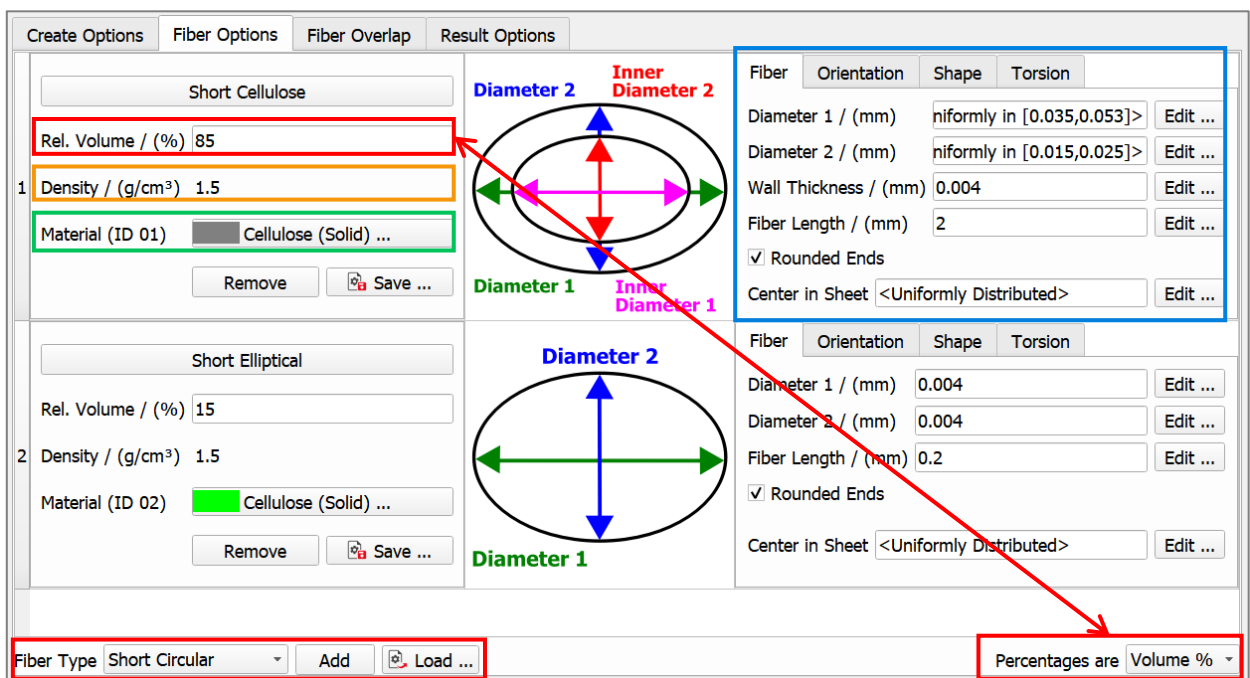

Short Cellulose and Short Elliptical are the two default **Fiber Types**. At the bottom left of the dialog box, clicking **Add** inserts other fiber types chosen from the **Fiber Type** pull-down menu (Short Circular, Infinite Cellulose, Infinite Rectangular, etc.). Unwanted fiber types can be discarded when clicking **Remove** in the left panel for that fiber type.

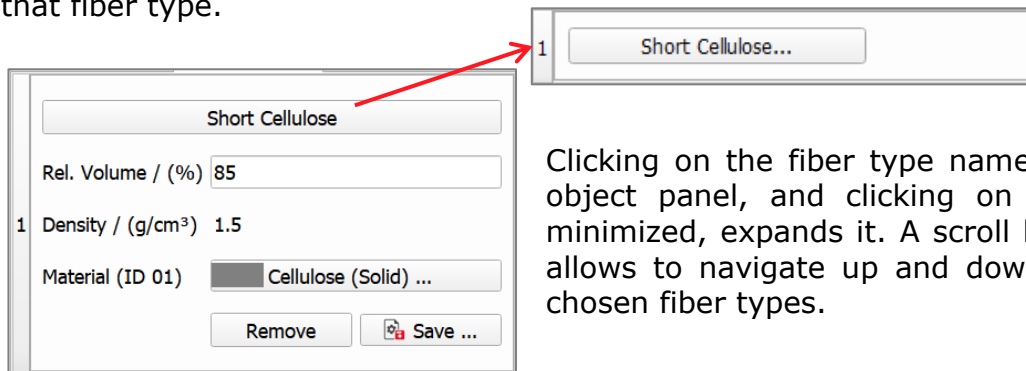

Clicking on the fiber type name minimizes the object panel, and clicking on it again when minimized, expands it. A scroll bar at the right allows to navigate up and down in the list of chosen fiber types.

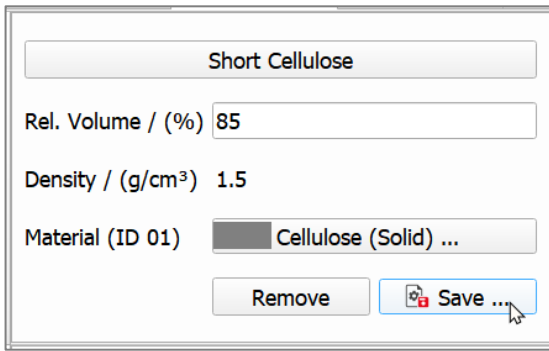

The settings for a proprietary fiber can be saved with all its options by clicking **Save...** and later reloaded by clicking **Load...**



PERCENTAGE OF FIBER TYPE AS COUNT, VOLUME, OR WEIGHT

The percentage of a certain fiber type can be specified as **Count %**, **Volume %**, and **Weight %**, as selected from the pull-down menu at the bottom right of the dialog box.

Note that, if the **Weight** option is chosen, the material density must be provided (or it is taken from the **GeoDict** material database) even when **Grammage** is not selected under the **Create Options** tab.

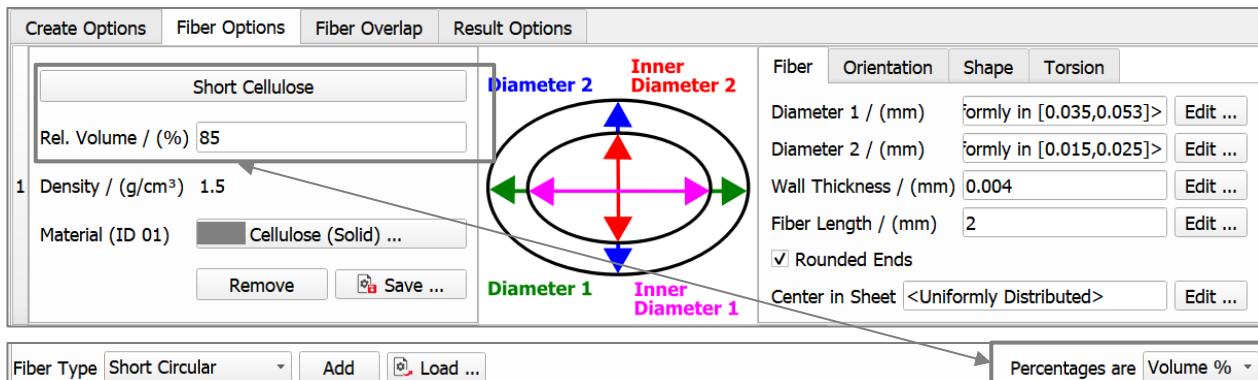

DENSITY

The fiber **Density**, given in g / cm^3 , is an intrinsic property of the selected fiber type, affecting the final weight of the paper structure. The density of fiber is intimately related to the **Grammage** (g/m^2) of the created paper structure. When denser fibers are used, and the grammage is unchanged, less fibers of this type appear in the paper structure.

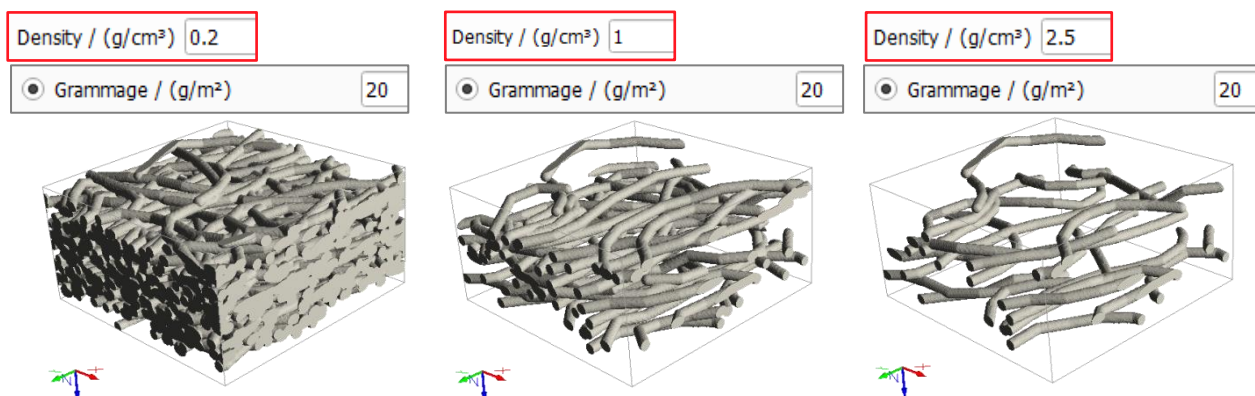

Vice versa, when the same fiber type is used but an increase in grammage should be achieved, the structure must contain more fibers.

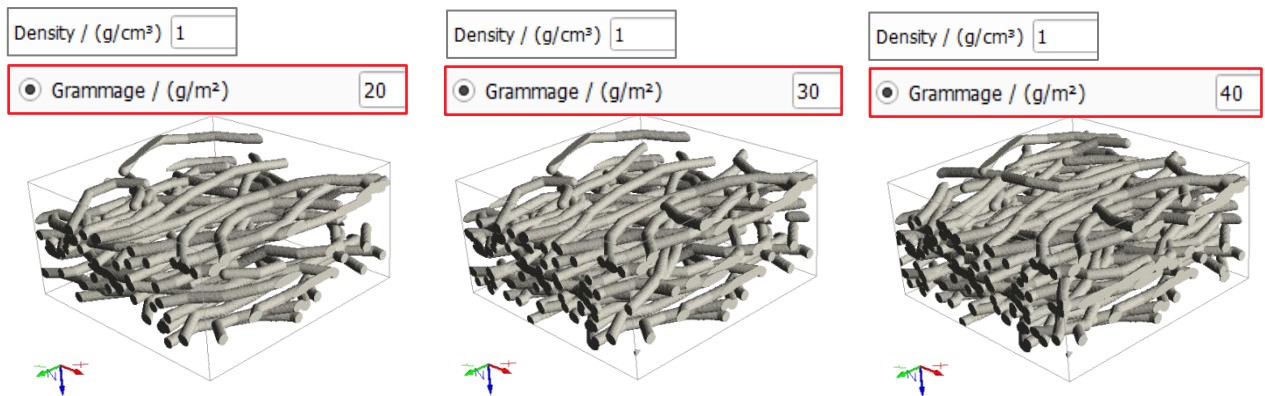

MATERIAL

Material designates the constituent material assigned to the fiber type used in the paper structure. The pull-down menu gives access to selecting the desired material from the **GeoDict** Material Database. When none of the materials available in the database fit the preferred specifications, **Manual** should be chosen.

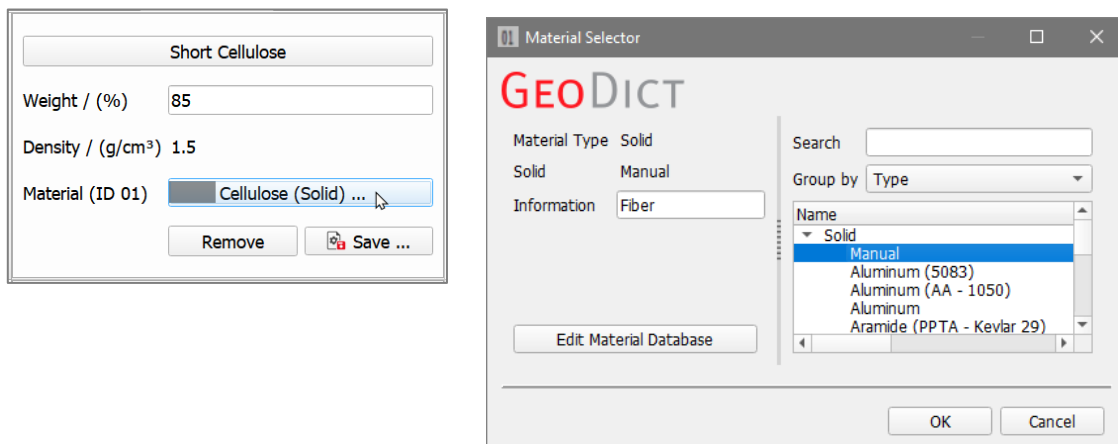

To match realistic material colors for visualization in a certain application, or to distinguish the constituting materials more easily, the colors of the materials can be changed through **Settings** → **Color & Visibility Settings** in the Menu bar, or by unfolding the **Color & Visibility** sidebar next to the GeoDict visualization area.

FIBER TYPE

The **Fiber Type** is selected from the pull-down menu at the lower left under the **Fiber Options**. After the selection, the fiber type is added to the **Fiber Options** by clicking **Add**. If the wrong fiber type has been added, it can easily be discarded by clicking **Remove**.

The following eight combinations of fiber cross-section with fiber length are available:

	Short	Infinite
Circular	Short Circular	Infinite Circular
Elliptical	Short Elliptical	Infinite Elliptical
Cellulose	Short Cellulose	Infinite Cellulose
Rectangular	Short Rectangular	Infinite Rectangular

Fiber cross-section

A drawing of the fiber cross-section is shown in the center column of each fiber type panel. The available fiber cross-sections and their defining parameters are:

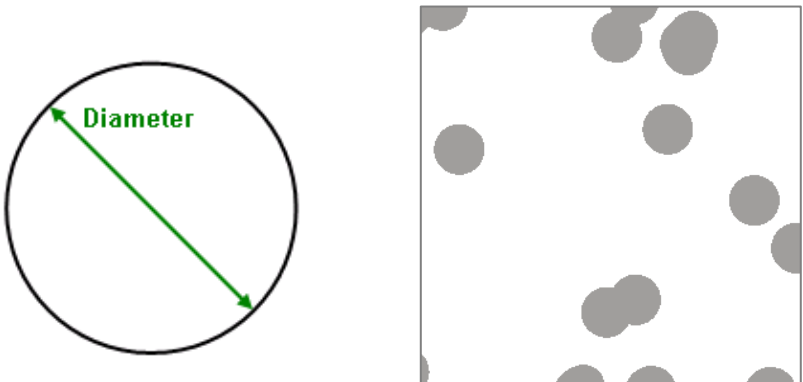
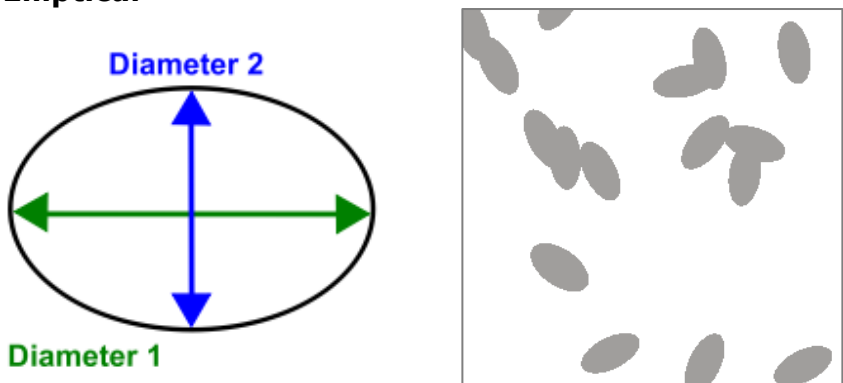
Cross-section	Defining parameters
<p>Circular</p> 	<p>Diameter / μm</p>
<p>Elliptical</p> 	<p>Diameter 1 / μm Diameter 2 / μm</p>

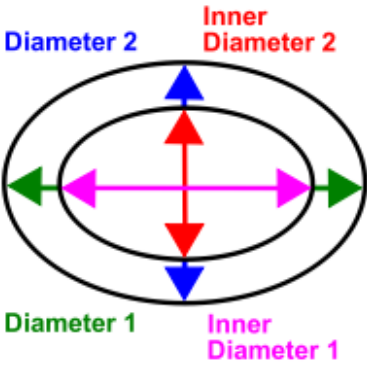
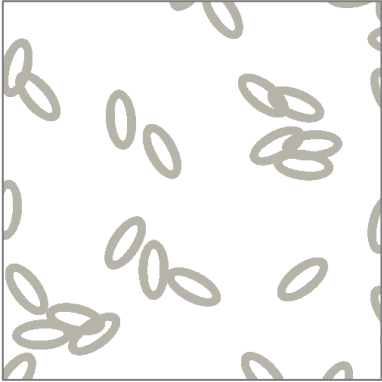
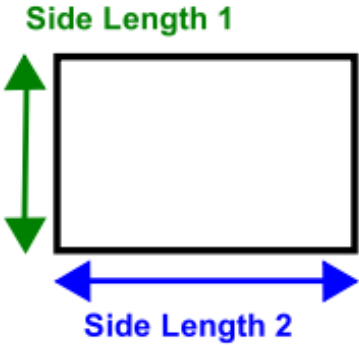
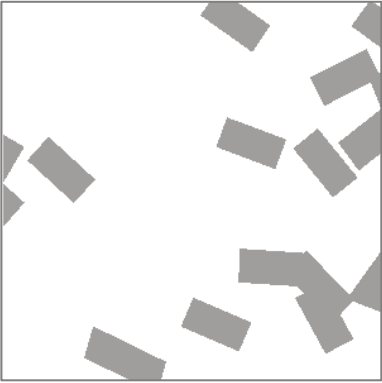
Cross-section	Defining parameters
<p>Cellulose</p>  	<p>Diameter 1 / (μm) Diameter 2 / (μm) Wall Thickness / (μm)</p>
<p>Rectangular</p>  	<p>Side Length 1 / (μm) Side Length 2 / (μm)</p>

FIBER PARAMETERS

The right column of the fiber type panel contains the parameters controlling the geometrical and physical properties of each fiber type in the paper structure.

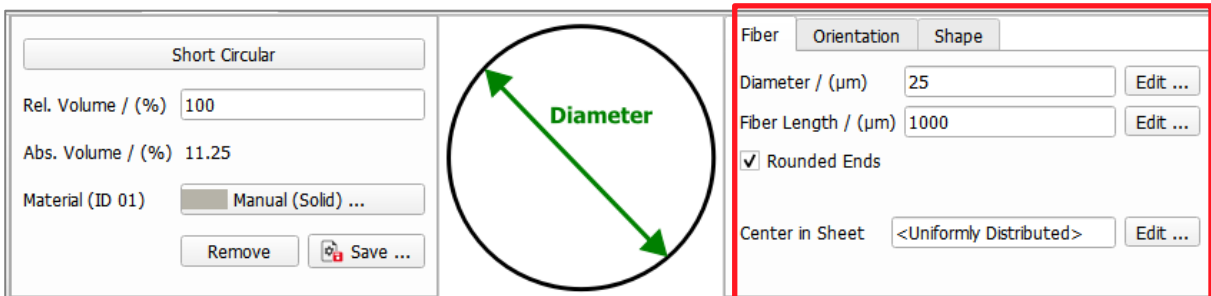

Some fiber parameters can only be set for some fiber types, such as the selections under the **Orientation** tab, the **Shape** tab, or the **Torsion** tab for Elliptical, Cellulose, Rectangular, or Angular cross-section fibers. The fiber length can only be set for **Short** fibers but not for **Infinite** fibers.

Many defining fiber parameters, which can be set to constant values or to follow a certain distribution, are organized under the **Fiber**, **Orientation**, and **Torsion** tabs:

Under the **Fiber** tab, the fiber **Diameter**, the **Fiber Length**, the **Wall Thickness**, and the **Side Length** can be set to a **Constant** value, or to follow a **Uniformly in interval** distribution, a **Gaussian** distribution, a user-defined **Probability Distribution**, or a **Log-Normal** distribution.

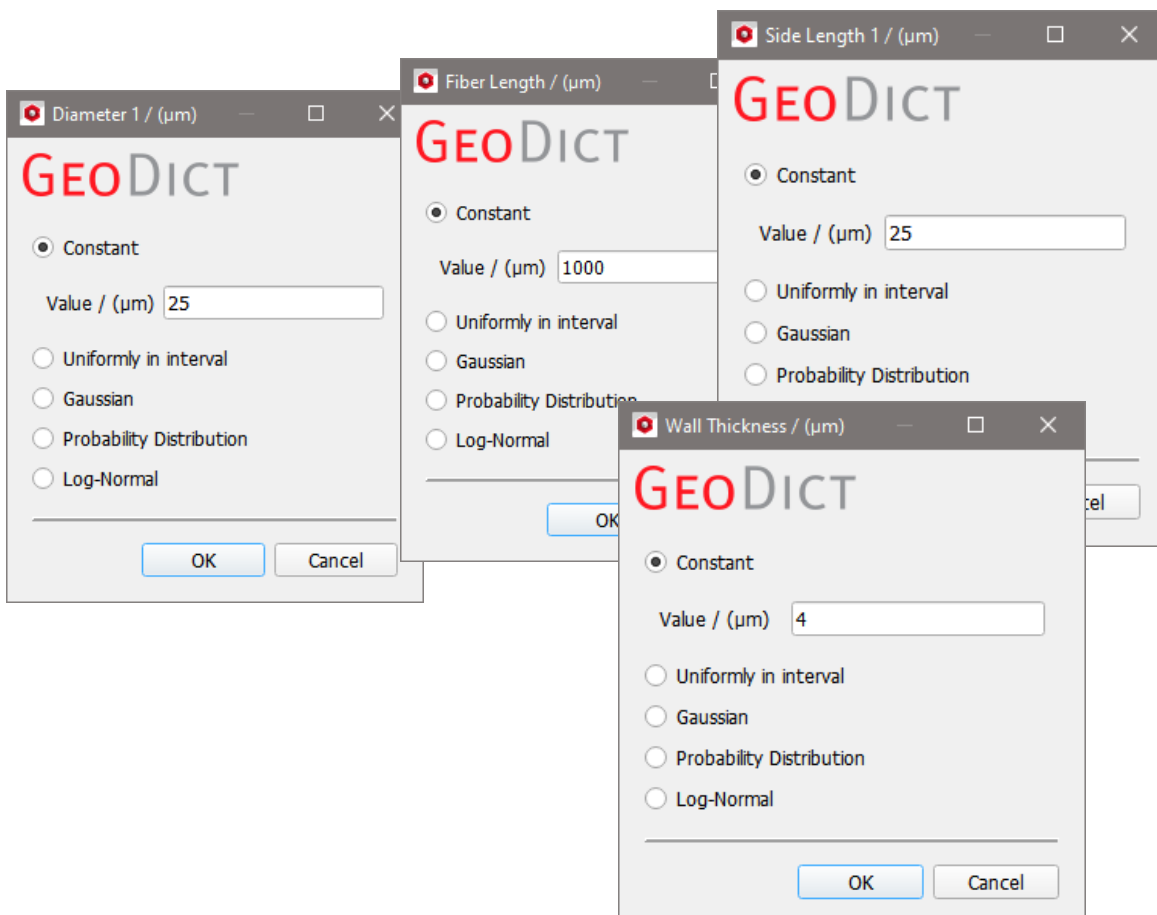

Also, under the **Fiber** tab, the **Center in Sheet**, for short and for infinite fibers, can be set to distribute **Uniformly** or to follow a user-defined **Density Distribution**. These distributions are explained in detail below (see [pages 32ff.](#)).

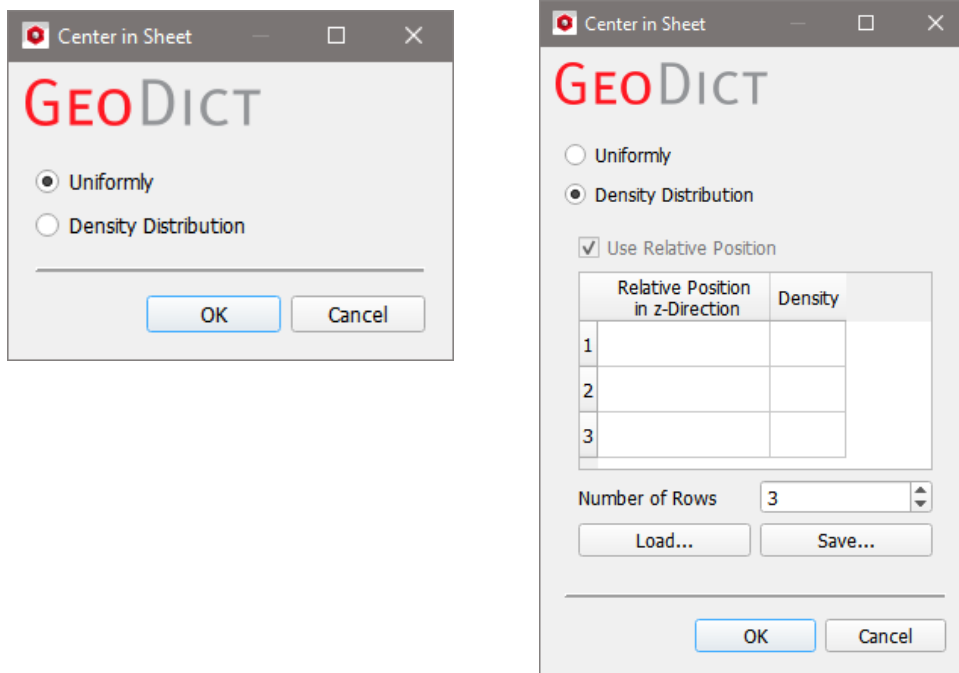

Under the **Orientation** tab, the **Rotation Angle** and the **Orientation Angle** values (for Orientation in Plane → Angle Distribution) can be set to be **Constant**, to follow a **Uniformly in interval** distribution, a **Gaussian** distribution, a user-defined **Probability Distribution**, or a **Log-Normal** distribution.

Except for Circular fibers, under the **Torsion** tab, the **Torsion Angle** value can be set to be **Constant**, to follow a **Uniformly in interval** distribution, or a user-defined **Probability Distribution**.

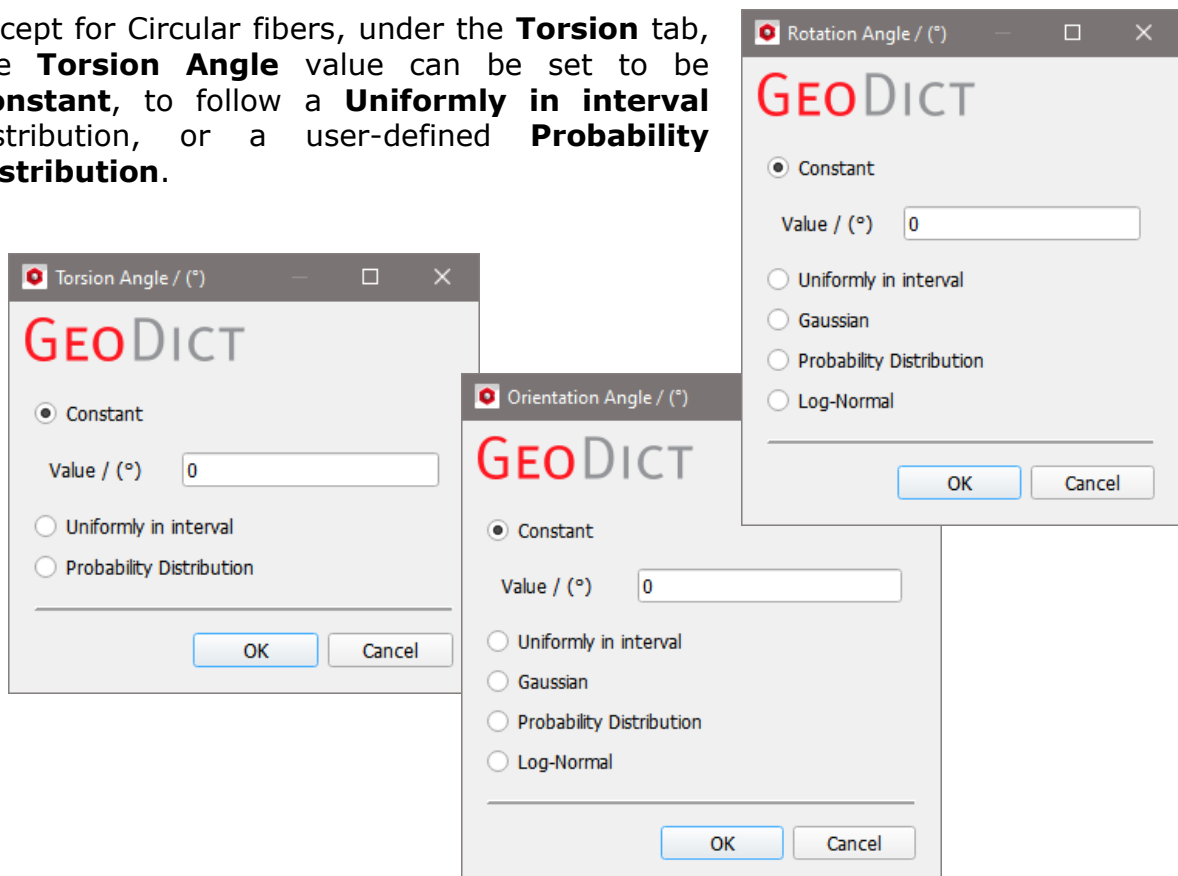

Constant and Uniformly in Interval

Observe the effect of choosing the diameter to be constant or to follow a uniform distribution in the following example with only infinite circular cross-section fibers. The generated structures are shown as 3D Rendering and as 2D cross-section. To better observe the circular cross-section in 2D view, the Anisotropy in Plane is set to 100.

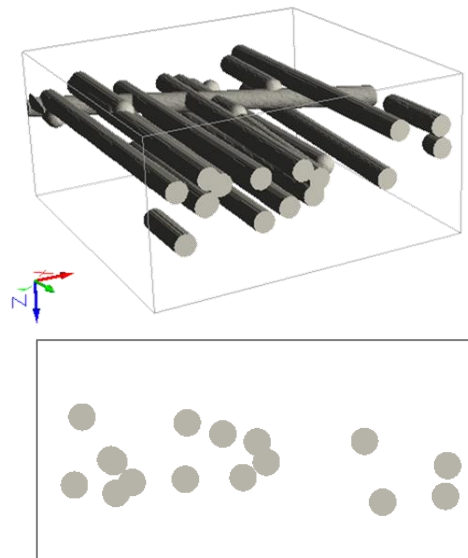
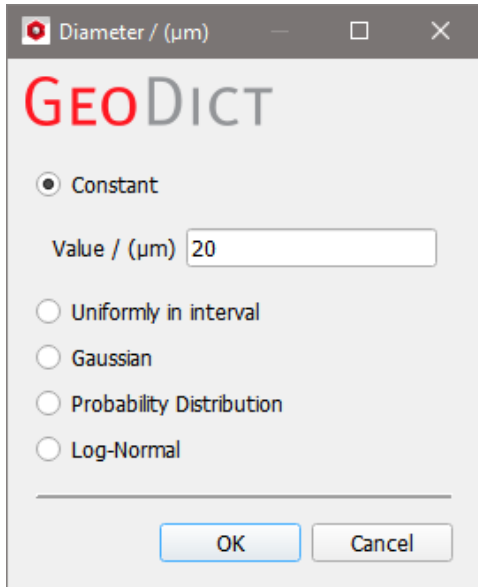

When selecting **Uniformly in interval**, and entering a **Minimum** value and a **Maximum** value, the random diameters are distributed within the given interval and every feasible diameter has the same probability.

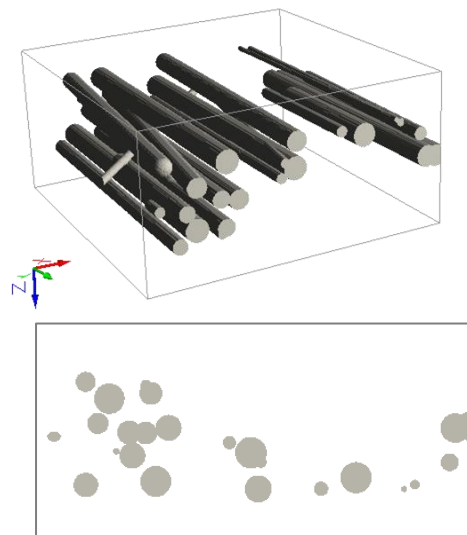
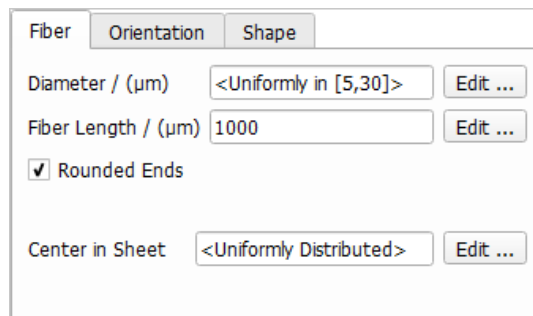
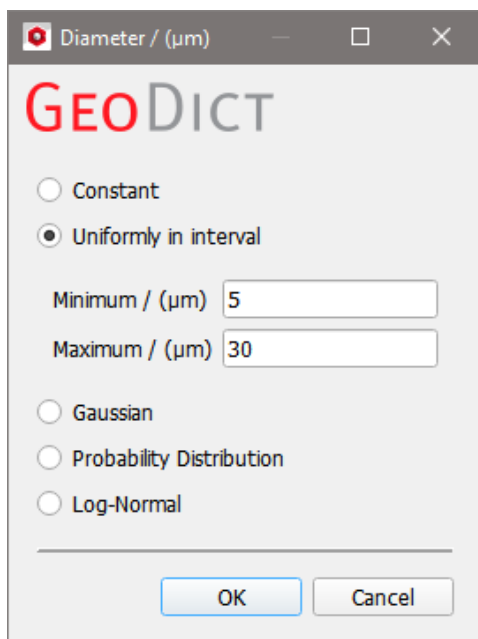

Gaussian

Taking the **Gaussian** distribution, the random diameter, length, or side length values follow a bell-shaped distribution. The values cluster around the entered **Mean Value** but may vary according to the entered **Standard Deviation**.

The value in **Distribution Bound** corresponds to the interval on both sides of the mean value limiting the random diameter or angle values that are accepted. For diameters, a **Distribution Bound** value of 10 μm means that the diameter values may vary only -10 μm to +10 μm from the given **Mean Value**.

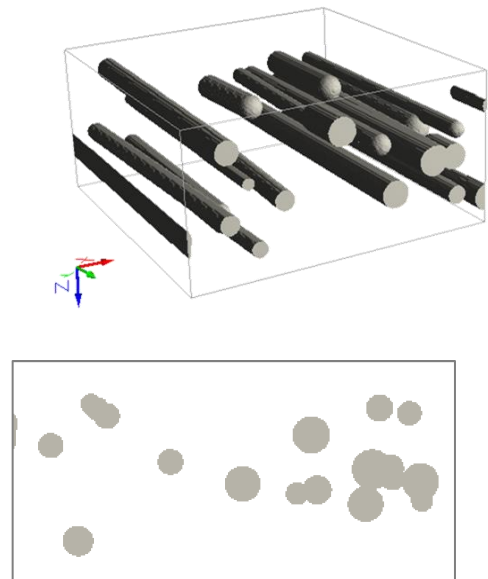
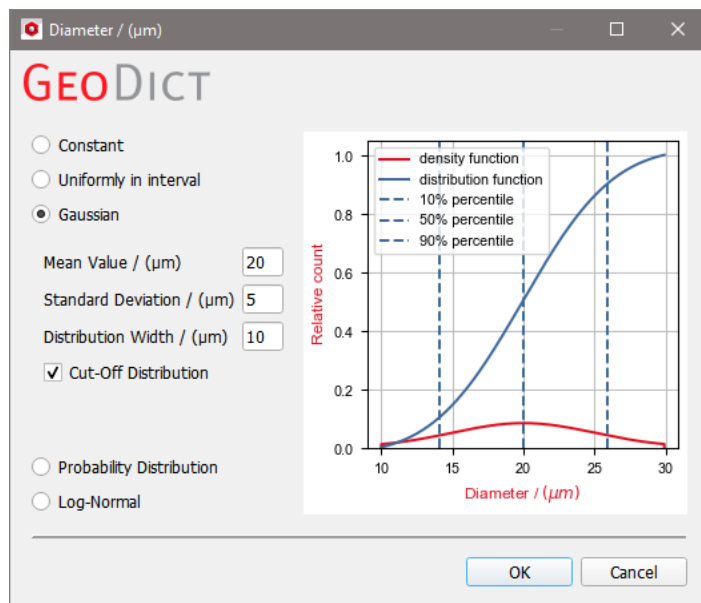

The parameters must be set so that no negative values are possible. For example, a diameter mean value of 20 μm and a distribution bound of 25 μm would lead to an error message appearing, as the diameter could reach a value less than zero.

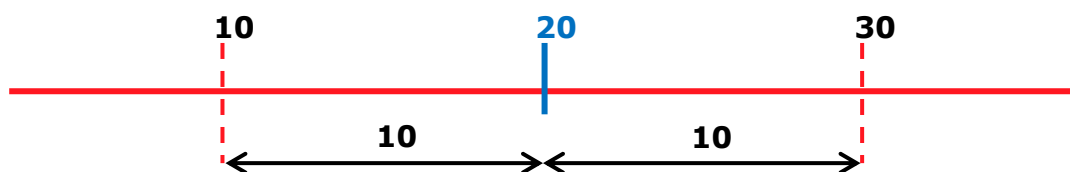

For all distribution options (Gaussian, Probability Distribution and Log-Normal) on the right of the dialog the distribution is visualized in a 2D plot.

The **red** line shows the **Diameter Percentage Distribution** defined by Mean Value, Standard Deviation and Distribution Width. It displays how many fibers of which diameter will be generated in percent. The **blue** curve shows the cumulative diameter distribution.

The three **dashed blue** lines show the diameter values for 10% percentile, 50% percentile and 90% percentile of the distribution. On average, 10% of the fibers have a diameter smaller than the 10% percentile value, and 90% of the generated fibers have a diameter higher than that value. For further explanations, see the [Wikipedia](#) article.

Right-clicking into the plot opens a dialog to **save** the plot or to **Edit** the **Axis Settings**. Checking or unchecking the checkboxes next to the graph names decides which curves should be displayed.

More information about these options can be found in the [Result Viewer handbook](#) of this User Guide.

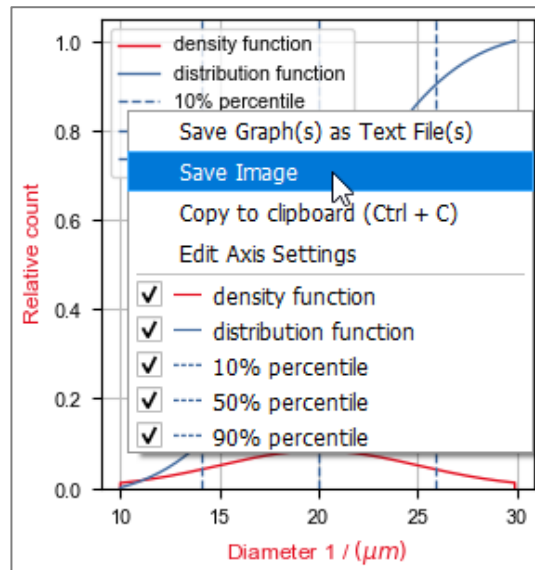

If **Cut-Off Distribution** is checked, the distribution is truncated at the bounds. This means, that all values outside the bounds are dropped and not considered for generation. If this option is not checked, then all values that are outside of the bounds are set to be on the distribution bound. Not checking this option would lead to an accumulation of values on the bounds.

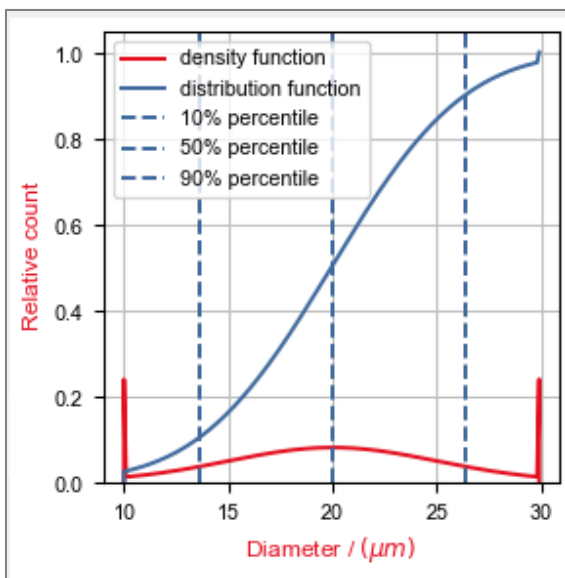

Cut-Off Distribution

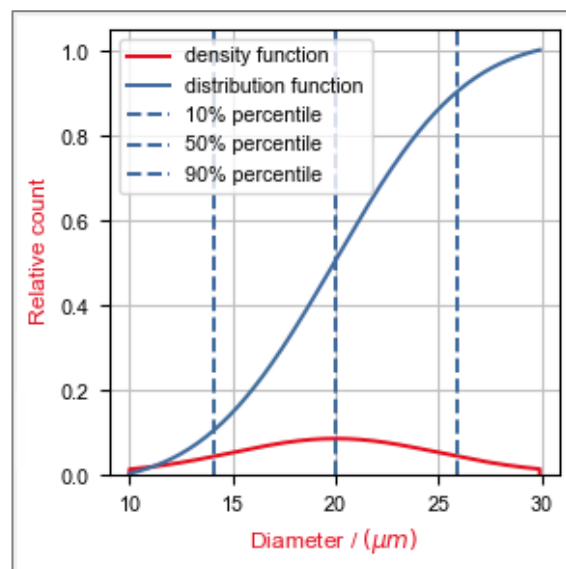

Cut-Off Distribution

In the following example, leaving **Cut-Off Distribution** unchecked leads to many fibers with diameters of 40 or 60 μm.

Gaussian
 Mean Value / (μm)
 Standard Deviation / (μm)
 Distribution Width / (μm)
 Cut-Off Distribution

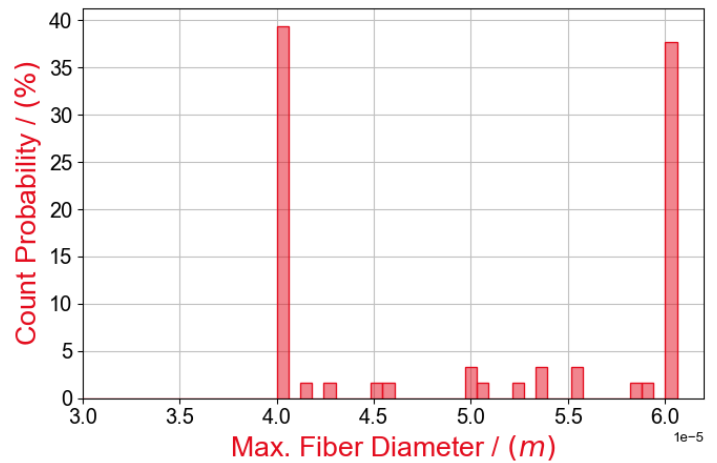
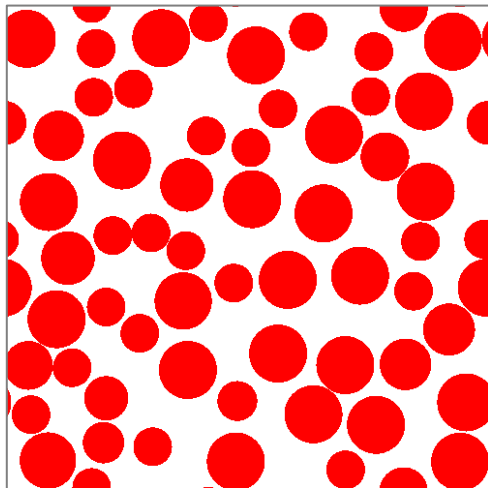

In contrast, checking **Cut-Off Distribution** leads to more grains with diameter of 50 μm .

Gaussian
 Mean Value / (μm)
 Standard Deviation / (μm)
 Distribution Width / (μm)
 Cut-Off Distribution

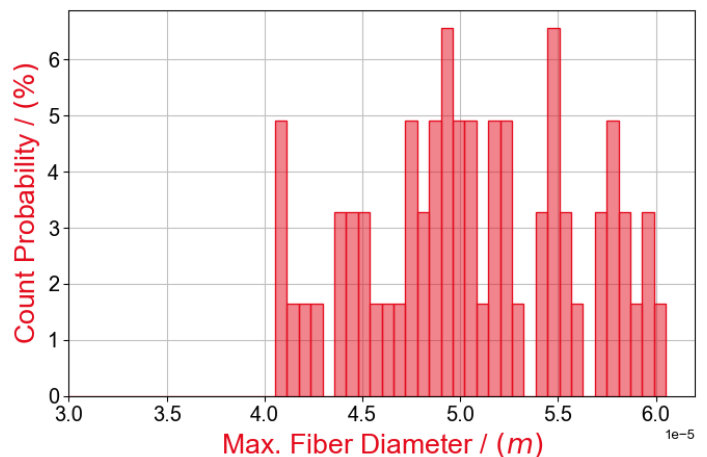
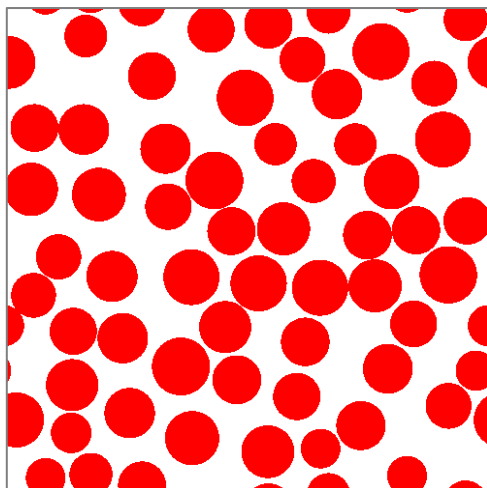

Further details on Gaussian distributions can be found e.g. on the [Wikipedia page on Normal \(or Gaussian\) distributions](#).

Probability Distribution

The **Probability Distribution** table enables for entering user-defined probability distributions. The **Number of Rows** can be increased or decreased to enter as many diameter, length, or angle **Values** and their **Count Probability**, between 0 and 1.

For large tables, it is useful to observe the value of **Probability Sum**, i.e. the sum of the count probabilities. When the **Probability Sum** is not equal to 1, click the **Normalize** button to automatically round the **Count Probability** values.

The buttons **Load** and **Save** allow loading a previous probability distribution and saving the current one for later use.

The screenshot shows the 'Diameter / (μm)' dialog box in GEO-DICT. The 'Probability Distribution' radio button is selected. A table contains the following data:

	Count Probability	Value / (μm)
1	0.5	20
2	0.2	40
3	0.3	15

The 'Probability Sum' is 1.0. The 'Number of Rows' is 3. The 'Normalize' button is visible. The graph shows a step-like distribution function and a density function with three peaks. The 3D visualization shows a bundle of fibers with varying diameters, and the 2D visualization shows a cross-section with circles of different sizes.

Log-Normal

The **Log-Normal** distribution describes the situation in which the logarithm of the diameter values follows a normal distribution.

The diameter values group around the entered **Arithmetic Mean Value** and scatter according to the entered **Arithmetic Standard Deviation**. The values in **Lower Bound** and **Upper Bound** restrict the possible values that the random diameters can take to the given interval.

The screenshot shows the 'Diameter / (μm)' dialog box in GEO-DICT with the 'Log-Normal' radio button selected. The input fields are:

- Arithmetic Mean Value / (μm): 35
- Arithmetic Standard Deviation / (μm): 8
- Lower Bound / (μm): 5
- Upper Bound / (μm): 10

The 'Cut-Off Distribution' checkbox is checked. The graph shows a smooth, right-skewed density function and a corresponding distribution function. The 3D and 2D visualizations show a fiber bundle and its cross-section, respectively, with diameters concentrated between 5 and 10 μm.

Fiber

Diameter and Wall Thickness

A circular fiber has only one diameter value. The **Diameter** value can be edited by clicking the **Edit...** button to open the **Diameter** dialog box. The circular fiber diameter can be set to have a **Constant** value, or to follow a diameter distribution (**Uniformly in interval**, **Gaussian**, **Probability Distribution**, or **Logarithmic-Normal**) as indicated above started in page [27ff](#).

For non-circular fibers, such as elliptical and cellulose fibers, two diameter values (**Diameter 1** and **Diameter 2**) need to be entered.

For cellulose fibers, the **Wall Thickness** must also be defined.

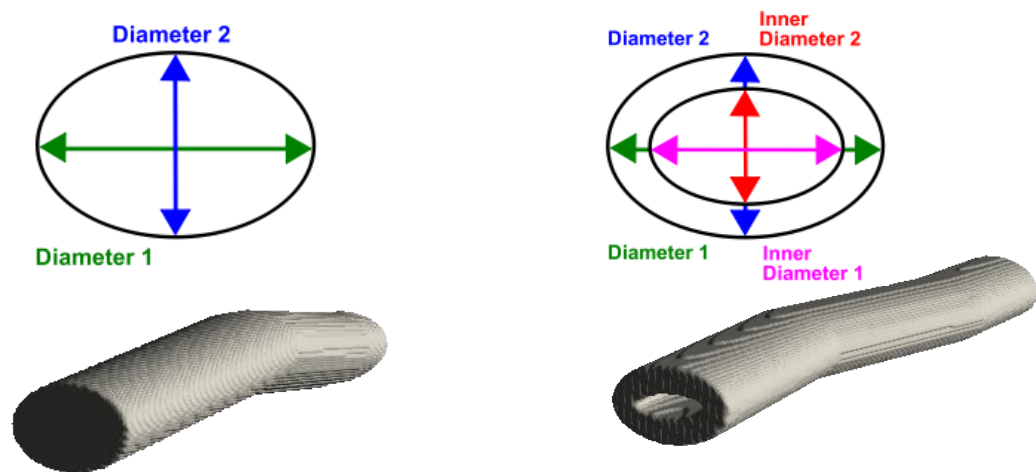

Fiber Length and Side Length

Fibers can be **Short** or have **Infinite** length. The length of short fibers is editable by clicking on the **Edit...** button and choosing the desired settings in the **Fiber Length (μm)** dialog box.

The **Fiber Length**, and also the **Side Length** for Short Rectangular fibers, can be set to take a **Constant** value, or to follow a distribution (**Uniformly in interval**, **Gaussian**, **Probability Distribution**, or **Log-Normal**).

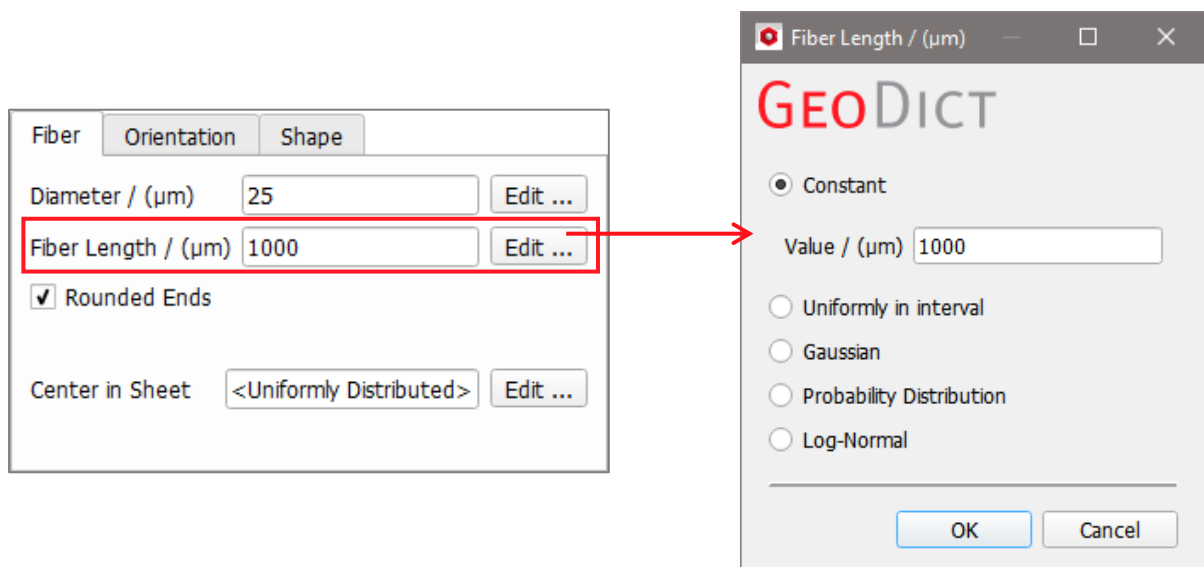

Fiber	Orientation	Shape	Torsion
Side Length 1 / (μm)	25	Edit ...	
Side Length 2 / (μm)	10	Edit ...	
Fiber Length / (μm)	1000	Edit ...	
<input checked="" type="checkbox"/> Rounded Ends			
Center in Sheet	<Uniformly Distributed>	Edit ...	

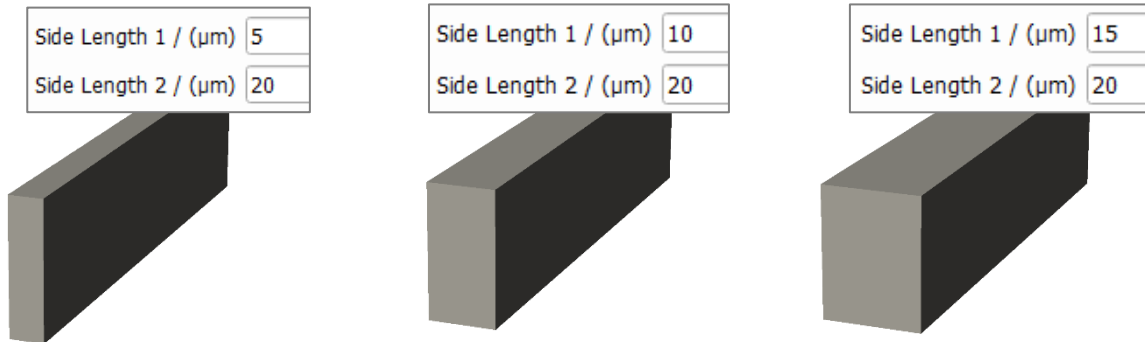
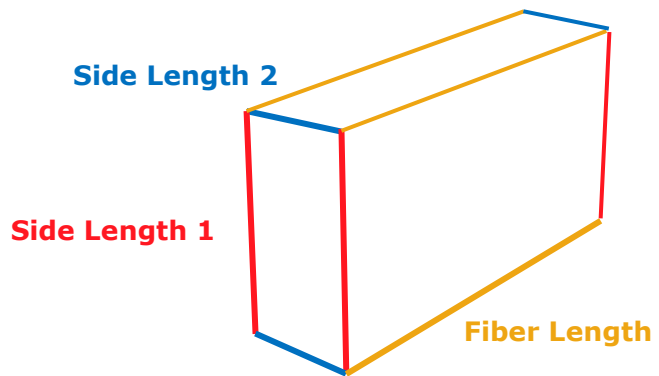

Rounded Ends

Short fibers with any cross-section (Circular, Cellulose, Elliptic, or Rectangular) can be created with or without rounded ends by checking or leaving un-checked the **Rounded Endings** box. Observe the variation in the shape of the short rectangular fibers after checking the **Rounded Endings** box.

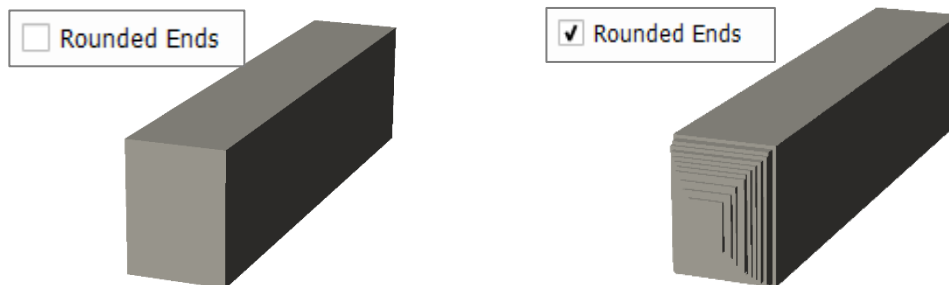

Center in Sheet

The position of the fiber centers in Z-direction can be set to be **Uniformly** distributed in the sheet of paper or to follow a user-defined **Density Distribution**. This option is available for all fiber types. The values for **Center in Sheet** define the relative position in Z-direction of the fibers in relation to the given [Sheet Thickness](#) (which can be defined in the Create Options tab).

In the following example, a paper with two types of fibers is generated. The grey fibers are Short Cellulose fibers with centers following a user-defined density distribution. The yellow fibers are Short Circular fibers with centers uniformly distributed in the paper sheet.

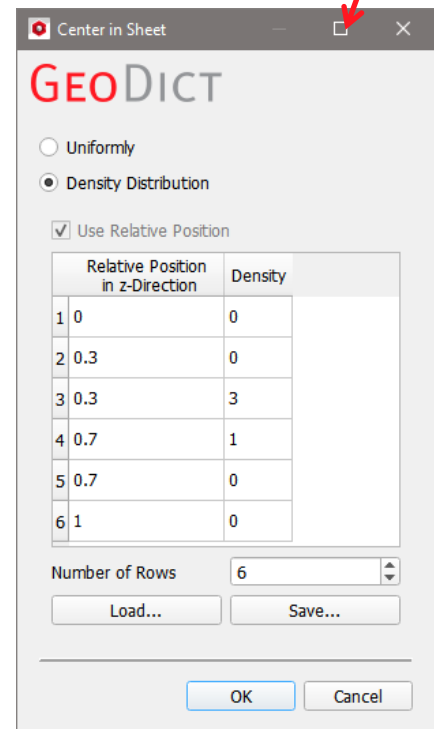
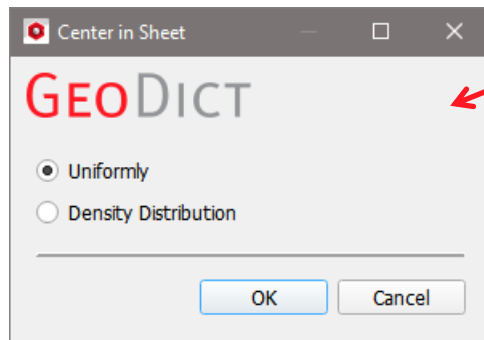
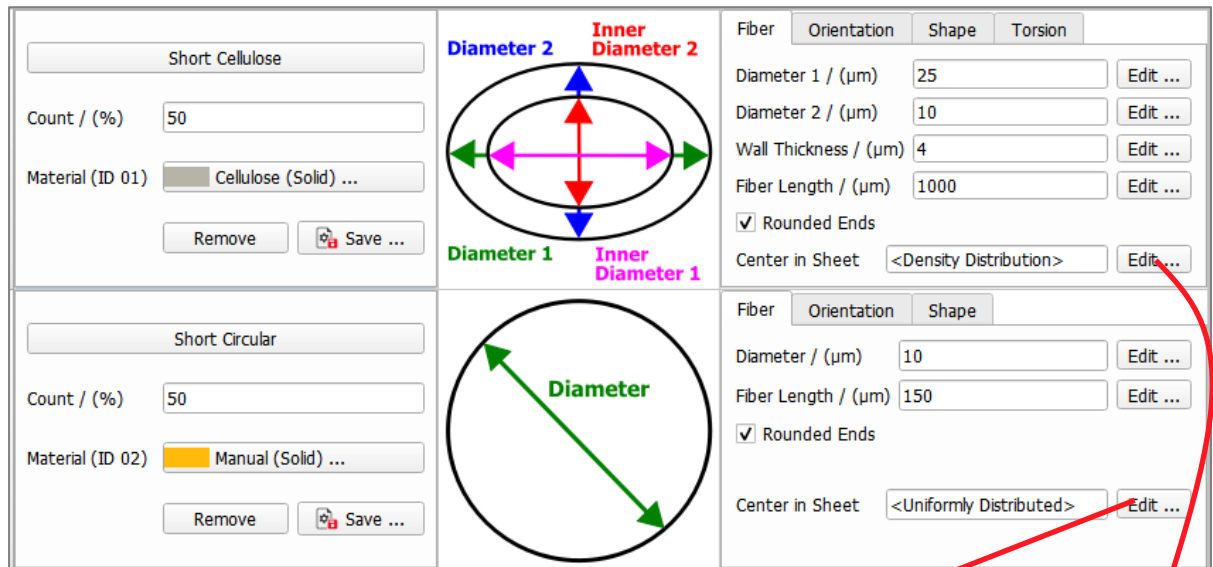

In the density distribution table, the left column values from 0 to 1 correspond to locations in the structure. In the Z-direction, the value 0 is the bottom and the value 1 is the top of the sheet. The right column assigns relative density values at these locations. The value **3** at $Z = 0.3$ means that the probability for a fiber center to be located at $Z = 0.3$ is three times higher than at $Z = 0.7$, where the density value is **1**. The fiber density increases and decreases linearly between the given locations in the Z-direction.

Observe how, with the values in this table, the grey fibers occupy the area in the middle of the paper sheet ($Z=0.3$ to $Z=0.7$), whereas the yellow fibers' centers are distributed uniformly in it.

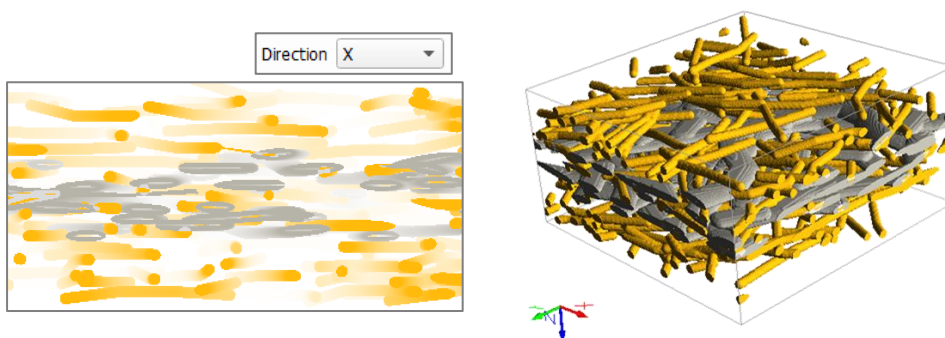

Orientation

Orientation in Plane: Anisotropy and Angle Distribution

Two possible orientations of the fibers in the XY-plane can be selected from the pull-down menu: **Anisotropy** or **Angle Distribution**. Refer to the [FiberGeo handbook](#) for a detailed explanation of anisotropy and fiber orientation in the structure's geometry.

After selecting **Anisotropy**, the desired **Anisotropy in Plane** value can be entered. A value of 1 for **Anisotropy in Plane** corresponds to the isotropic case. In the following examples, all other parameters are left unchanged while the value of the **Anisotropy in Plane** is modified as indicated.

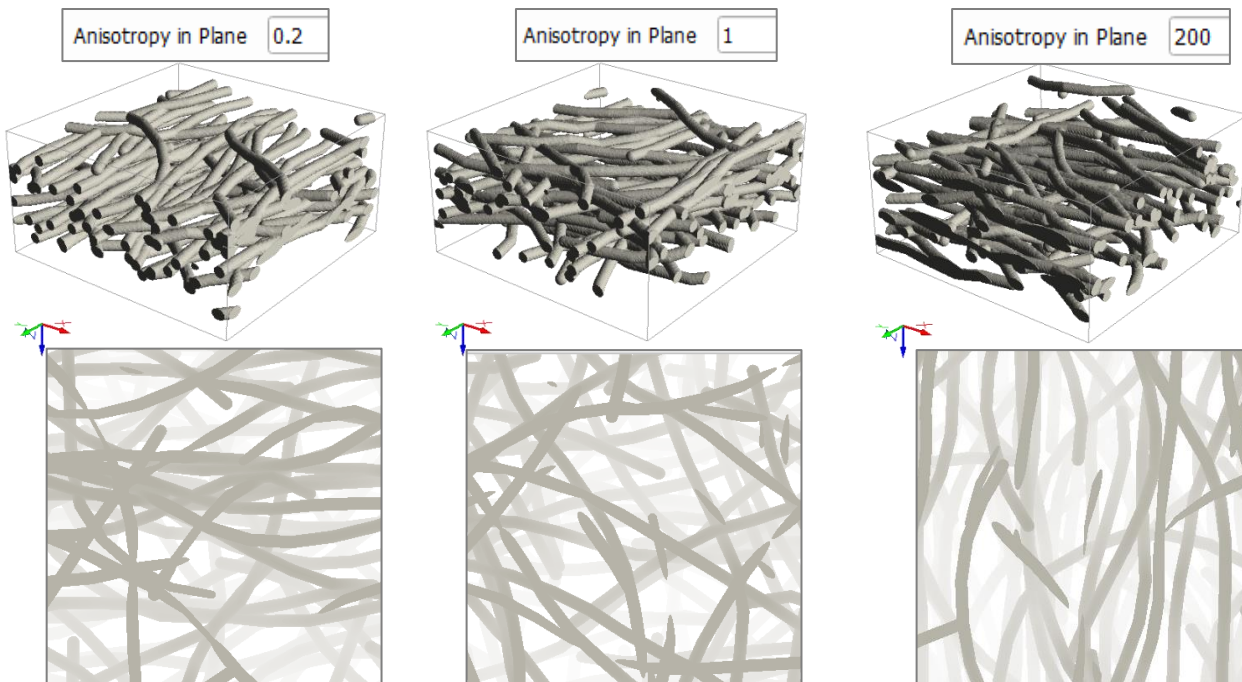
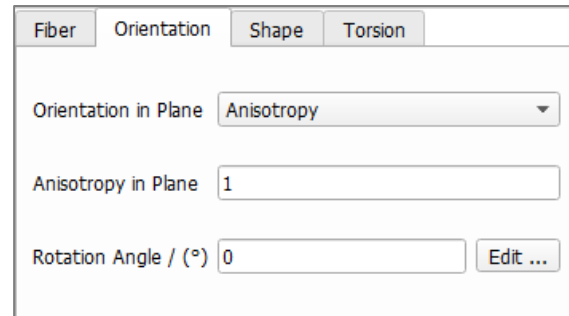
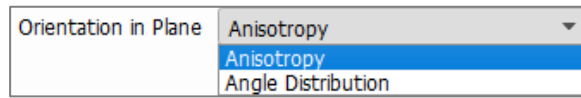

It is possible to create paper structures with different fiber types which additionally have different values for their **Anisotropy in Plane**. The following paper structure (500x500x200) of grammage 20 g/m² was created using 70% of 200 μm long yellow cellulose fibers (25 μm x 10 μm, wall thickness 4) μm with anisotropy in plane of 200, and 30% of 100 μm long grey ellipsoidal fibers (8 μm x 2 μm) with anisotropy in plane of 1.

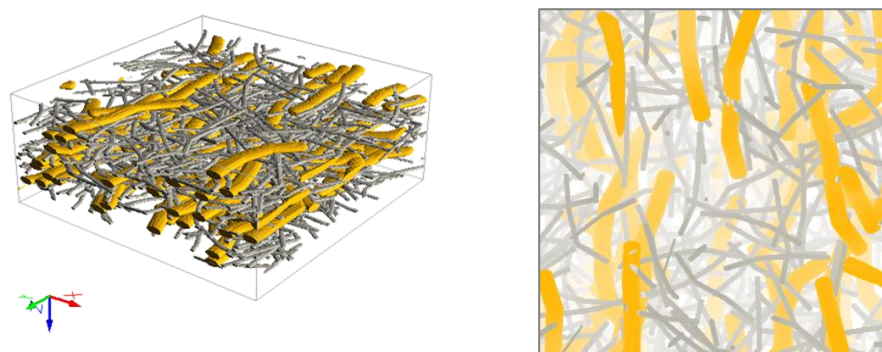

After selecting **Angle Distribution** from the **Orientation in Plane** pull-down menu, the desired **Orientation Angle** of the fibers in the XY plane can be directly set to a constant value or to follow a distribution through the **Edit...** button.

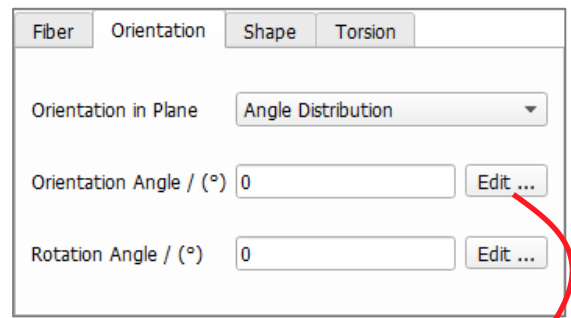

When the **Orientation Angle / (°)** dialog opens, select a **Constant** angle or one of the available angle distributions (**Uniformly in interval**, **Gaussian**, **Probability Distribution**, or **Log-Normal**), as explained in pages 26ff. for diameter distributions. The desired values controlling these distributions can be entered in the corresponding boxes.

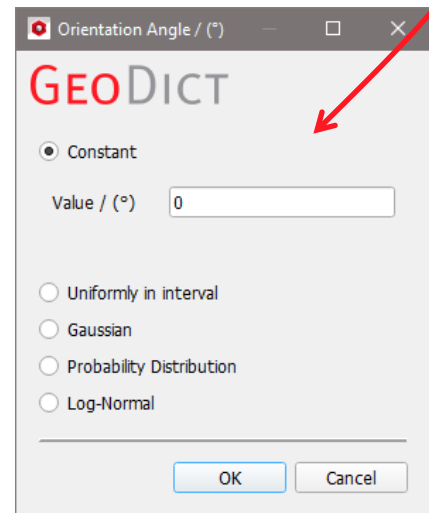

In the following examples, all parameters of the randomly curved circular fibers are left unchanged while the value of the **Orientation Angle** is modified as indicated.

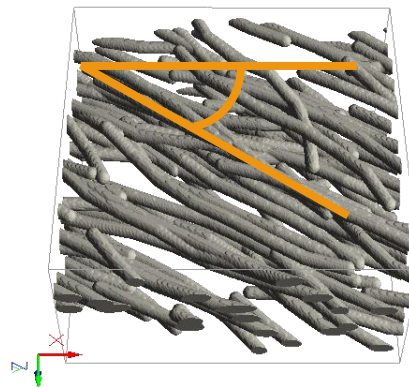
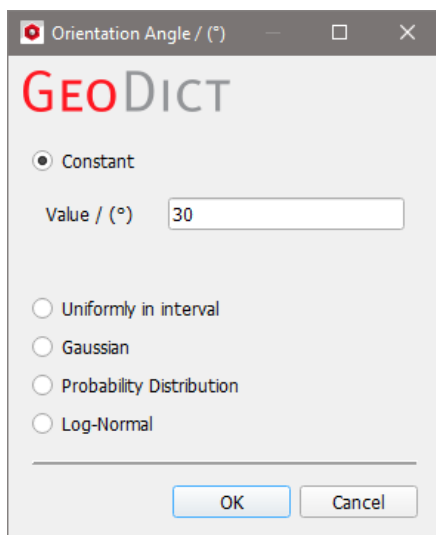

Fibers have an orientation between 45° and 135°

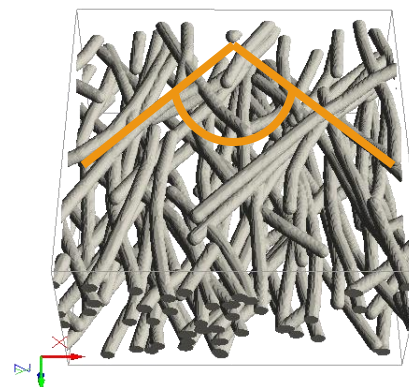
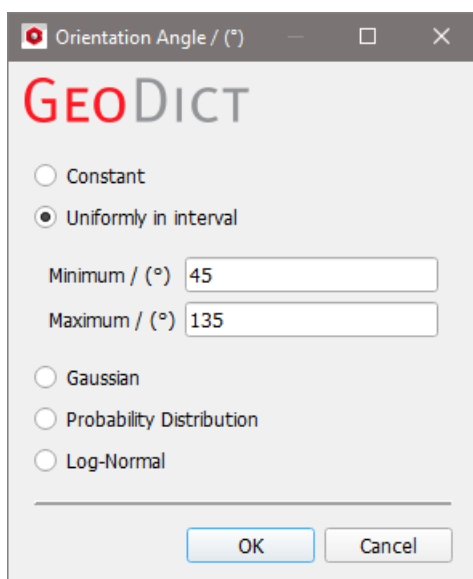

Fibers are normally distributed around the mean value 45° with a standard deviation of 10° .

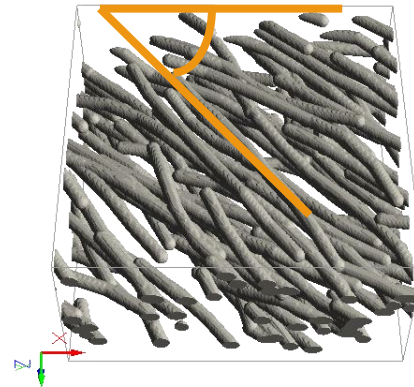
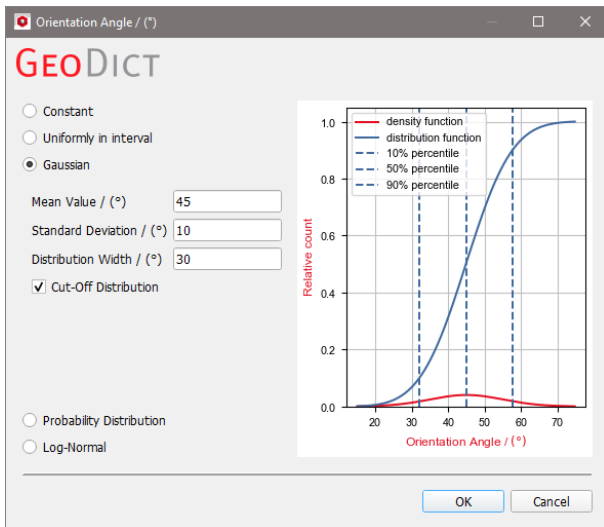

The majority of fibers (60%) have an orientation of 0° to the XY-plane, 20% have a 90° orientation and another 20% have a 45° orientation.

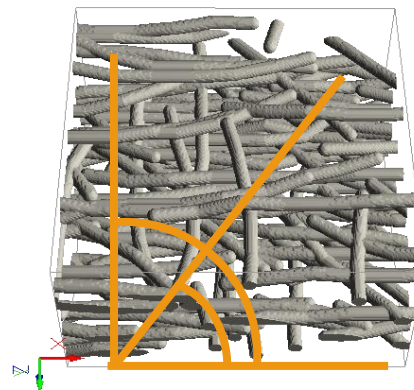
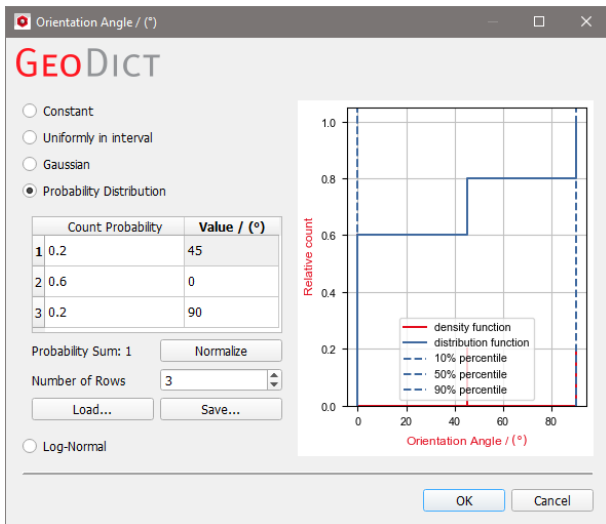

The fiber orientation angle values are log-normally distributed with a mean value of 15° and a standard deviation of 5° . The **Lower Bound** (1°) and **Upper Bound** (9°) values restrict the possible values that the random diameters can take to the interval between them.

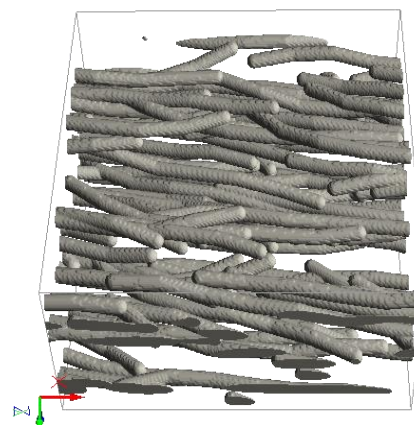
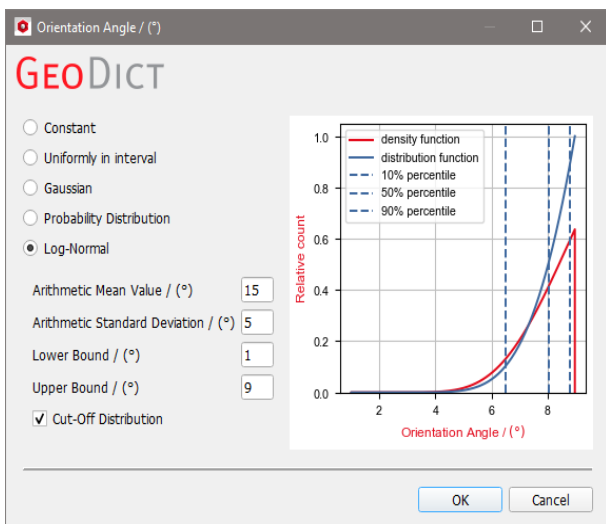

The **Rotation Angle** is a measure of the angle the fiber profile has to the XY-plane (i.e. a measure for the rotation of the cross-section). This parameter has no effect if the fibers are circular and straight.

The rotation angle can be set to take a **Constant** value or random values, (**Uniformly in interval**, **Gaussian Probability Distribution**, or **Log-Normal**). The desired values for these distributions can be entered in the opening boxes, as explained above (pages 26ff.).

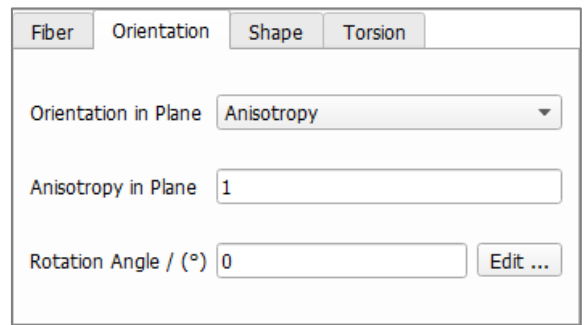

In the following example, all parameters are left unchanged (including Random Seed) while the **Rotation Angle** of the elliptical straight fibers is set as indicated. The generated structures are shown in 3D Rendering and in 2D Cross-section. The choice of **Anisotropy in Plane** leads to positively and negatively oriented fibers, so that they appear tilted with +45° and -45°.

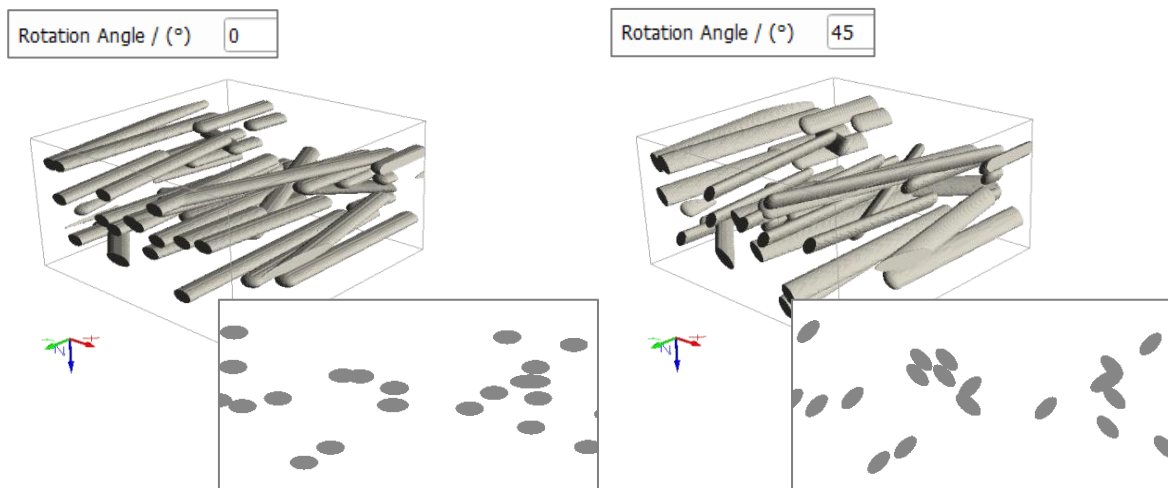

Shape

Shape Mode: Randomly Curved Fiber, Sine Fiber, and Straight Fiber

The **Shape Mode** pull-down menu lists the options to define the longitudinal shape of the fibers: **Randomly Curved Fiber**, **Sine Fiber**, and **Straight Fiber**.

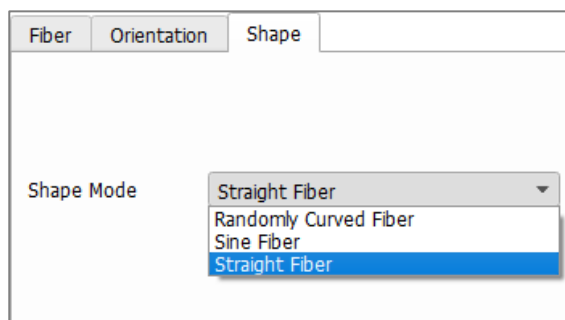

A **Straight Fiber** is straight by definition, so no additional shape parameters are available. To create straight fibers with **Torsion**, choose randomly curved fibers with zero **Randomness in Plane** and zero **Randomness Perpendicular** (see pages 38ff.).

Segment Length

For randomly curved and sine fibers, the **Segment Length** determines the length of the linear parts that build the fiber (finer segments), so that small values lead to well resolved fibers with smooth curving.

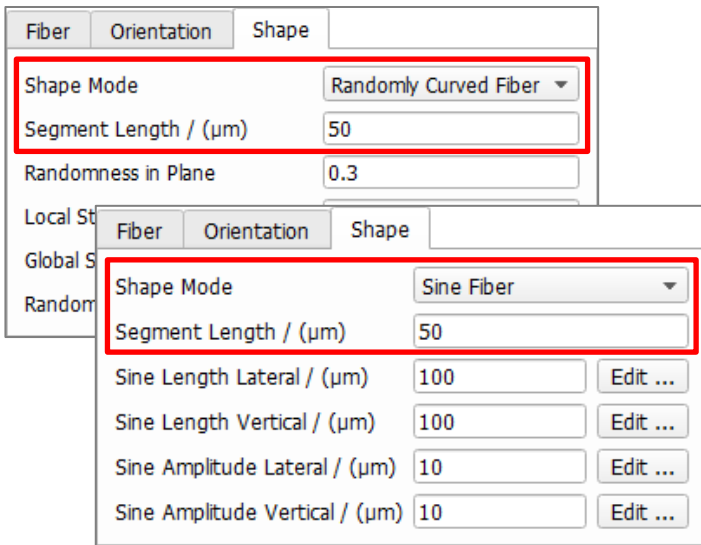

A smaller segment length leads to longer computation times when using **Lay-Down fibers**. A large segment length leads to fibers with long straight segments.

In the following examples, all parameters are left unchanged while the short circular, randomly curved fibers with a length of 1000 µm are given varying **Segment Lengths**, as indicated.

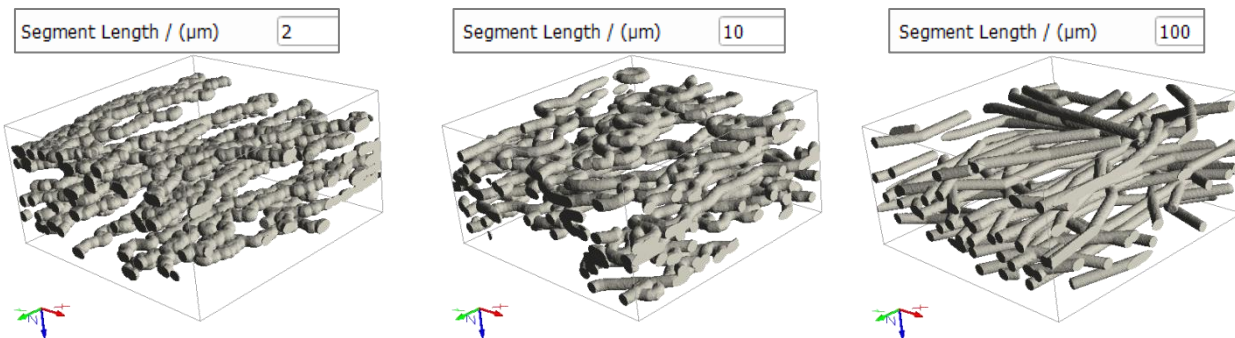

Randomness in Plane, Local Straightness in Plane, Global Straightness in Plane, Randomness Perpendicular

Randomly Curved Fibers follow a random curve determined by **Randomness in Plane**, **Local Straightness in Plane**, **Global Straightness in Plane**, and **Randomness Perpendicular**.

The values of these parameters are between 0 and 1 and describe how strongly a fiber may change direction from one segment to the next. The different parameters complement each other, whereby the straightness parameters control the amount of curvature locally or globally and the randomness parameters define the amount of random influences.

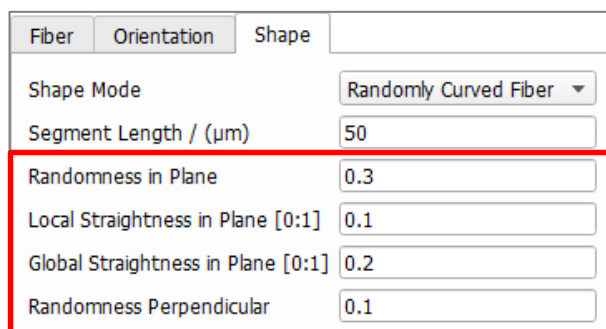

The following examples show the effect of these parameters for short elliptical or circular **Randomly Curved Fibers**. The segment length is set to 20 μm for both types of fibers.

Initially, the **Randomness in Plane** is set to 0, as are all other three randomness parameters. Then, the **Randomness in Plane** is set to 0.1 and finally to 0.2. Too large values of **Randomness in Plane** lead to unrealistic results in this constellation.

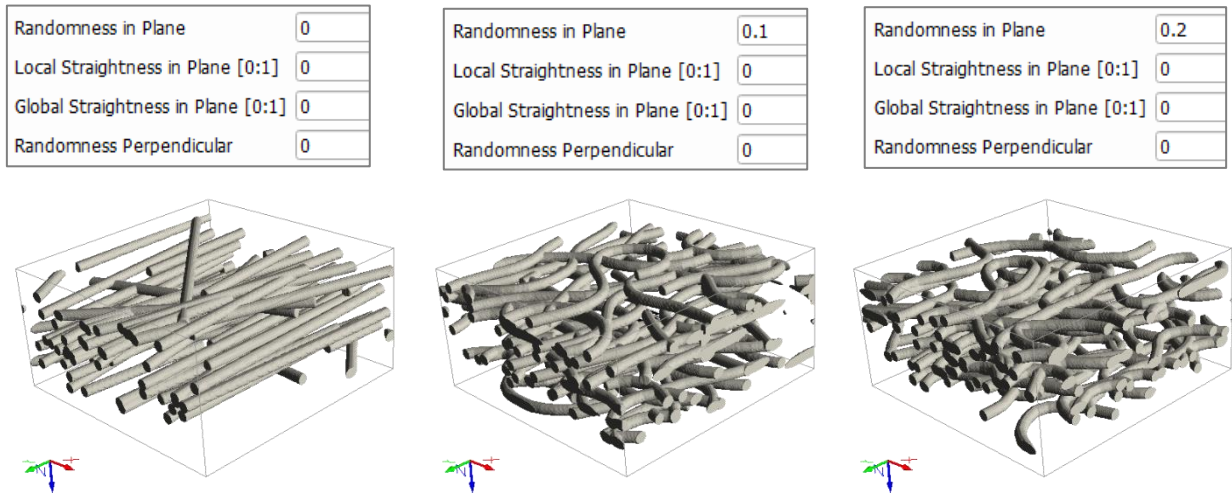

Observe that using **Randomness in Plane**, the deformation occurs only in the XY-plane and not in the Z-direction.

To achieve a deformation in the Z-direction, **Randomness Perpendicular** must be used. A structure created with a higher Randomness Perpendicular value (0.2) is viewed in 3D Rendering and in 2D Cross-section to show that the deformation occurs in the Z-direction while no deformation can be observed in the XY-plane.

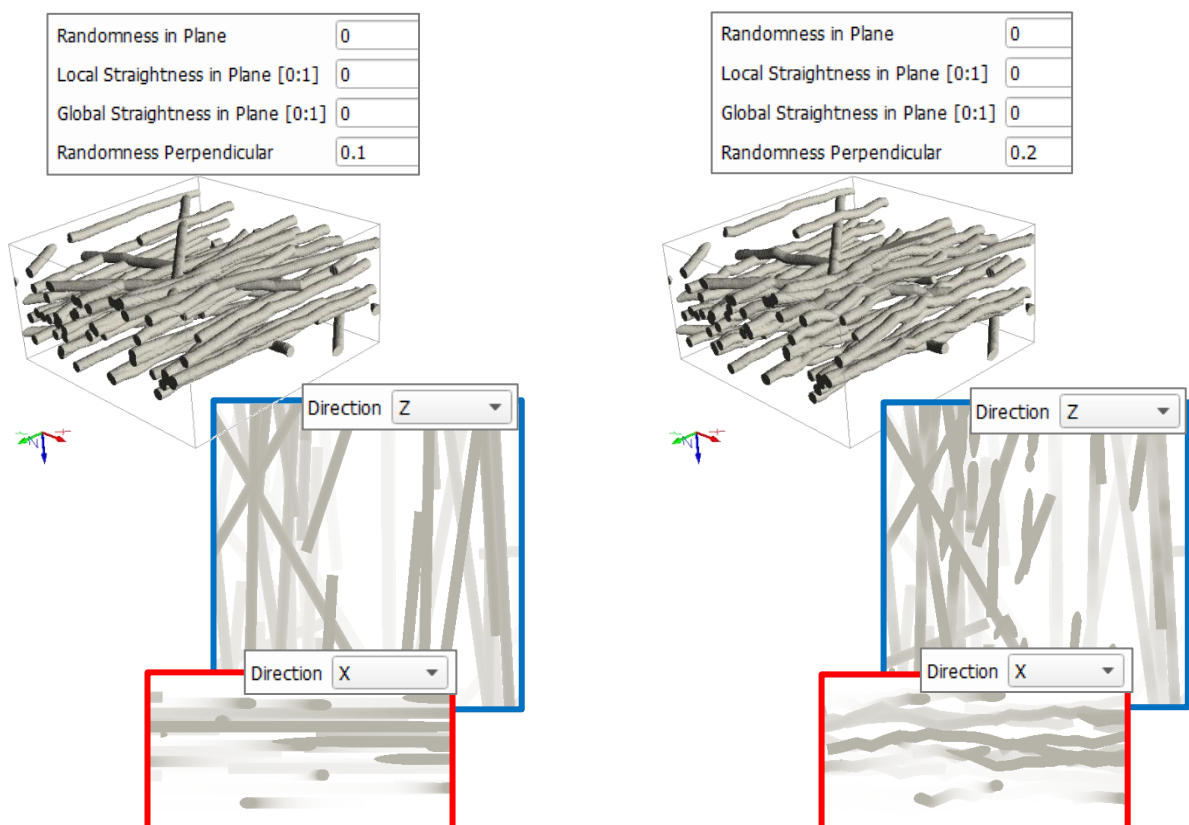

The **Local Straightness in Plane** parameter controls how strongly fibers might change direction from one segment to the next. Observe the effect of increasing the **Local Straightness in Plane** from 0 over 0.5 to 1, while the Randomness in Plane is kept at a constant value of 0.2. The segment length is 20 μm . The fibers appear locally straighter but are globally curved.

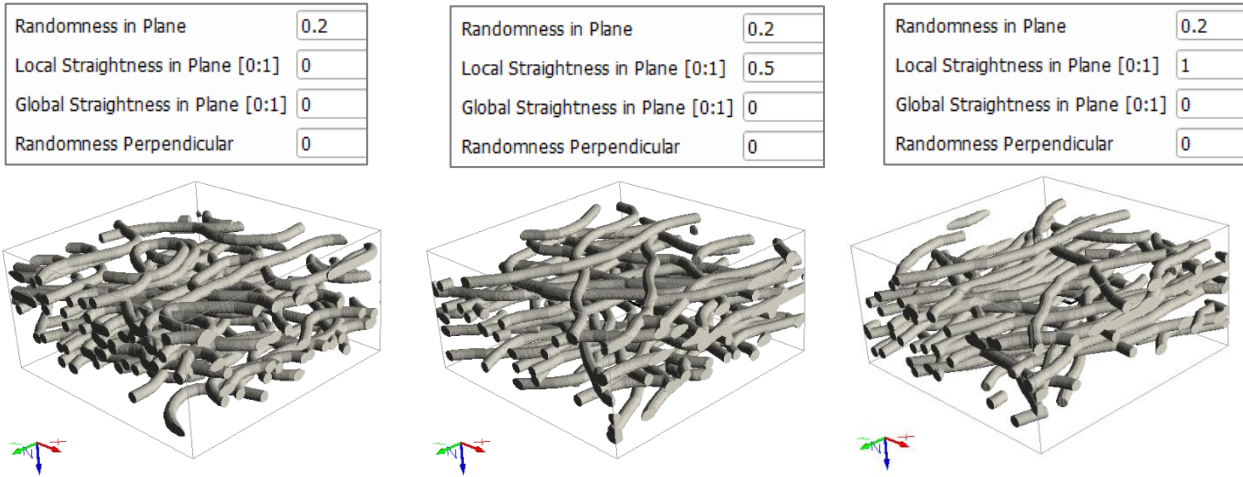

The **Global Straightness in Plane** parameter controls how strongly the fibers follow their main fiber direction. Observe the effect of increasing values of **Global Straightness in Plane** (0, 0.1, and 1), while the Randomness in Plane is kept at a constant value of 0.2. The segment length is 20 μm . The fibers appear globally straighter, while they are still locally curved.

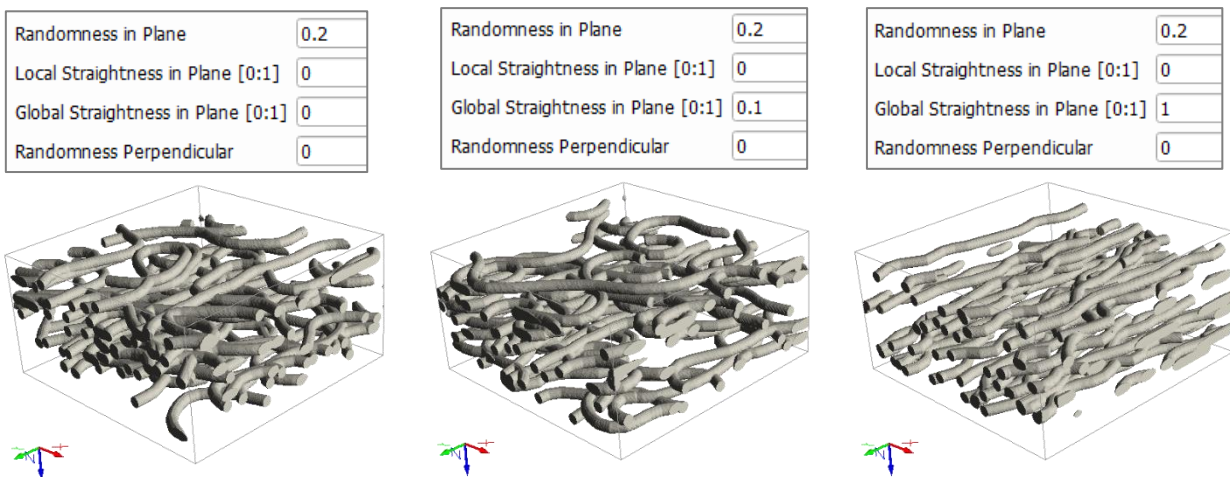

For a more detailed explanation how the parameters influence the curvature, refer to the [FiberGeo handbook](#).

Sine Length Lateral and Vertical, Sine Amplitude Lateral and Vertical

Sine (or sinusoidal curved) **Fibers** are following a sinusoidal curve where the length and amplitude parameters can be defined in two perpendicular directions.

Sine Length
Sine Amplitude



The direction of the parameters **Sine Length Lateral**, **Sine Length Vertical**, **Sine Amplitude Lateral**, and **Sine Amplitude Vertical** is depending on the fiber orientation.

For elliptical fibers, lateral and vertical describe the directions of the main axes.

Fiber	Orientation	Shape
Shape Mode	Sine Fiber	
Segment Length / (μm)	50	
Sine Length Lateral / (μm)	100	Edit ...
Sine Length Vertical / (μm)	100	Edit ...
Sine Amplitude Lateral / (μm)	10	Edit ...
Sine Amplitude Vertical / (μm)	10	Edit ...

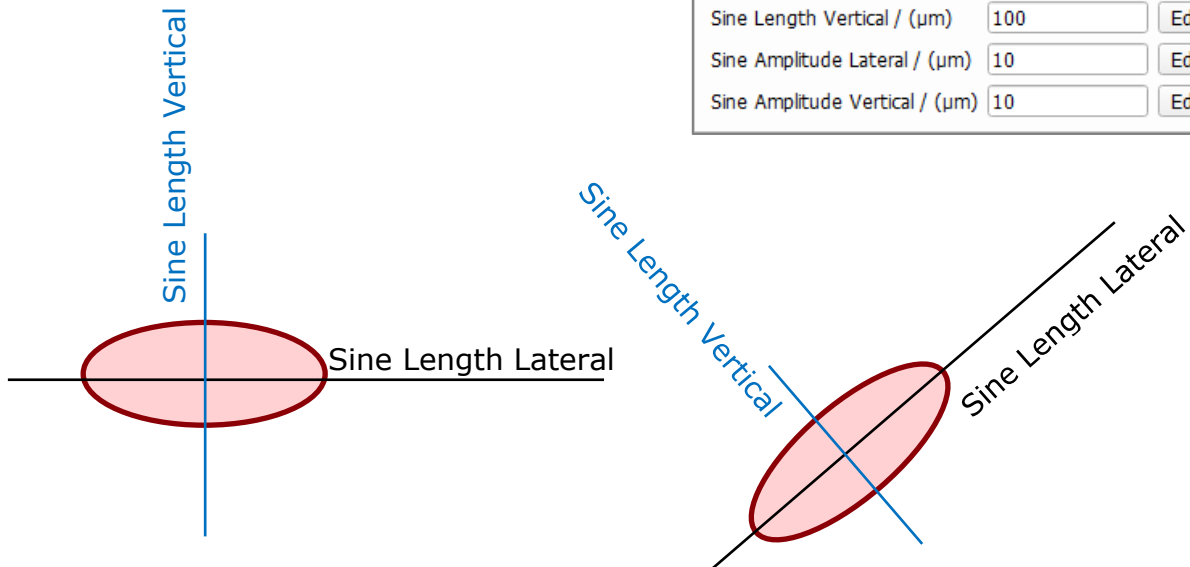

The following examples show the influence of these parameters on sine fibers. The Segment Length is set to $25 \mu\text{m}$ ($\frac{1}{4}$ of the sine length).

Initially, **Sine Amplitude Lateral** and **Sine Amplitude Vertical** are set to 0 (as are the **Rotation Angle** and the **Torsion Angle**) to produce fibers that are straight. To better observe this effect, the Anisotropy in Plane has been set to 20.

Sine fibers have only a vertical component when the **Sine Amplitude Vertical** takes a value greater than zero, while the **Sine Amplitude Lateral** is $0 \mu\text{m}$. Vice versa, they have only a lateral component when the **Sine Amplitude Vertical** is $0 \mu\text{m}$ and the **Sine Amplitude Lateral** is larger than zero.

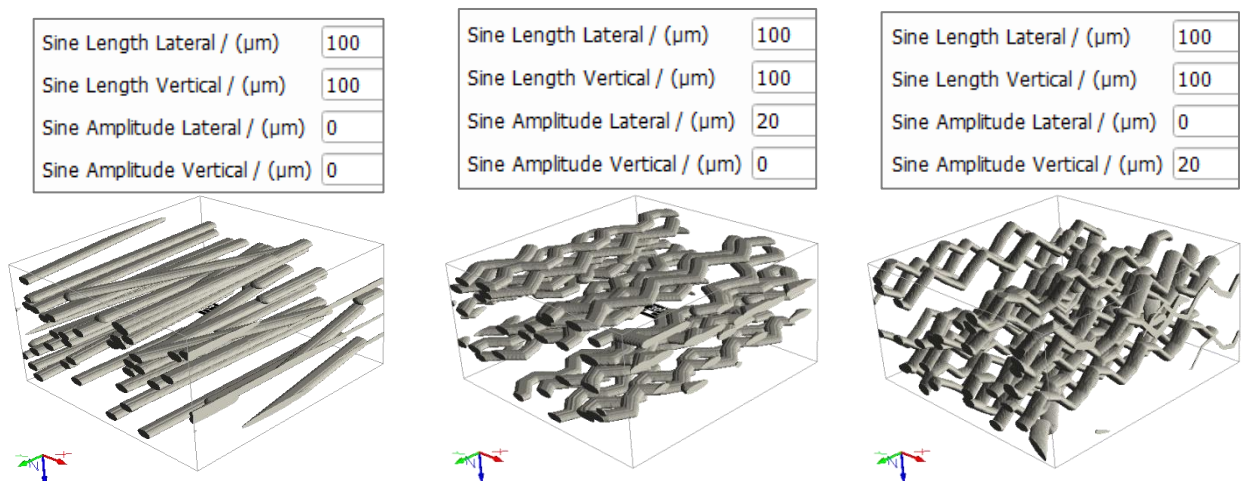

Sine fibers with a combination of lateral and vertical components are obtained, for example, with the following values:

Fiber	Orientation	Shape		
Shape Mode	Sine Fiber			
Segment Length / (μm)	25			
Sine Length Lateral / (μm)	150	Edit ...		
Sine Length Vertical / (μm)	250	Edit ...		
Sine Amplitude Lateral / (μm)	15	Edit ...		
Sine Amplitude Vertical / (μm)	25	Edit ...		

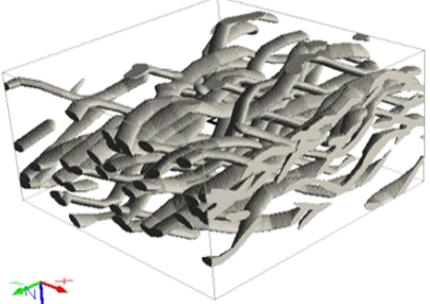

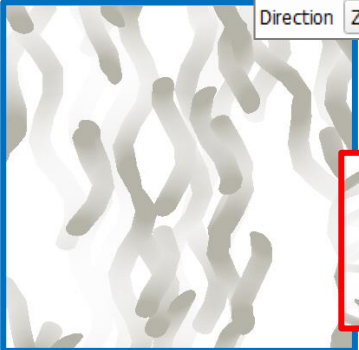

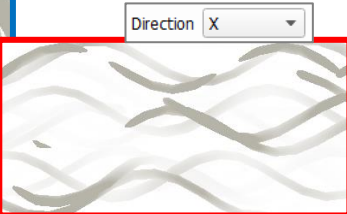

Setting higher values of **Sine Length Lateral** and **Sine Length Vertical** produces less sharply bent sine fibers. Segment Length is kept at 25 μm .

Sine Length Lateral / (μm)	100	Sine Length Lateral / (μm)	200	Sine Length Lateral / (μm)	400
Sine Length Vertical / (μm)	100	Sine Length Vertical / (μm)	200	Sine Length Vertical / (μm)	400
Sine Amplitude Lateral / (μm)	0	Sine Amplitude Lateral / (μm)	0	Sine Amplitude Lateral / (μm)	0
Sine Amplitude Vertical / (μm)	20	Sine Amplitude Vertical / (μm)	20	Sine Amplitude Vertical / (μm)	20

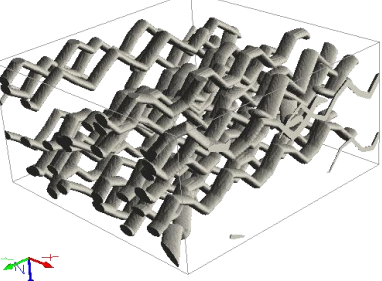
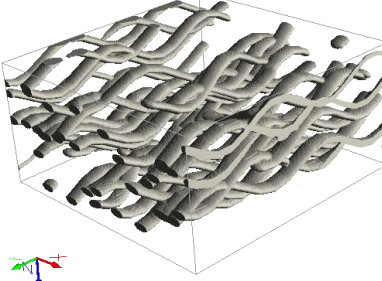
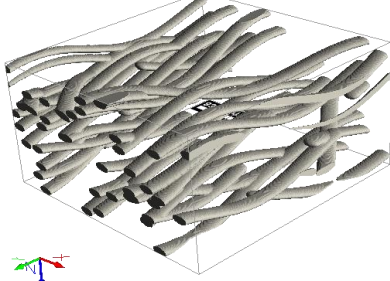
Observe the effect of the combination of sine parameters with a **Rotation Angle** that follows a uniform distribution in the interval 0 to 90°. The fibers appear not only curved but also rotated.

Fiber	Orientation	Shape	Torsion		
Orientation in Plane	Anisotropy				
Anisotropy in Plane	20				
Rotation Angle / (°)	<Uniformly in [0,90]>			Edit ...	

Fiber	Orientation	Shape	Torsion		
Shape Mode	Sine Fiber				
Segment Length / (μm)	25				
Sine Length Lateral / (μm)	200	Edit ...			
Sine Length Vertical / (μm)	200	Edit ...			
Sine Amplitude Lateral / (μm)	0	Edit ...			
Sine Amplitude Vertical / (μm)	20	Edit ...			

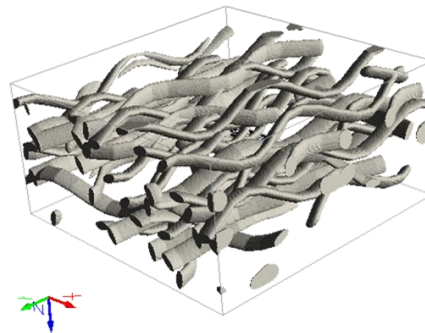
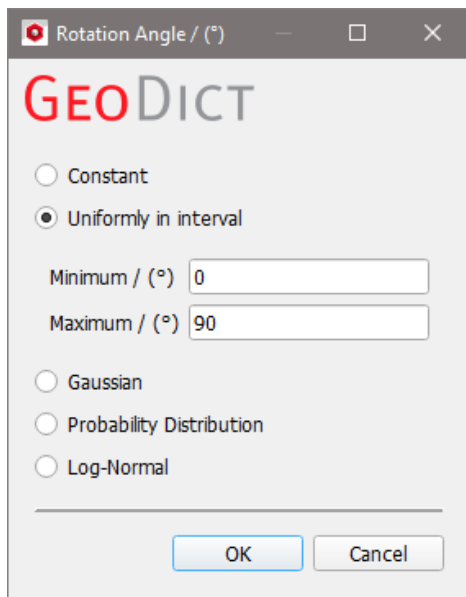

Torsion

Randomly curved fibers and sine fibers with elliptical, cellulose, and rectangular cross-section can be twisted to achieve torsion. The **Torsion Angle** defines how strongly the fibers are twisted within the first segment length. The **Maximum Torsion Change** adds a random component by allowing the torsion to change from one segment to the next.

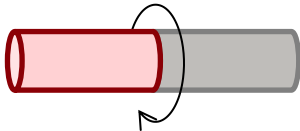

Fiber	Orientation	Shape	Torsion
Torsion Angle / (°)		<input type="text" value="0"/>	<input type="button" value="Edit ..."/>
Max Torsion Change / (°)		<input type="text" value="0"/>	

The following examples show the effect of varying the **Torsion Angle** on sine fibers with elliptical cross-section. The torsion angle is set as indicated (0°, 10° and 45°) while all other parameters are kept unchanged.

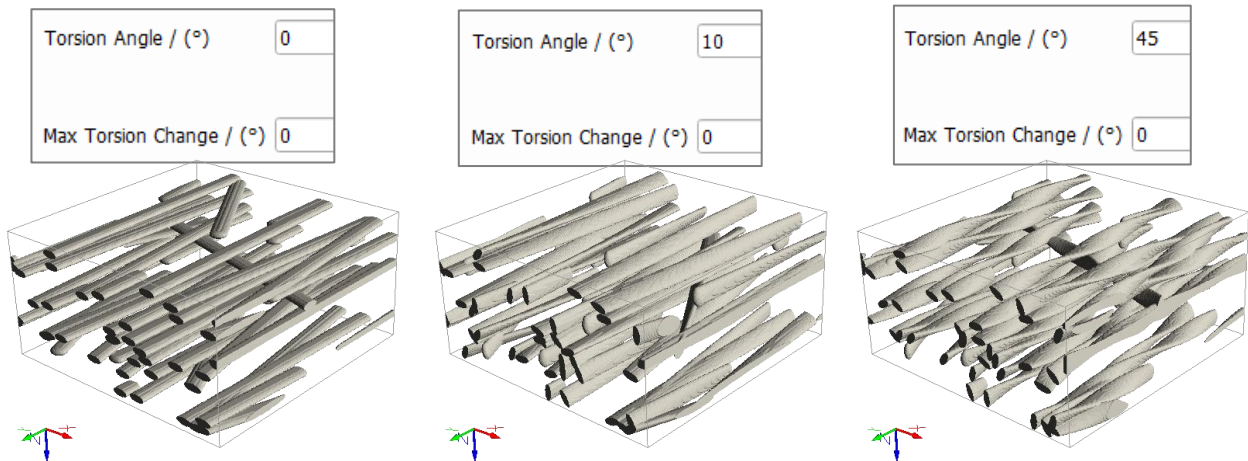

The association between **Torsion Angle** and **Segment Length** (under the **Shape** tab) can be observed in the following examples where the torsion angle is kept at a constant value of 45° whereas the segment length varies from the default 50 μm, to 25 μm, and finally to 10 μm.

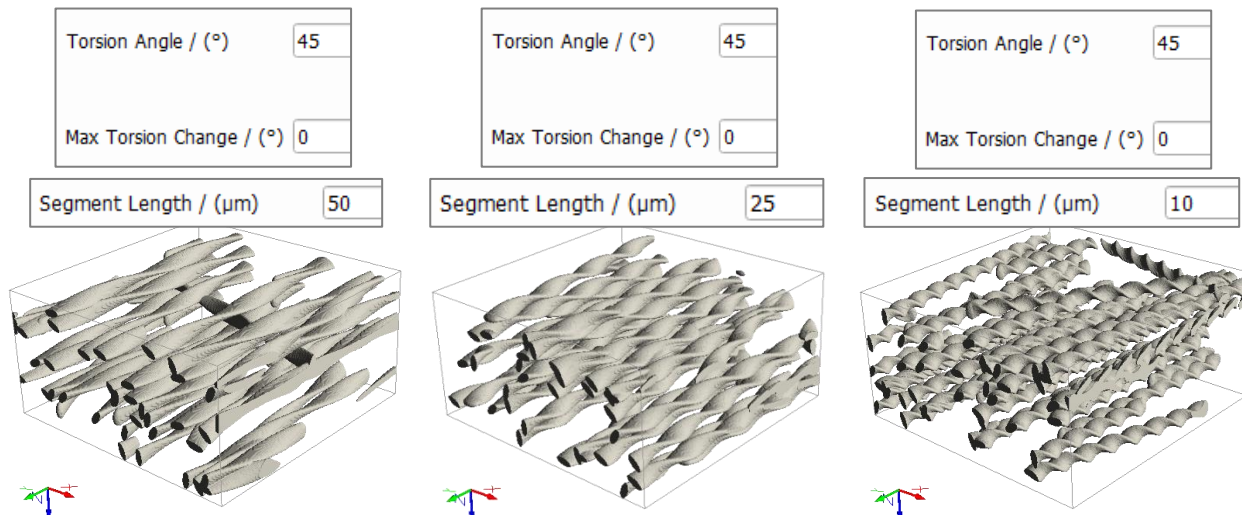

The **Maximum Torsion Change** determines the maximum allowed degree of change of the **Torsion Angle** from one segment to the next. The torsion change between different segments is uniformly distributed.

In the following examples, all randomness parameters are left unchanged, while the **Max Torsion Change** changes from 0° , to 15° , and finally to 30° . The segment length is always the default $50\ \mu\text{m}$.

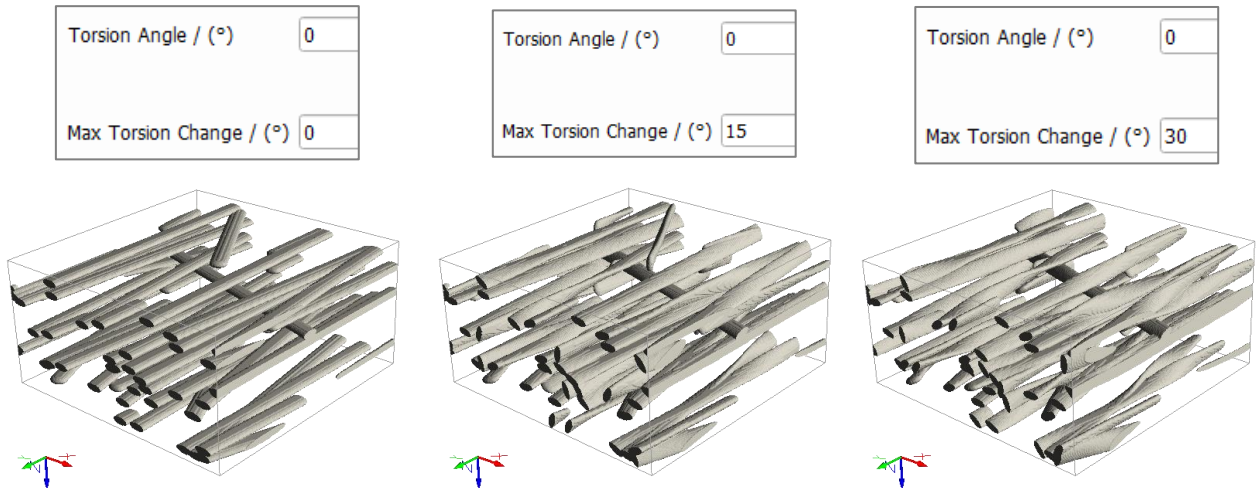

FIBER OVERLAP

The **Fiber Overlap** tab contains options dealing with how to define the material ID in locations where materials in the structure overlap. The overlap locations may exhibit other properties than those of the original materials.

Through the **Material ID Mode**, select between applying the Material ID based on the materials or the types of objects present in the paper structure.

Assigning a Material ID is part of the GeoDict Material Database concept, in which objects in the structure are ascribed to an individual material (e.g. glass, cellulose, PET) with specific physical properties.

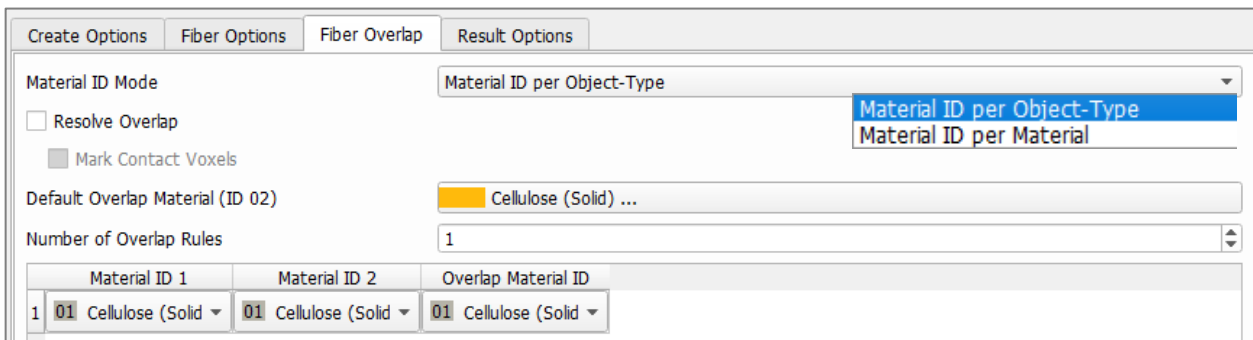

If **Resolve Overlap** is checked, the overlap is not assigned to a new material ID. Instead, the water-shed algorithm is used to decide which of the overlap voxels belongs to which object in a post-processing step. Thus, each overlap voxel is assigned to one specific object. This option needs more memory and a longer run-time.

In detail, the **Resolve Overlap** algorithm starts with computing a distance map for the overlap voxels, i.e. it computes the distance to the next object for each overlap voxel. On this distance map the watershed algorithm is run using all voxels belonging to an object as seeds. There, all voxels contained in the same object have the same material ID. Thus, the overlap area is filled with the object IDs according to the distance map.

To mark the contact voxels between the objects with a separate material ID, select **Mark Contact Voxels** and choose a **Contact Material** from the Material Data Base.

The voxels, where two or more object IDs meet, are marked as contact voxels, by reassigning them with a new material ID. Thus, the layer of contact voxels always has a thickness of two voxels.



In the following observe the resulting Material IDs for the overlap for not resolved, resolved and resolved overlap with marked contact voxels, while all other settings are kept the same.

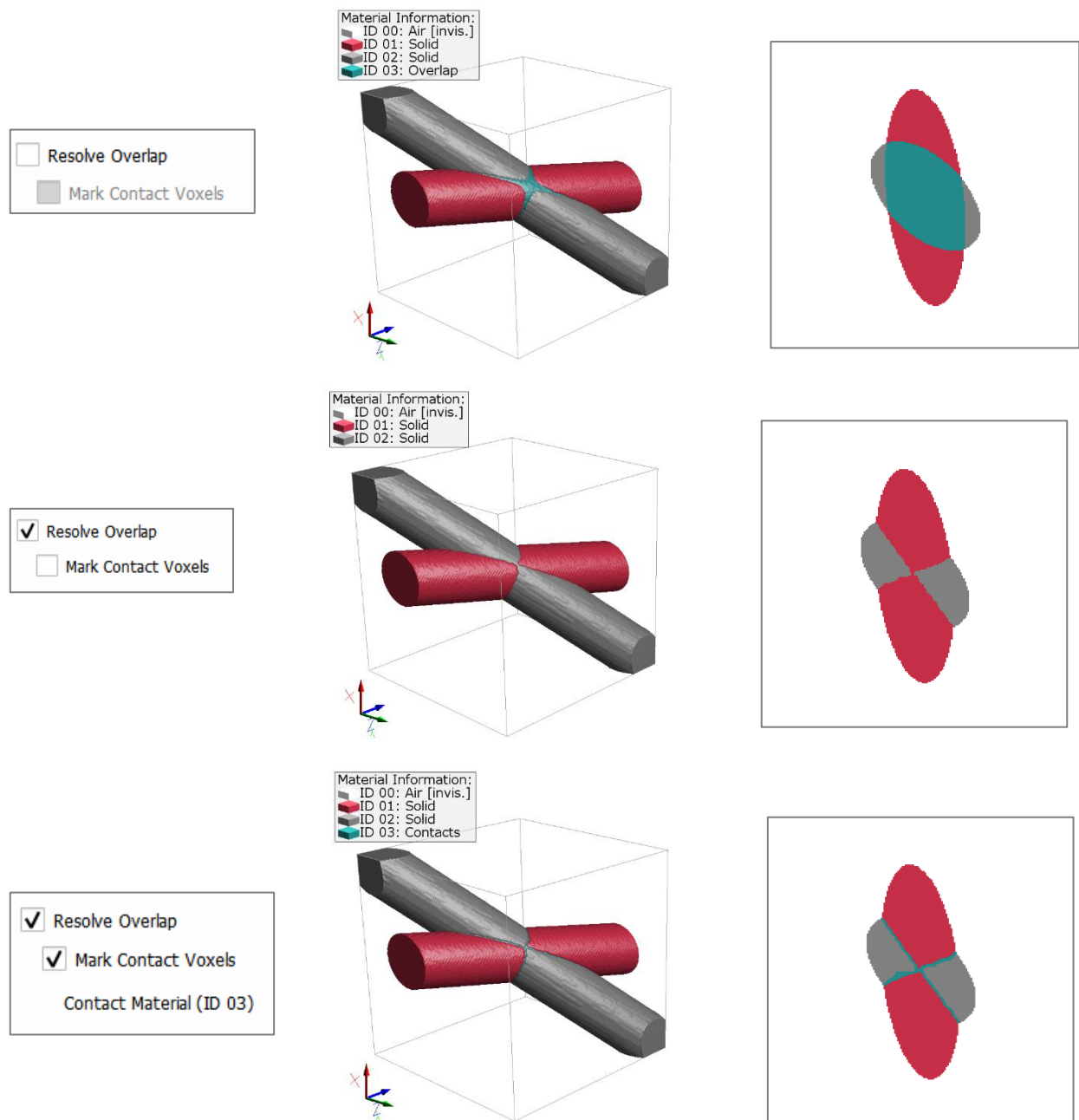

Default Overlap Material controls the material assigned to the regions where fibers of the newly generated structure overlap. The material ID of these regions is chosen by default as the next available material ID. The color settings and the constituent materials can be changed for each Material ID.

Overlap rules can be set to control how the overlap between materials should be handled in the structure about to be generated. The user can set up to 10 rules by selecting a number in the box for **Number of Overlap Rules**, and then define these rules in the panel below.

The materials shown in the panel (as buttons or pull-down menu) correspond to the [materials](#) selected under the **Fiber Options** tab for the structure about to be generated.

For example, as explained in page [14](#), the user simulates a structure made of plastic fibers that melt together and can set up a rule that defines what happens with the material ID at the melting location.

In the example shown below, three rules have been defined: The Overlap of objects with Material ID 1 (dark gray) will be assigned to ID 3 (light gray). The Overlap of objects with Material ID 2 (yellow) will be assigned to ID 4 (orange) and the overlap of ID 1 and ID 2 will be assigned to ID 5 (blue). For all other possible overlap cases, the **Default Overlap Material ID** is applied.

Material ID 1		Material ID 2		Overlap Material ID
1	01 Cellulose (Solid)	01 Cellulose (Solid)	03 Cellulose (Solid)	03 Cellulose (Solid)
2	02 Manual (Solid)	02 Manual (Solid)	04 Solid	04 Solid
3	01 Cellulose (Solid)	02 Manual (Solid)	05 Solid	05 Solid

Note, that the results for volume in the resulting report do not change for different overlap rules, as the values are computed before the post-processing is applied.

In the three examples given for **Resolve Overlap** the **Absolute Object Distribution** is shown on the right.

Absolute Object Distribution:		
	Count	Volume / (%)
Total	realized: 2 target: 2 error: 0.00	realized: 11.09 target: --- error: ---
Object Type 1	realized: 1 target: 1 error: 0.00	realized: 4.42 target: --- error: ---
Object Type 2	realized: 1 target: 1 error: 0.00	realized: 6.68 target: --- error: ---

For the volume percentages of the final structure refer to the **Statistics** tab above of the visualization area in GeoDict.

On the right the volume statistics are shown for the example with default overlap rules.

Statistics Camera (Y, Z) Structure Volume Field

Volume % 3D: ID 00 : 88.91 2D: ID 00 : 96.80

Objects 3D: ID 01 : 3.55 2D: 1
 ID 02 : 5.81
 ID 03 : 1.73

Components 3D: Pore : 88.91 2D: --
 Manual : 11.09

The red fiber has 3.55 % of the volume, the grey fiber has 5.81 % and the overlap 1.73 %.

In the result file the overlap volume is proportionally added to the volume of the overlapping fibers.

Here, the red fiber obtains $3.55\% + (1.73/2)\% = 4.415\%$. Rounded, this results in the 4.42 % shown in the report.



RESULT OPTIONS

PaperGeo always saves the generated structure as GeoDict structure file (*.gdt). The analytic data describing the position of the fibers in the structure is saved and placed in an automatically created result folder inside the chosen project folder in *.gdt format (**File** → **Choose Project Folder...** in the Menu bar). The *.gdt file, as well as the result folder, take the name entered as **Result File Name (*.gdr)** at the top of the Options dialog box.

An additional option to save the generated structure data is to check **Save Intermediate Result every** and enter a number of **Objects** in the box. As fibers are added to the paper structure during the generation, an intermediate result file is saved every time the number of placed fibers reaches the entered value.

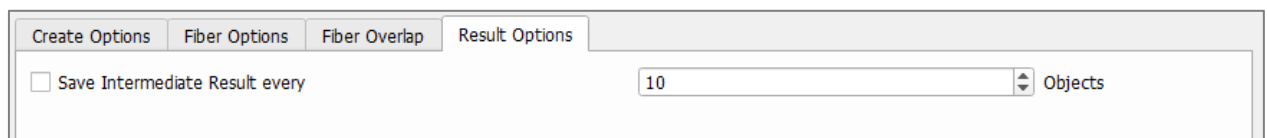

This option may be interesting when studying the properties of a series of increasingly dense paper structures.

After running the generation, the intermediate geometries can be found as *.gad analytic files in the result folder and can be loaded directly from the Result Viewer of the *.gdr result file.

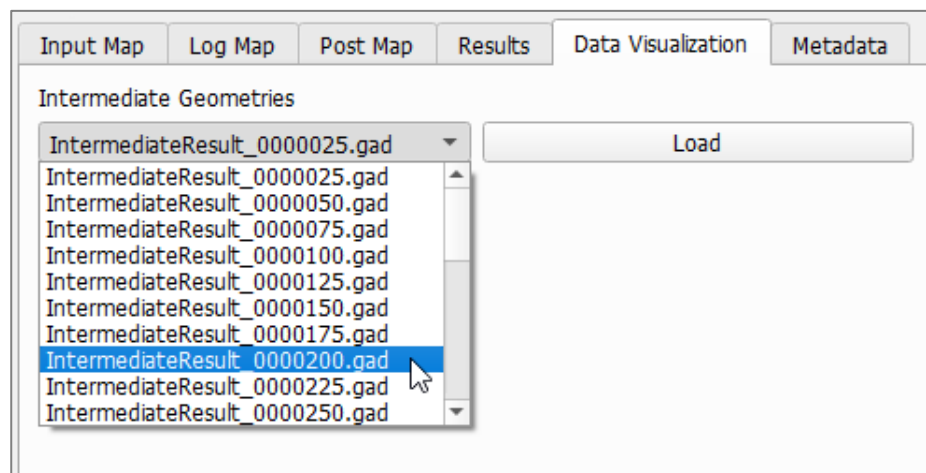

The parameters entered in the **Create Cellulose Fibers Options** dialog box can be saved into *.gps (GeoDict Project Settings) files and/or loaded from them. Remember to restore and reset your (or GeoDict's) default values through the icons at the bottom of the dialog box when needed and/or before every PaperGeo run.

Resting the mouse pointer over an icon prompts a ToolTip showing the icon's function to appear.

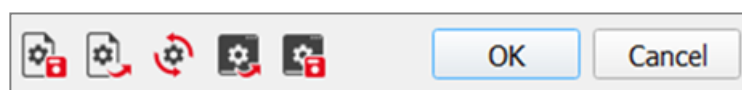

LAY-DOWN CELLULOSE FIBERS

With the selection of **Lay-Down Cellulose Fibers** from the **PaperGeo** section pull-down menu, fibers fall from their initial positions during the paper generation and form a paper structure.

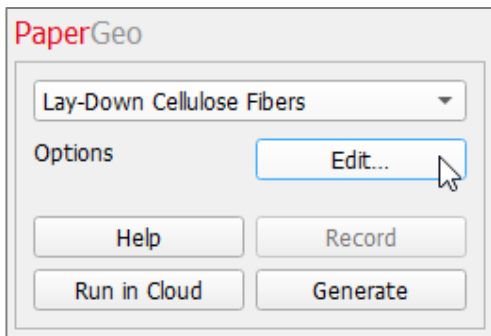

Clicking the **Lay-Down Options' Edit...** button opens the **Lay-Down Cellulose Fibers Options** dialog box.

At the top left, the name for the files containing the generation results can be entered in the **Result File Name (*.gdr)** box. The default name can be kept, or a new name can be chosen fitting the current project.

The available units (**m**, **mm**, **µm**, **nm** and **Voxel**) are selectable at the top right of the dialog box. When the units are changed, the entered values are adjusted automatically.

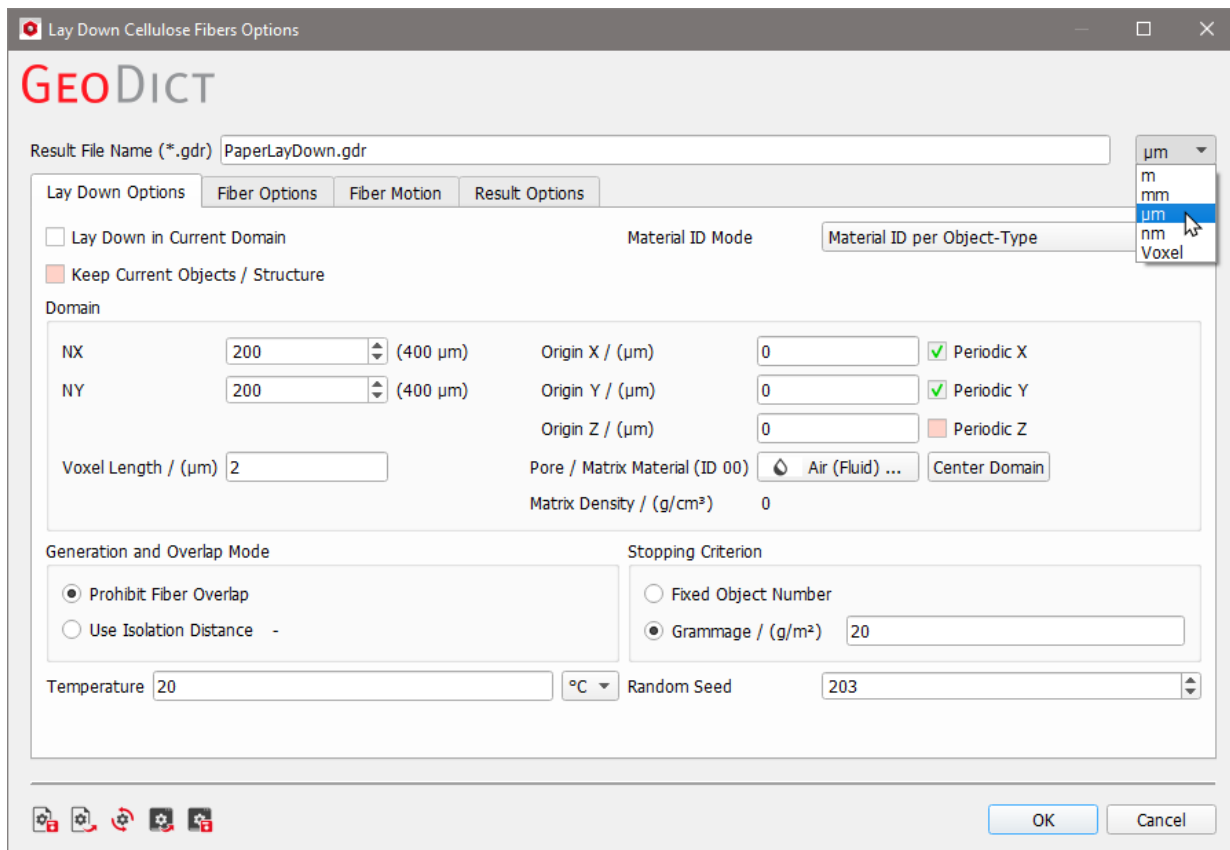

The options are organized through tabs.

- The **Lay Down Options** determine general properties of the resulting paper model such as size, resolution, and the stopping criterion for the generation.
- The **Fiber Options** define the geometrical properties of the individual fiber types such as cross-section, length, and orientation. Up to seven different fiber types can be used in one paper structure.

- **Fiber Motion** controls the way the fibers are laid down (initial fiber positions and their movements to the final position)
- The **Result Options** determine how the result files are saved.

The result files are saved in the chosen project folder (**File** → **Choose Project Folder** → **Select Project Folder**, in the Menu bar).

LAY DOWN OPTIONS

The general parameters of the paper structure are entered through the **Lay Down Options** tab, and grouped into **Domain**, **Overlap Mode**, and **Stopping Criterion** panels.

LAY DOWN IN CURRENT DOMAIN AND KEEP CURRENT OBJECTS / STRUCTURE

When checking **Lay Down in Current Domain**, the structure in memory is kept, to combine with the newly laid down paper structure.

Observe the effect that checking, or leaving un-checked, **Lay Down in Current Domain** and **Keep Current Objects / Structure** has on the generation of a paper structure. A (grey) woven structure is already in memory and (yellow) fibers fall in the Z+ direction.

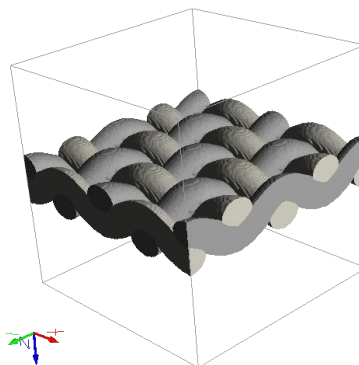

When **Lay Down in Current Domain** and **Keep Current Objects / Structure** are both checked (left image), the grey woven structure is kept, and the yellow fibers are laid over it.

When **Lay Down in Current Domain** is checked but **Keep Current Objects / Structure** is left unchecked (middle image), the yellow fibers fall on the weave, but the weave is deleted after the lay-down operation.

When **Lay Down in Current Domain** and **Keep Current Objects / Structure** are left unchecked (right image), the grey woven structure is not considered at all and the yellow fibers form a new sheet of paper. In that case, the height of the domain depends on the amount of the laid-down fibers.

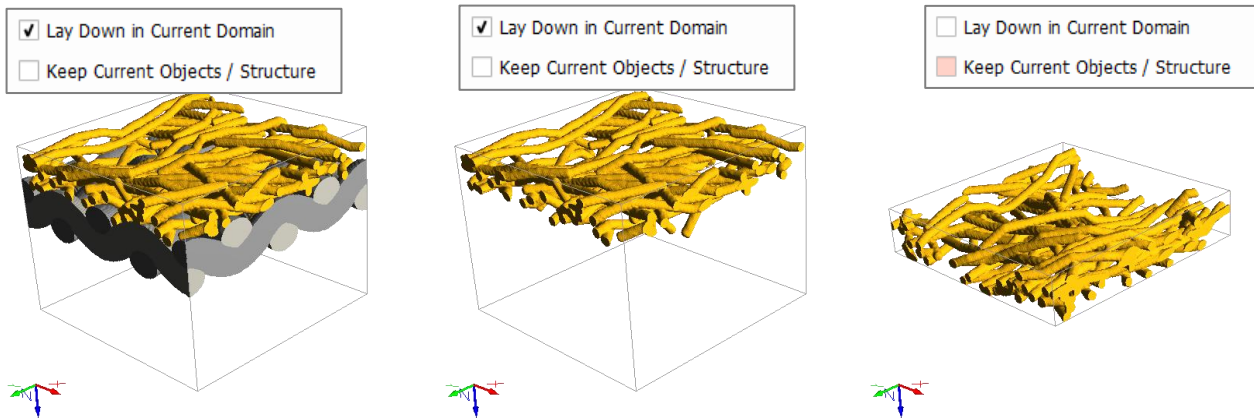

Notice that the size parameters, grouped under the **Domain** panel, cannot be modified when **Lay Down in Current Objects / Structure** is checked, because they are kept from the structure already in memory.

Lay Down in Current Domain and **Keep Current Objects / Structure** are useful tools when generating paper structures that are composed by several parts or layers. The previously generated structure is kept, and then, other layers or parts of the structure are added. The size of the final layered structure in the lay-down direction is adjusted automatically.

To use a structure as base of the laying down of cellulose fibers, open its GAD or GDT file and then enter the paper parameters in the **Lay Down Cellulose Fibers Options** dialog box.

If your intention is to lay down different cellulose fiber arrangements on the same initial structure, carry out the lay down and save the arrangement as GAD data (analytic data). Then the initial structure needs to be loaded before the next lay down run. Otherwise, the new fibers are laid down on the structure currently in memory, which is the previously laid down fiber arrangement.

The **Material ID Mode** pull-down menu allows selecting between applying the Material ID based on the materials or the types of objects (fibers) present in the fibrous structure.

Assigning a Material ID is part of the GeoDict Material Database concept, in which objects in the structure are ascribed to an individual material (e.g. glass, cellulose, PET) with specific physical properties.

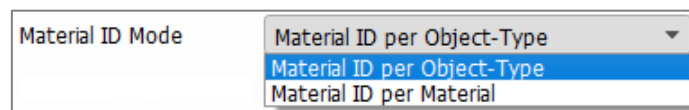

DOMAIN PARAMETERS

The **Domain** panel contains the parameters defining the structure size (**NX**, **NY**) in combination with the resolution (**Voxel Length**), as well as the **Origin** parameters, the **Periodicity** check boxes, the **Center Domain** button, and the **Matrix Material** pull-down menu.

As indicated in the example above in page 52, when **Lay Down in Current Domain** is unchecked, the size of the domain in Z-direction (paper thickness) is determined by the thickness of the laid-down fiber structure.

The periodicity boxes are checked (and disabled for the user) for **Lay Down Cellulose Fibers**, because the objects are always laid down periodically.

Domain				
NX	200 (400 μm)	Origin X / (μm)	0	<input checked="" type="checkbox"/> Periodic X
NY	200 (400 μm)	Origin Y / (μm)	0	<input checked="" type="checkbox"/> Periodic Y
Voxel Length / (μm)	2	Origin Z / (μm)	0	<input type="checkbox"/> Periodic Z
		Pore / Matrix Material (ID 00)	<input type="text" value="Air (Fluid) ..."/>	<input type="button" value="Center Domain"/>
		Matrix Density / (g/cm^3)	0	

NX, NY, and Voxel Length

In GeoDict, a structure is internally represented by rectangular 3D arrays of equally sized boxes, hereafter called volume elements or **voxels**. **NX** and **NY** are the number (N) of voxels in X and Y directions. Varying the values for NX and NY has the effect of changing the size of the piled structure in the given direction.

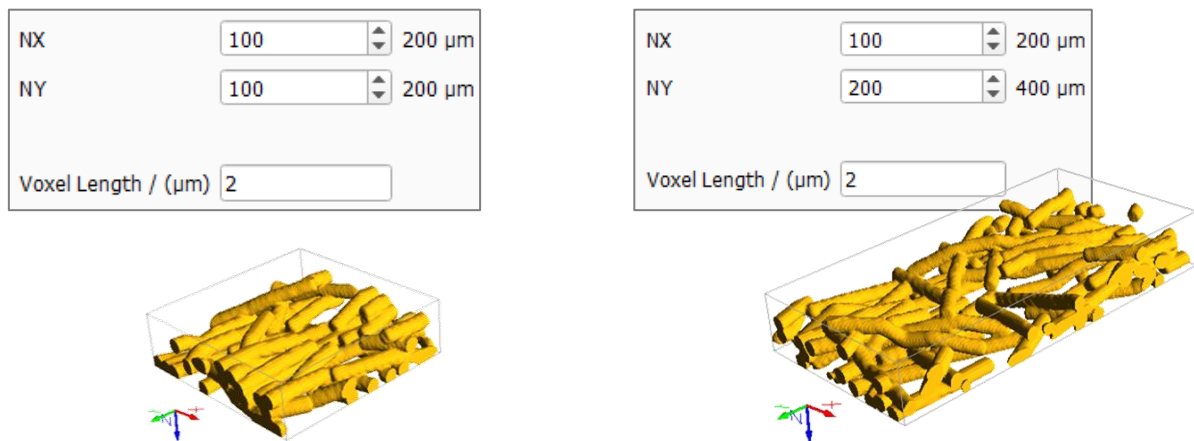

The **Voxel Length** is the size of one voxel in the chosen units. Low values for voxel length in combination with high values for NX and NY result in a higher resolution, but also in a higher computational time. After setting the values of NX, NY, and Voxel Length, the physical structure size is automatically displayed in the chosen units.

Observe how keeping the structure size a constant 200 μm x 200 μm (grammage 15 g/m^2) while decreasing the Voxel Length from 2 μm to 1 μm has the effect of refining

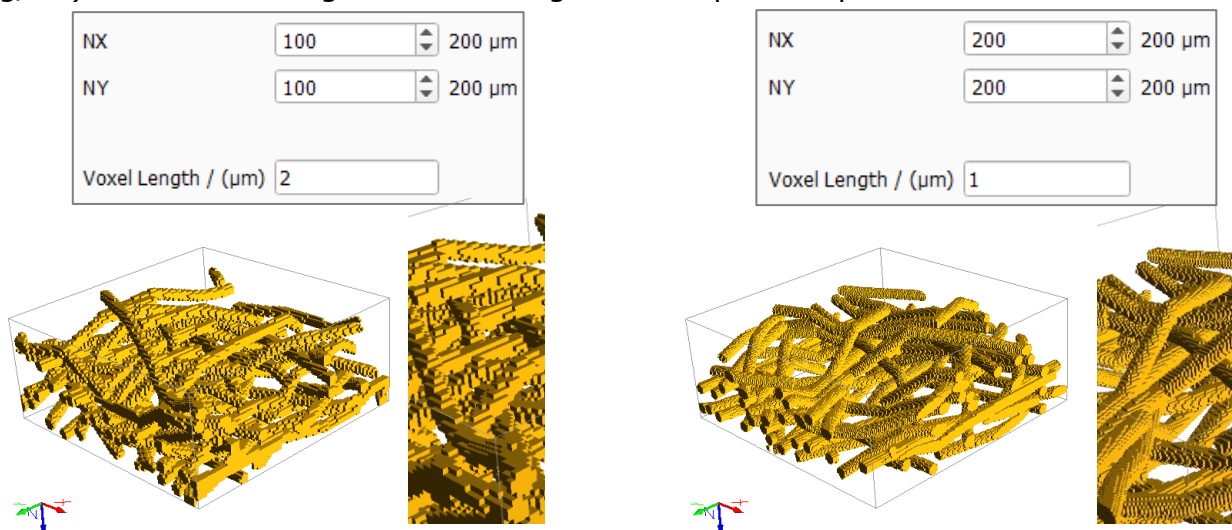

the laid down fibers by increasing the resolution. Since the voxel length has decreased to half, the size of the structure is kept by doubling the **NX** and **NY** values from 100 to 200.

Origin x, Origin y, and Origin z, Center Domain, and Periodicity

The **Origin X**, **Origin Y**, and **Origin Z** parameters, together with the **Center Domain** button, determine the placement of the laid down paper structure in the physical space in the same way as seen above for **Create Cellulose Fibers** (page [8](#)).

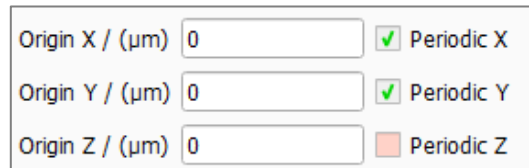

The screenshot shows a panel with three rows of input fields and checkboxes. The first row is 'Origin X / (μm)' with a text box containing '0' and a checked checkbox labeled 'Periodic X'. The second row is 'Origin Y / (μm)' with a text box containing '0' and a checked checkbox labeled 'Periodic Y'. The third row is 'Origin Z / (μm)' with a text box containing '0' and an unchecked checkbox labeled 'Periodic Z'.

Structures generated by laying-down cellulose fibers are, by default, periodic in the X- and Y-directions, but cannot be made periodic for the direction from which they fall (Z-direction).

Pore/Matrix Material and Matrix Density

Choose the material of the matrix around the fibers from the material selector, as explained in on page [11](#).

GENERATION AND OVERLAP MODE

The options in the **Generation and Overlap Mode** panel control the relative position among the fibers in the generated structure (or with the objects of the structure currently in memory).

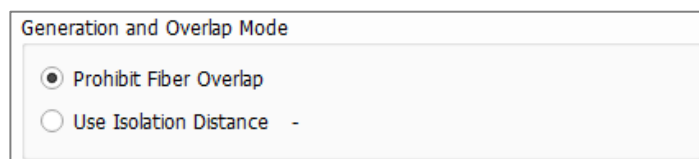

The screenshot shows a panel titled 'Generation and Overlap Mode' with two radio button options. The first option is 'Prohibit Fiber Overlap' which is selected. The second option is 'Use Isolation Distance' which is not selected.

Fibers may touch (but not overlap) when **Prohibit Fiber Overlap** is selected.

Fibers may not touch when **Use Isolation Distance** is selected, and a positive value is entered. Then, the gaps between fibers have at least this preset distance. The choice of **Use Isolation Distance** may lead to long computation times when working with large structures and/or small segment lengths for the fibers. How to control the segment length is described starting on page [38](#).

When choosing a negative isolation distance, fibers can overlap by this value. This option can be used to simulate fibers that melt together, or that deform when touching other fibers.

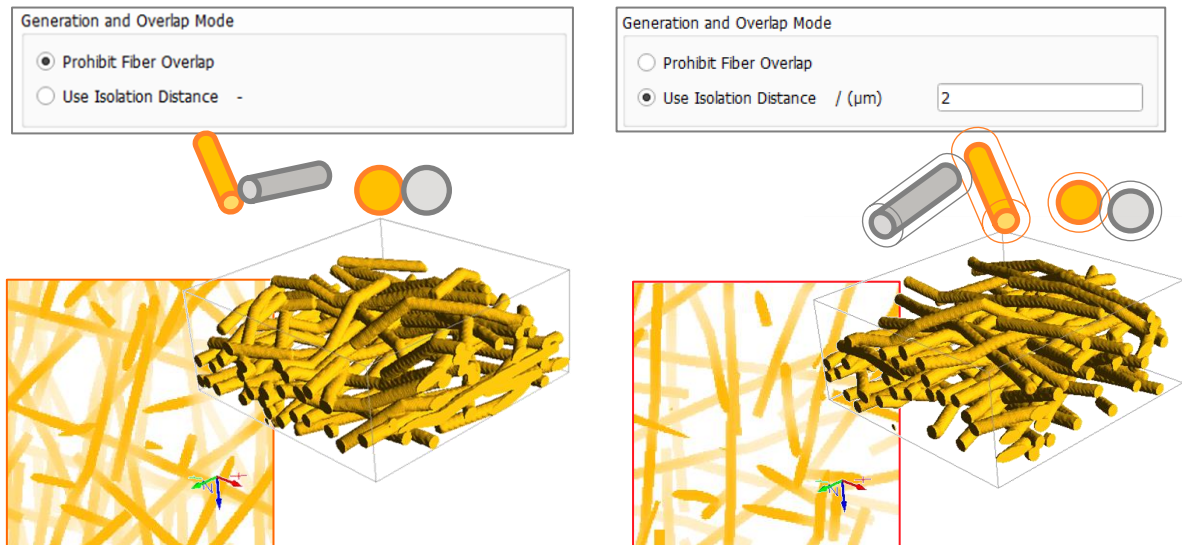

STOPPING CRITERION

The parameters **Fixed Object Number** and **Grammage**, in the **Stopping Criterion** panel, control whether the pile process should be continued, or the material is “ready”. The analysis of the results file (*.gdr file) shows any disparity between the achieved result values and the desired ones.

These options work in the same way as seen above for **Create Cellulose Fibers** (pages 15ff.).



TEMPERATURE

When **Grammage** is chosen as **Stopping Criterion**, the temperature to be considered for the generation of the lay-down paper structure must be entered because the density of the structure’s constituent materials might be temperature-dependent.

Choose the temperature in Kelvin, Celsius, or Fahrenheit.



RANDOM SEED

Random Seed initializes the random number generator behind the structure generator. Changing its value produces different sequences of random numbers and hence, different realizations of the specified structure. If all settings are equal, generating with the same **Random Seed** value produces exactly the same structure. **Random Seed** is a non-negative integer number.

Varying the **Random Seed** allows generating different samples of paper structures with the same properties. In the following examples, all parameters are unchanged while the Random Seed changes with every lay-down run (e.g. 199, 12, 89).

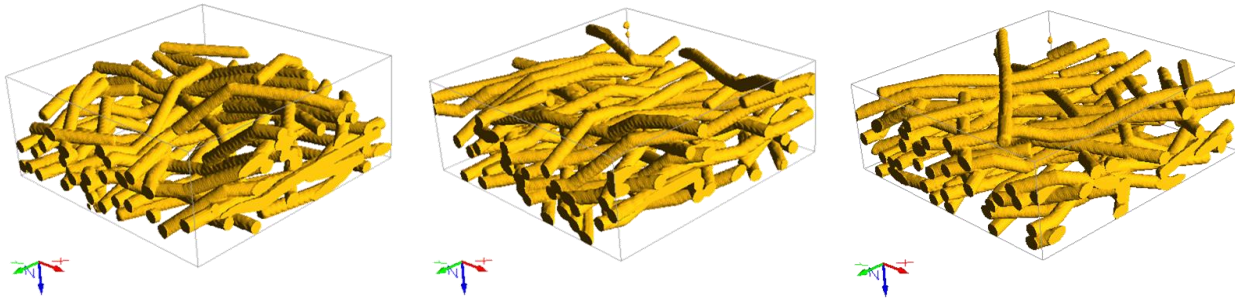

FIBER OPTIONS

The fibers available to **Lay-Down Cellulose Fibers** are organized and listed in panels in a way almost identical to the one for creating paper structures (**Create Cellulose Fibers**). The fiber list is limited to Short fibers of four different cross-sections. See the detailed explanations above, starting on [page 22](#).

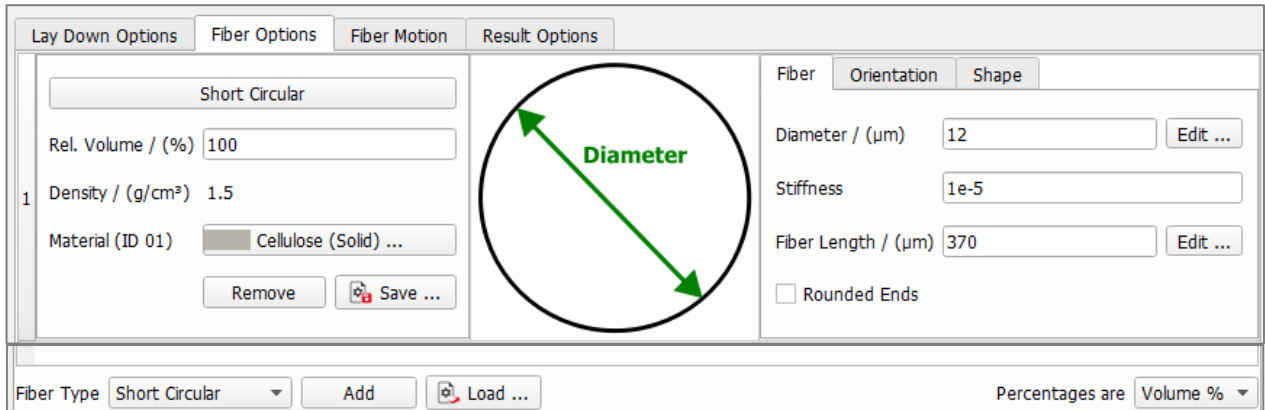

The center position of the cellulose fibers is a result of the lay-down process and cannot be specified.

On the contrary, a value for fiber **Stiffness** can be entered only when laying down fibers. Stiffness is a property of the fiber type. Values for **Stiffness** can vary from 0 to infinity. A high value indicates a stiff and inflexible fiber, while low values (such as the default 1e-5) indicate a pliable fiber that bends easily over other structures.

As a result of the lack of bending, a paper structure generated by laying down stiff fibers is thicker than a paper structure in which soft fibers are laid down. This side effect provides an additional way to control the thickness of the paper structure.

In the following examples, stiff or soft short-circular randomly curved fibers are laid down over a woven structure. All parameters are unchanged while the fiber **Stiffness** is set as indicated.

Observe that the sheet is thicker, and the domain is larger for the structure on the right, as side-effect of the higher stiffness of the fibers.

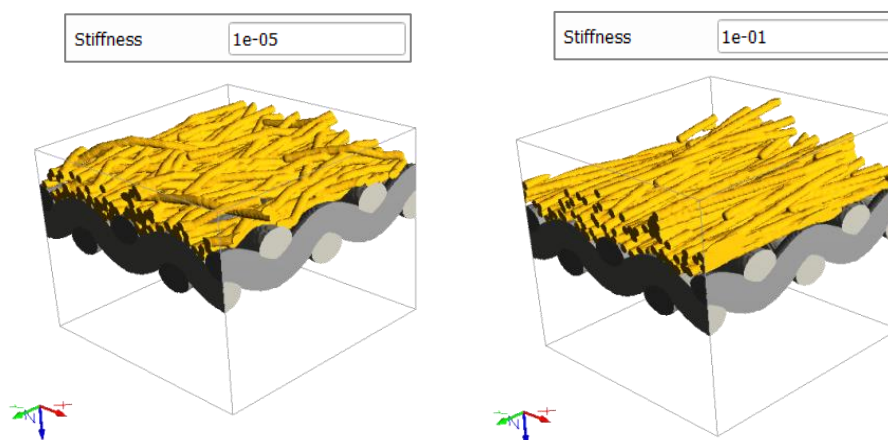

FIBER MOTION

The **Fiber Motion** parameters, controlling the fibers' movement during the lay-down process, are grouped in the **Lay Down Step** panel.

To refine the result, the available parameters can be used, namely **Number of Shifts**, **Maximum Shift Angle**, **Number of Rotations** per shift, and **Maximum Rotation Angle**.

Additionally, falling fibers can be deformed when checking **Deform fibers** and the desired **Number of Deformations** can be entered.

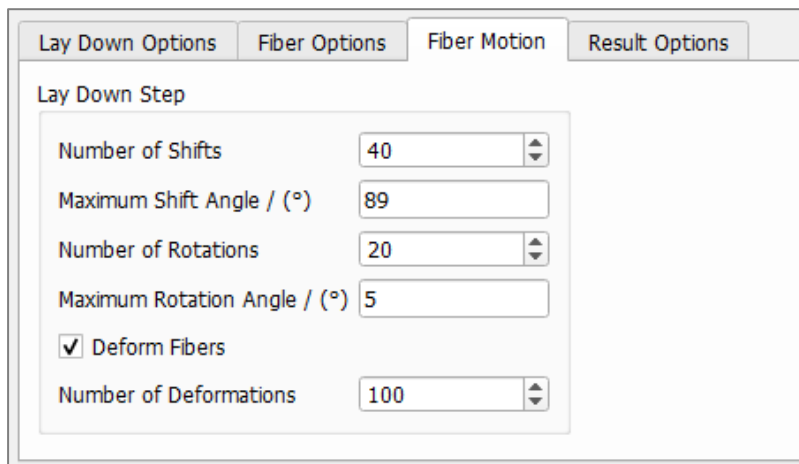

Throughout the lay-down process, the fibers fall and roll to their final location in the paper structure. During the fall, the fibers shift and rotate as many times as defined by the values of **Number of Shifts** and **Number of Rotations** before they come to rest at the bottom of the structure.

Low values for shifts and rotations produce structures with fibers which settle earlier compared to larger values of these parameters, resulting in thicker paper structures. The **Maximum Shift Angle** and **Maximum Rotation Angle** restrict the angle that the objects can adopt during the fall with respect to the lay-down plane.

Observe the effect of setting a high or a low **Number of Shifts** on the final position of fibers and the thickness (Z-direction) of a laid down paper structure.

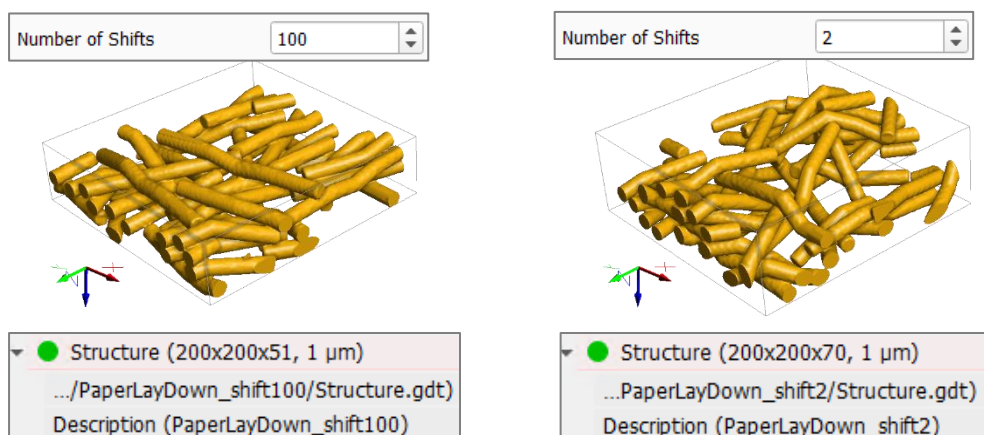

RESULT OPTIONS

The Lay-Down **Result Options** are completely analogous to the Create Result Options explained above ([pages 49ff.](#)).

ADD BINDER

To generate realistic models of paper structures, the simulation of binder addition during paper manufacturing is essential. In **PaperGeo**, the process **Add Binder** reproduces the coating and bonding with binder of paper fibers, filler, and other components, often done to improve structural integrity, water retention, or finish to the paper sheet.

Add Binder to a structure consists of adding material in the shape of a concave meniscus in the pore space where surfaces in that structure's material get close together. If there is no pore material in the structure, a warning is given.

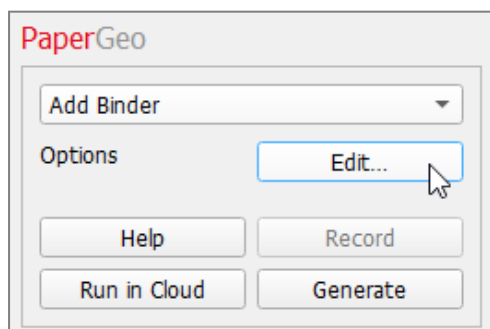

For hollow fibers, such as cellulose fibers, the algorithm under Add Binder needs analytic data (GAD file or GDT - GeoDict 2019 or newer) to discern that the empty voxels inside the fibers are not part of the pore space. Without analytic data, i.e. when using voxelized models (old GDT file), binder is also added inside the hollow fibers, which is physically inaccurate.

Material Information:
 ID 00: Air [Invis.]
 ID 01: Polyethylene (PET)
 ID 02: Polypropylene

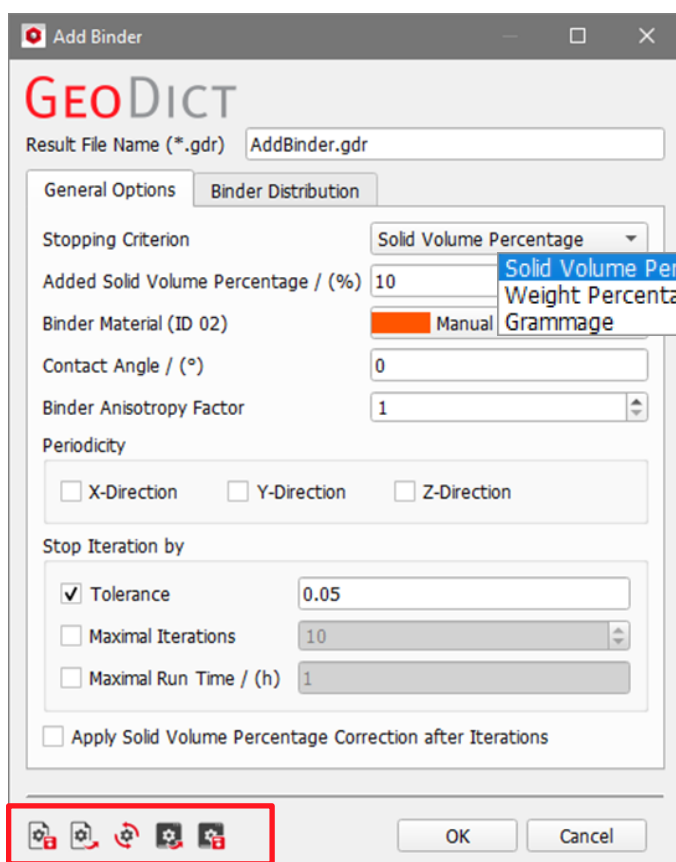
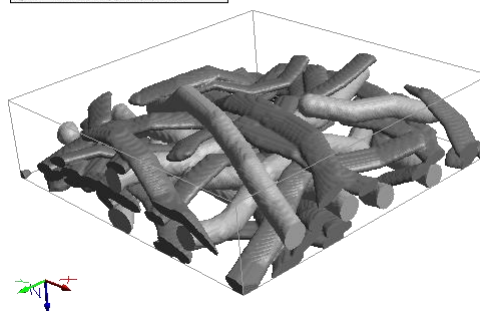

Clicking the **Options' Edit...** button opens the **Add Binder** dialog. Clicking **OK** in it closes the dialog and returns to the **PaperGeo** section. Clicking **Generate** starts the process.

At the top of the **Add Binder** dialog, the name for the file containing the results of adding binding can be entered in the **Result File Name (*.gdr)** box. The default name can be kept, or a new name can be chosen, fitting the current project

GENERAL OPTIONS

STOPPING CRITERION

The user may choose the most practical stopping criterion when adding binder. The chosen **Stopping Criterion** interrupts the addition of binder when it is reached. The possible stopping criteria are Solid Volume Percentage, Weight Percentage, and Grammage.

Solid Volume Percentage

The process is stopped if the binder volume reaches the desired **Added Solid Volume Percentage**.

The **Binder Material** is assigned to the next available material ID, and the appropriate material to be used as binder should be selected from the material database by clicking the button.

General Options		Binder Distribution
Stopping Criterion	Solid Volume Percentage ▾	
Added Solid Volume Percentage / (%)	10	
Binder Material (ID 02)	 Manual (Solid) ...	
Contact Angle / (°)	0	
Binder Anisotropy Factor	1	

Weight Percentage

The weight of binder reaches a certain percentage of the weight of material.

As seen above for the Solid Volume Percentage stopping criterion, the **Binder Material** is assigned to the next available material ID, and the appropriate **Binder Material** should be selected from the material database by clicking the button.

It is necessary to set the density for the structure's material (**Material Density**) and for the binder material (**Binder Density**) both in g/cm^3 , as well as the desired (weight) percentage of binder material to structure material (**Binder Weight Percentage**, in %). That is, a **Binder weight percentage** of 20 means that there are 20 g of binder added per 100 g of objects in the structure.

General Options		Binder Distribution
Stopping Criterion	Weight Percentage ▾	
Binder Weight Percentage / (%)	20	
Binder Material (ID 02)	 Manual (Solid) ...	
Material Density / (g/cm^3)	1	
Binder Density / (g/cm^3)	2.7	
Contact Angle / (°)	0	
Binder Anisotropy Factor	1	

In the following example, two types of binder (high density: 5 g/cm³ and low density: 0.5 g/cm³) are added to a structure material with a density of 1.1399 g/cm³. Setting a **Binder weight percentage** of 20% (20 g binder/100 g objects), the amount of binder material deposited is much larger when the binder is less dense.

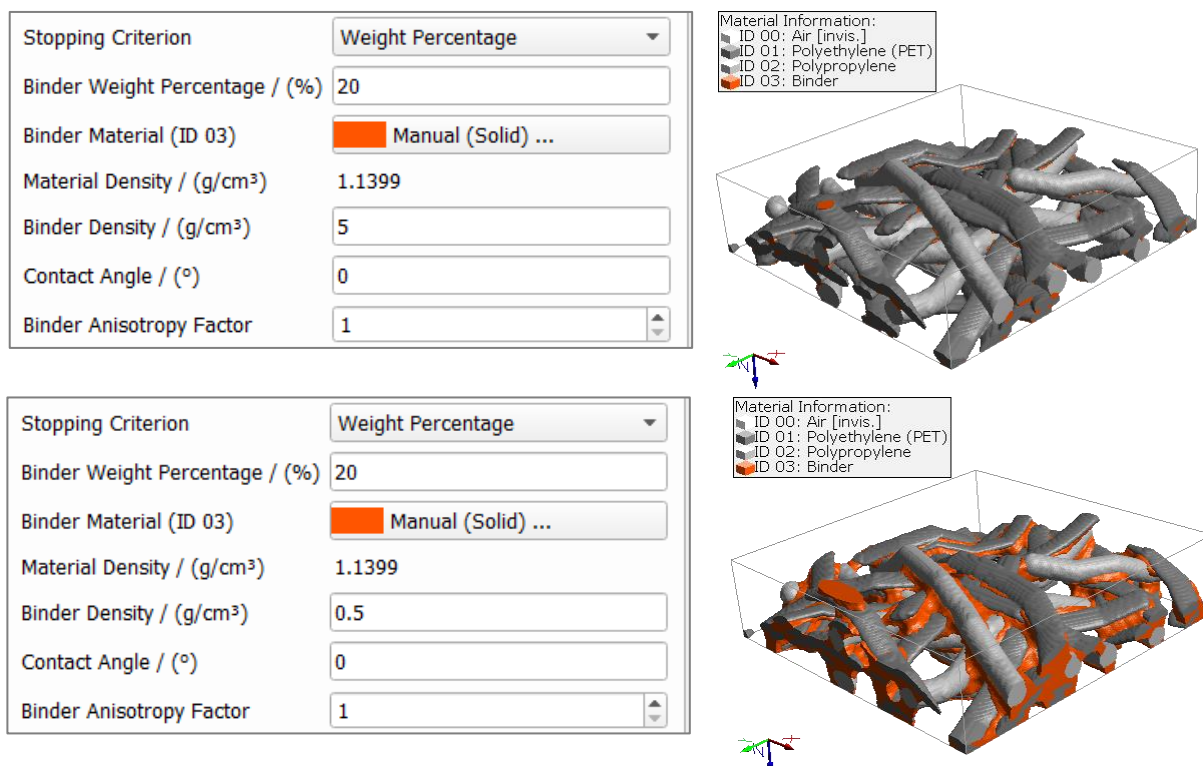

For **Weight Percentage**, when **Manual** or **Undefined** are selected, the user must enter the density of the binder (**Binder Density [g/cm³]**). If a material is selected from the database, the **Binder Density** (in g/cm³) of the binder material is automatically entered. If a manual material is used frequently, it is useful to save it to the material database.

Grammage

The addition of binder stops when the **Added Grammage** (material and binder, g/m²) is reached.

As seen above for the Solid Volume Percentage stopping criterion, the **Binder Material** is assigned to the next available material ID and the appropriate material to be used as binder should be selected from the material database by clicking the button.

General Options	Binder Distribution
Stopping Criterion	Grammage
Added Grammage / (g/m ²)	10
Binder Material (ID 02)	Manual (Solid) ...
Binder Density / (g/cm ³)	2.7
Contact Angle / (°)	0
Binder Anisotropy Factor	1

For **Grammage**, when **Manual** or **Undefined** are selected, the density of the binder is not automatically taken from the database and the user must enter it manually (**Binder Density [g/cm³]**). If a manual material is used frequently, it is useful to save it to the material database.

CONTACT ANGLE

The **Contact Angle** defines the angle in which the binder is deposited in relation to the materials in the structure. Values between 0° and 60° are accepted. The contact angle helps to optimize and realistically model the addition of binder.

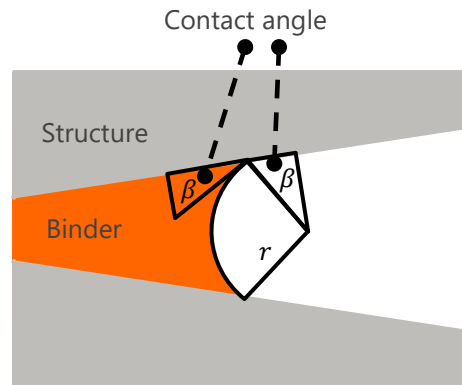

Observe the effect of adding binder with a **Contact Angle** of 0° or 45°.

Stopping Criterion	Solid Volume Percentage
Added Solid Volume Percentage / (%)	5
Binder Material (ID 02)	Manual (Solid) ...
Contact Angle / (°)	0
Binder Anisotropy Factor	1

Material Information:

- ID 00: Air [invis.]
- ID 01: Polyethylene (PET)
- ID 02: Polypropylene
- ID 03: Binder

Material Information:

- ID 00: Air [invis.]
- ID 01: Polyethylene (PET)
- ID 02: Polypropylene
- ID 03: Binder

Material Information:

- ID 00: Air [invis.]
- ID 01: Polyethylene (PET)
- ID 02: Polypropylene
- ID 03: Binder

Stopping Criterion	Solid Volume Percentage
Added Solid Volume Percentage / (%)	5
Binder Material (ID 02)	Manual (Solid) ...
Contact Angle / (°)	45
Binder Anisotropy Factor	1

Material Information:

- ID 00: Air [invis.]
- ID 01: Polyethylene (PET)
- ID 02: Polypropylene
- ID 03: Binder

Material Information:

- ID 00: Air [invis.]
- ID 01: Polyethylene (PET)
- ID 02: Polypropylene
- ID 03: Binder

Material Information:

- ID 00: Air [invis.]
- ID 01: Polyethylene (PET)
- ID 02: Polypropylene
- ID 03: Binder

BINDER ANISOTROPY FACTOR

The **Binder Anisotropy Factor** allows to control the grade of binder anisotropy in the X-Y-plane. If the factor is the default value of 1, the binder is distributed isotropically. By choosing larger values, the binder is distributed in the XY-plane but then, the contact angle value is not accurate anymore.

Observe the effect of changing the **Binder Anisotropy Factor** from (the default) 1 to 3 when adding binder. With a binder anisotropy factor of 3, the binder is added in the direction of the XY-plane.

Stopping Criterion	Solid Volume Percentage ▾
Added Solid Volume Percentage / (%)	5
Binder Material (ID 02)	Manual (Solid) ...
Contact Angle / (°)	0
Binder Anisotropy Factor	1

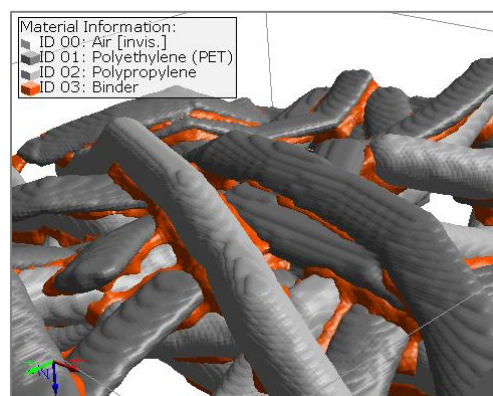

Stopping Criterion	Solid Volume Percentage ▾
Added Solid Volume Percentage / (%)	5
Binder Material (ID 02)	Manual (Solid) ...
Contact Angle / (°)	0
Binder Anisotropy Factor	3

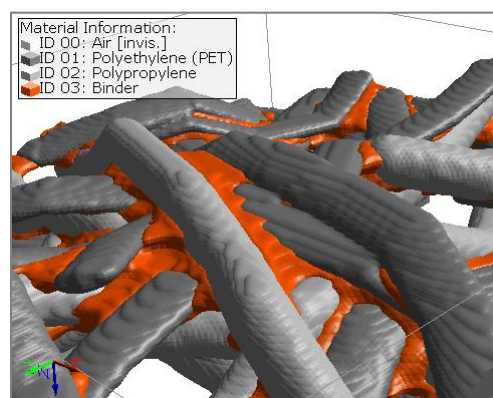

PERIODICITY

When the 3D-structure model is periodic in one or more directions, the binder can be added periodically: in all directions, only in the selected direction (**Periodic X**, **Periodic Y** and/or **Periodic Z**), or non-periodically. Adding binder periodically in certain direction(s) only makes sense if the 3D-structure model is periodic in that/those direction(s).

STOP ITERATION BY

PaperGeo adds binder through an iterative process, which is repeated until the stopping criterion is fulfilled.

The stopping of the iterative process is controlled by checking and setting values for **Tolerance**, **Maximal Iterations**, or **Maximal Run Time (h)**.

Tolerance is the allowable amount of absolute variation between the entered target value for the selected stopping criterion (Solid Volume Percentage, Weight Percentage, or Grammage) and the value reached by the algorithm.

The user may also choose to have the addition of binder stop by a certain number of **Maximal Iterations** or after a certain **Maximal Run Time (h)**.

Information on the stopping of the algorithm and the number of iterations can be found in the Result Viewer of the *.gdr result file.

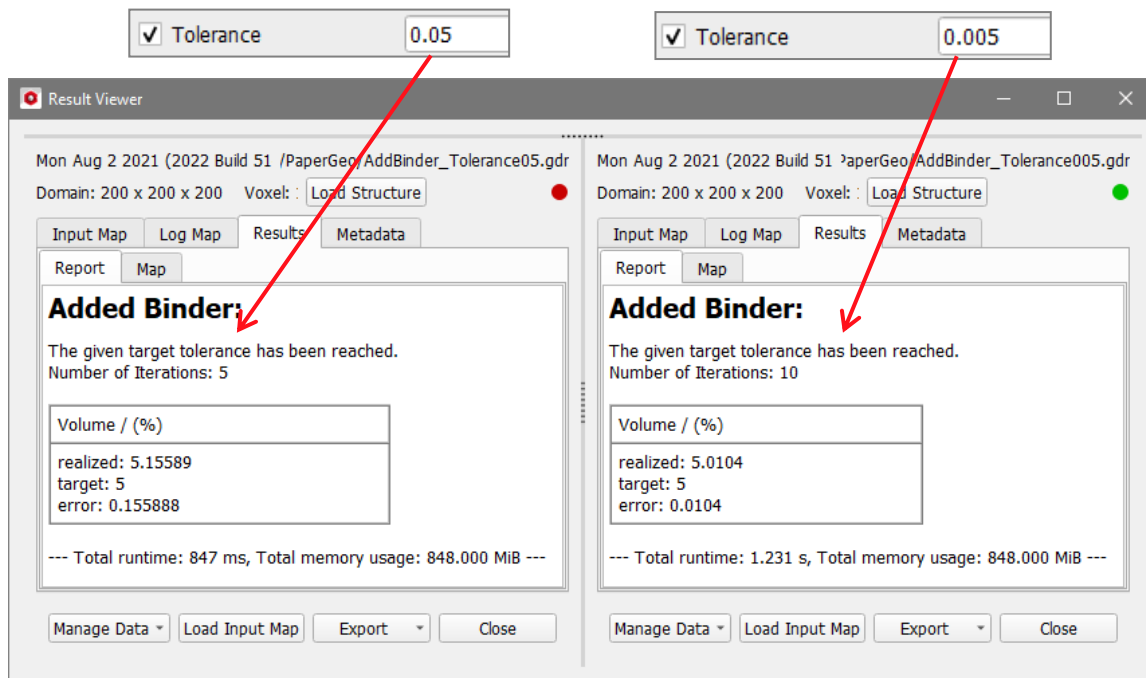

APPLY SOLID VOLUME PERCENTAGE / WEIGHT PERCENTAGE / GRAMMAGE CORRECTION AFTER ITERATIONS

Adding binder with the algorithm adds binder until the iteration stops according to the given stopping criteria. Thus, the given value for **Solid Volume Percentage / Weight Percentage / Grammage** is usually not reached precisely and there are few cases, where the algorithm even does not converge.

If the amount of binder should be reached perfectly, it can be corrected, by checking **Apply Solid Volume Percentage Correction after Iterations**, **Apply Weight Percentage Correction after Iterations** or **Apply Grammage Correction after Iterations** depending on the chosen stopping criterion.

Selecting this option adds or removes binder surface voxels after the iterations are stopped till the given binder value is reached precisely.

Note, that this reduces the **Contact Angle** precision.

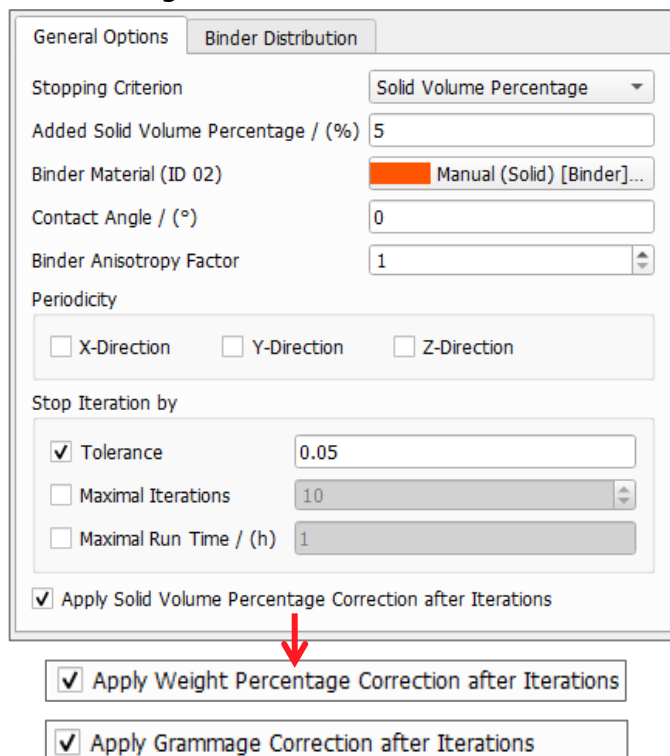

In detail, if the realized amount of binder after the iterations is larger than the target value, voxels are removed from exposed positions, i.e. voxels with only one contact to another binder voxel.

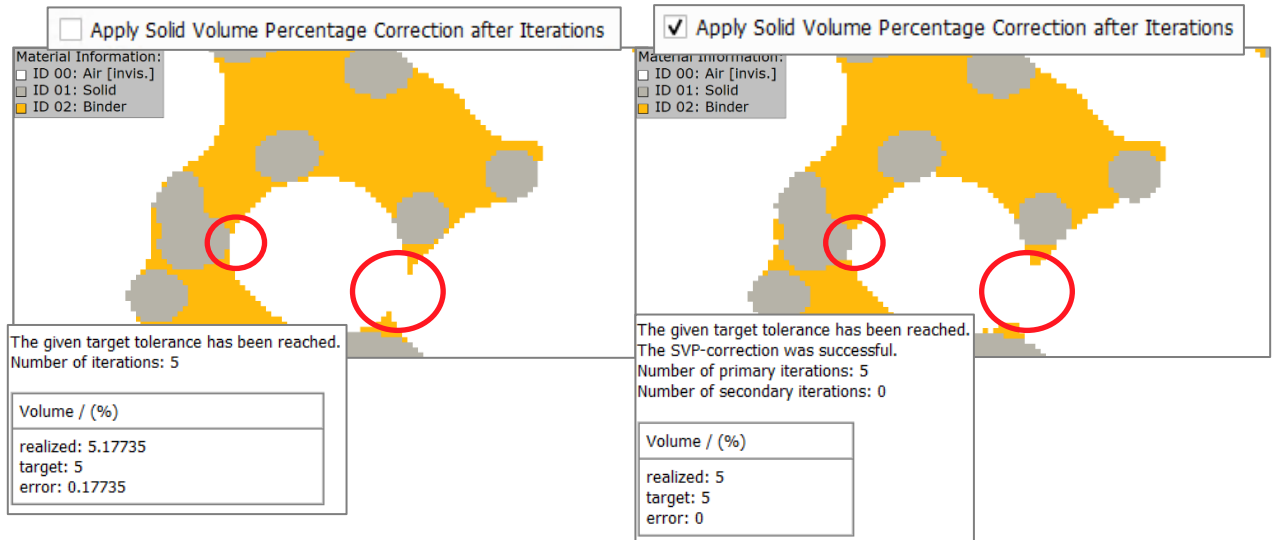

In the other case, if the amount of binder is smaller than the target value, the algorithm adds voxels on positions with the most binder voxel neighbors.

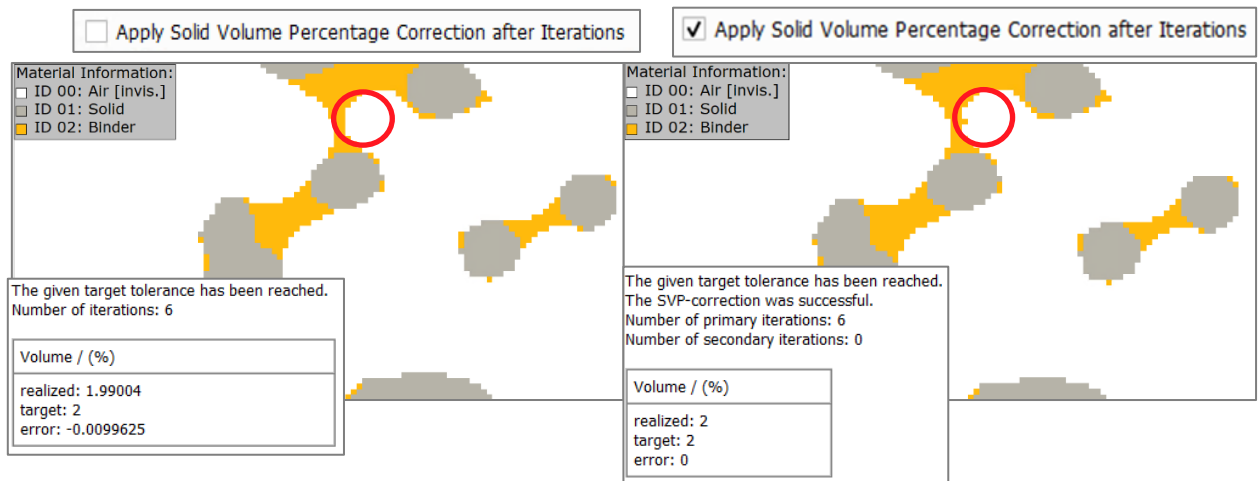

BINDER DISTRIBUTION

In real life, the process of adding binder to the material is affected by gravity and the viscosity of the binder, leading to inhomogeneous distributions. This effect can be modeled by defining a distribution of the binder under the **Binder Distribution** tab.

The default distribution is **Homogeneous**, but it can be changed to a **Density Distribution in Z-Direction** to allow the modeling of inhomogeneity.

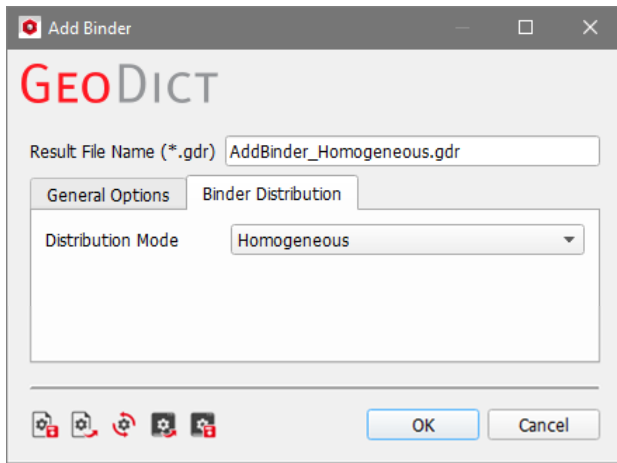

Material Information:
 ID 00: Pore [invis.]
 ID 01: Solid
 ID 02: Binder

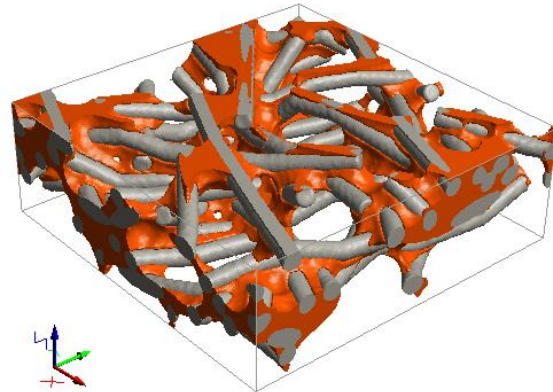

To model a **Density Distribution in Z-Direction**, we remove the inlet from the example by cropping it (**Model** → **ProcessGeo** → **Process** → **Crop** in the menu bar). This is necessary because the algorithm strives to reach the desired binder amount for each sub-segment and will try to add binder in the empty domain. Alternatively, the amount of binder might be set to zero for these segments.

The **Number of Rows** defines the number of Z-segments. To change the number of segments, change the **Number of Rows** to the number of segments desired.

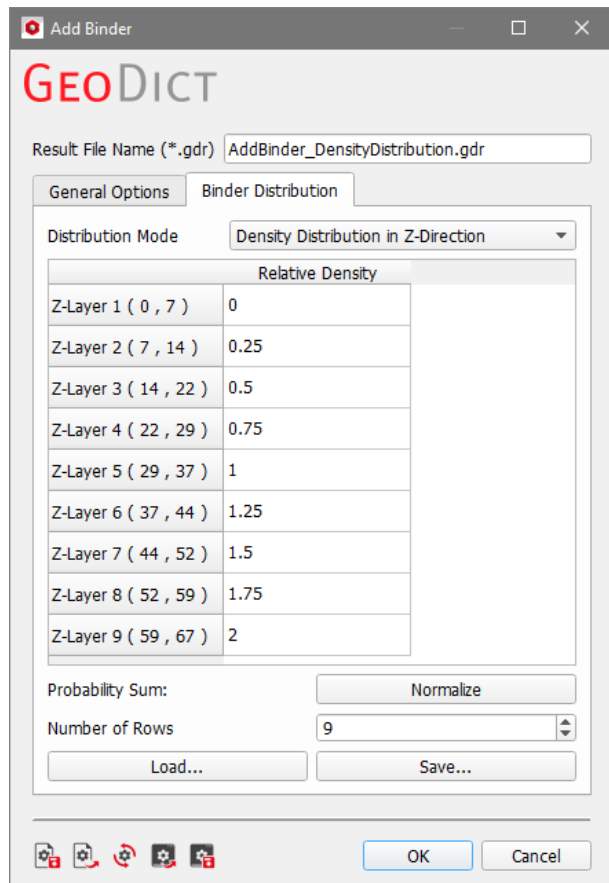

Material Information:
 ID 00: Pore [invis.]
 ID 01: Solid
 ID 02: Binder

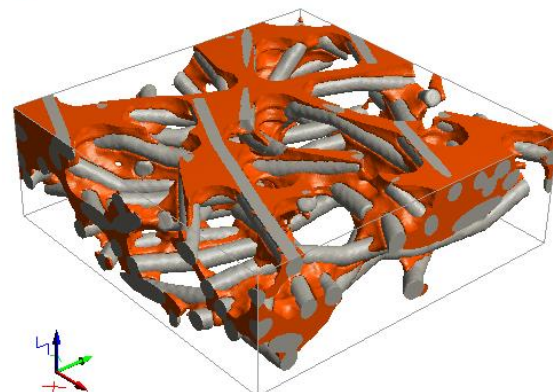

In each section the binder is generated separately according to the rules defined in the **General Options** Tab. The **Added Solid Volume Percentage / (%)** is scaled with the normalized **Relative Density** given in the table of **Binder Distribution**.

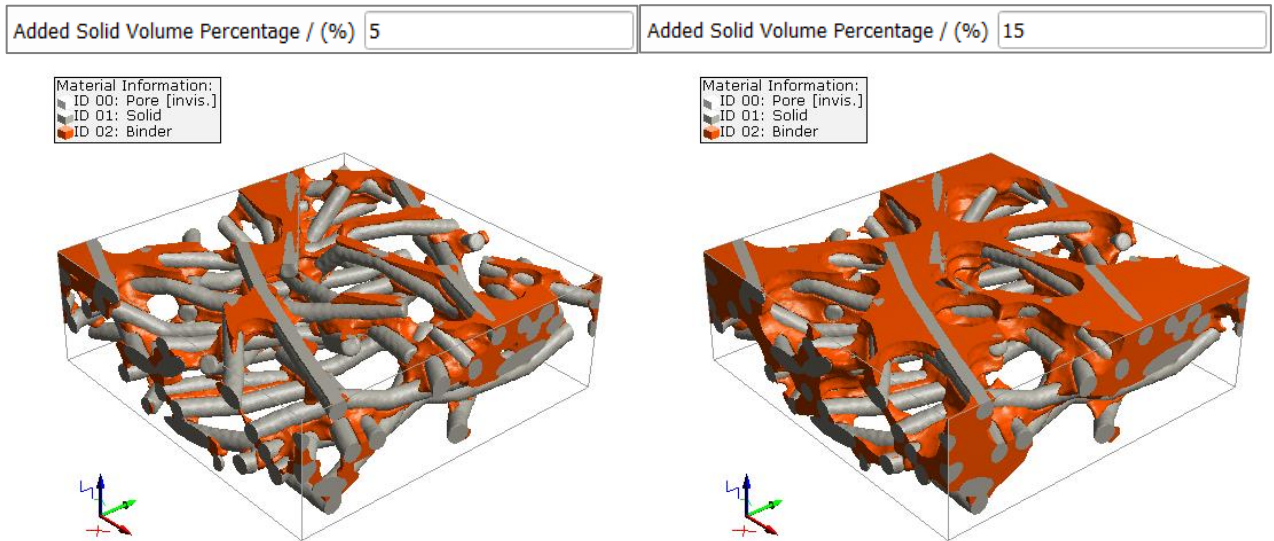

The **Binder Distribution** can be entered in form of a ratio in the **Relative Density** table.

In the images below, three different segments are clearly discernible with a binder distribution according to the relative values given in the table.

Here, 90% of the binder is distributed in the Z-layers 0-22.

0% of the binder is distributed in the Z-layers 22-44.

10 % of the binder is distributed in the Z-layers 44-67.



Clicking the **Normalize** button ensures the Relative Density values sum up to one.

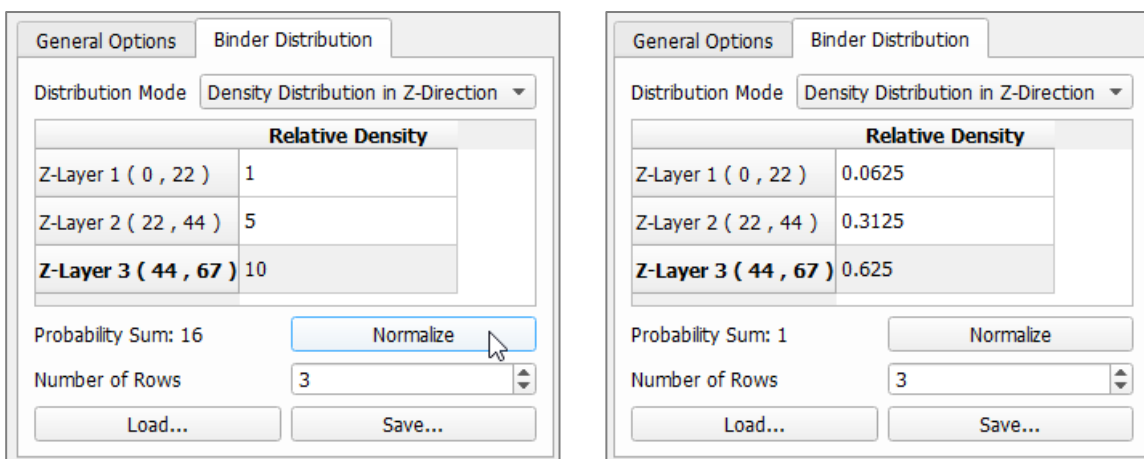

Now, the image shows the result of adding binder according to the normalized distribution:

6.25% of the binder is distributed in the Z-layers 0-22.

31.25% of the binder is distributed in the Z-layers 22-44.

62.5% of the binder is distributed in the Z-layers 44-67.



With the Buttons **Load...** and **Save...** the Distribution can be loaded/saved as text file which can be opened with other software as e.g. Microsoft Excel.

The parameters entered in the **Add Binder** dialog box can be saved into *.gps (GeoDict Project Settings) files and/or loaded from them. Remember to restore and reset your (or GeoDict's) default values through the icons at the bottom of the dialog box when needed and/or before every ProcessGeo-Add Binder run. Resting the mouse pointer over an icon shows a tooltip explaining the icon's function.



ADD FILLER

Fillers are materials added during papermaking to influence the properties of the paper (e.g. dry strength, optical properties, surface smoothness and printability), or to reduce the production costs. Ground or precipitated calcium carbonate (GCC, PCC)

is a commonly used filler. Other widely used fillers are china clay (kaolin), titanium dioxide, and talc.

Select **Add Filler** from the pull-down menu and click the **Options' Edit...** button to select parameters for the addition of filler.

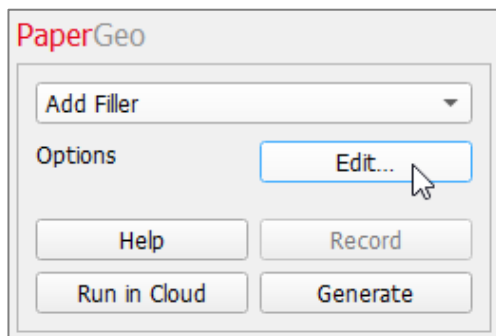

With **Add Filler**, spherical particles are added to coat the complete structure currently in memory (**Attached to Fiber**) or a single material ID from the structure can be selected and replaced by the filler particles (**Center in Material ID**).

Attached to Fiber attaches the spherical particles to all objects present in the structure currently in memory. There is no choice of a specific Material ID to be coated. In other words, the whole structure is coated with the filler.

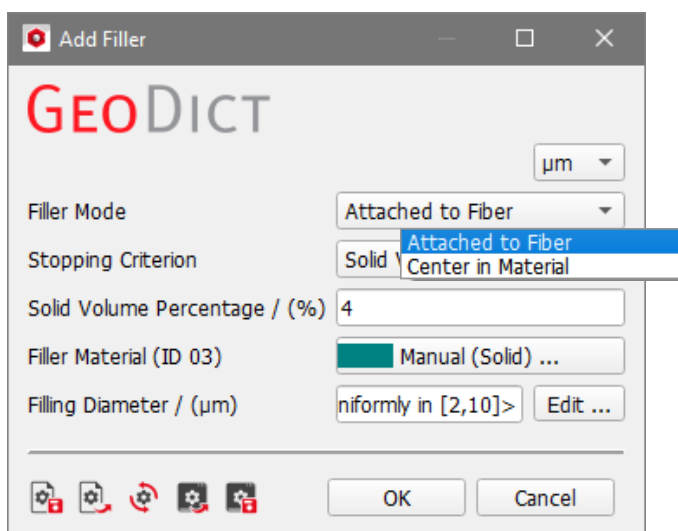

Center in Material ID replaces the selected material with filler particles in the form of spheres.

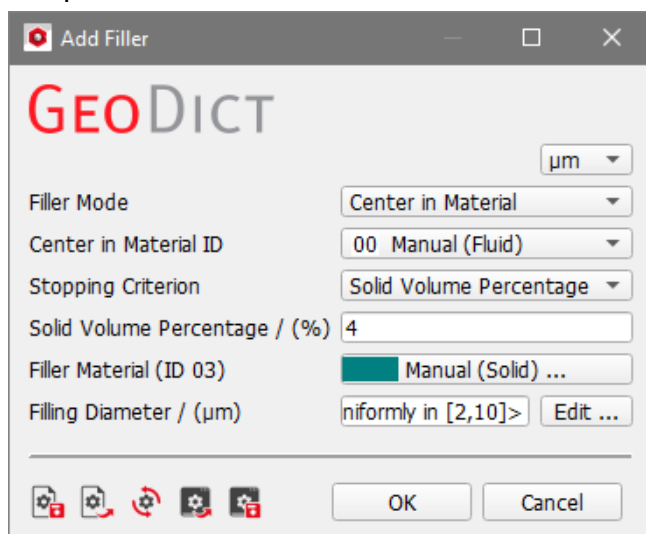

The Material ID of the objects in which to center the spherical particles can be selected from the **Center in Material ID** pull-down menu. Even the pore space filled with a fluid or solid can be selected to be filled.

This option is useful when the filler is to be added only in selected places, for example with the combination of an **Add Binder** and an **Add Filler** step.

As seen in pages [60ff.](#) (for the addition of binder), a **Stopping Criterion** must be selected to end the addition of filler. The possible stopping criteria are **Grammage** and **Solid Volume Percentage**. Both available criteria define the amount of filler to be added, either by its volume (**Solid Volume Percentage**) or by its weight (**Grammage**).

The **Filler Material** can be selected from the **GeoDict** or the user's material database by clicking the button. The filler material is assigned to the next available Material ID, but its color (as well as the color of fibers and binder) can be changed by selecting, in the Menu bar, **Settings** → **Color & Visibility Settings** dialog.

As an example of adding filler in the two modes, we use a structure with two types of synthetic fibers and added binder to observe the effect of adding filler particles as spheres of between 2 μm and 10 μm diameter:

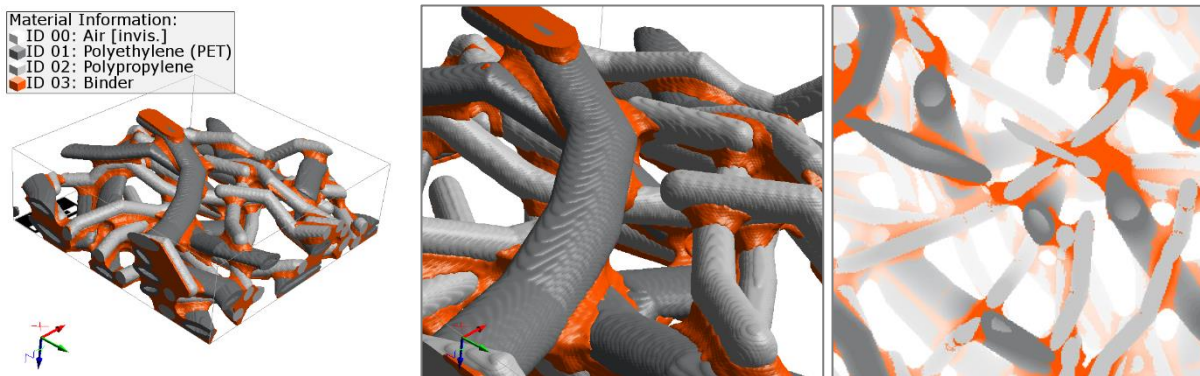

- Select **Attached to Fiber** to coat the surface of all materials present (including fibers with Material ID 01 and Material ID 02, in dark grey and light grey) and binder (Material ID 03, in orange).

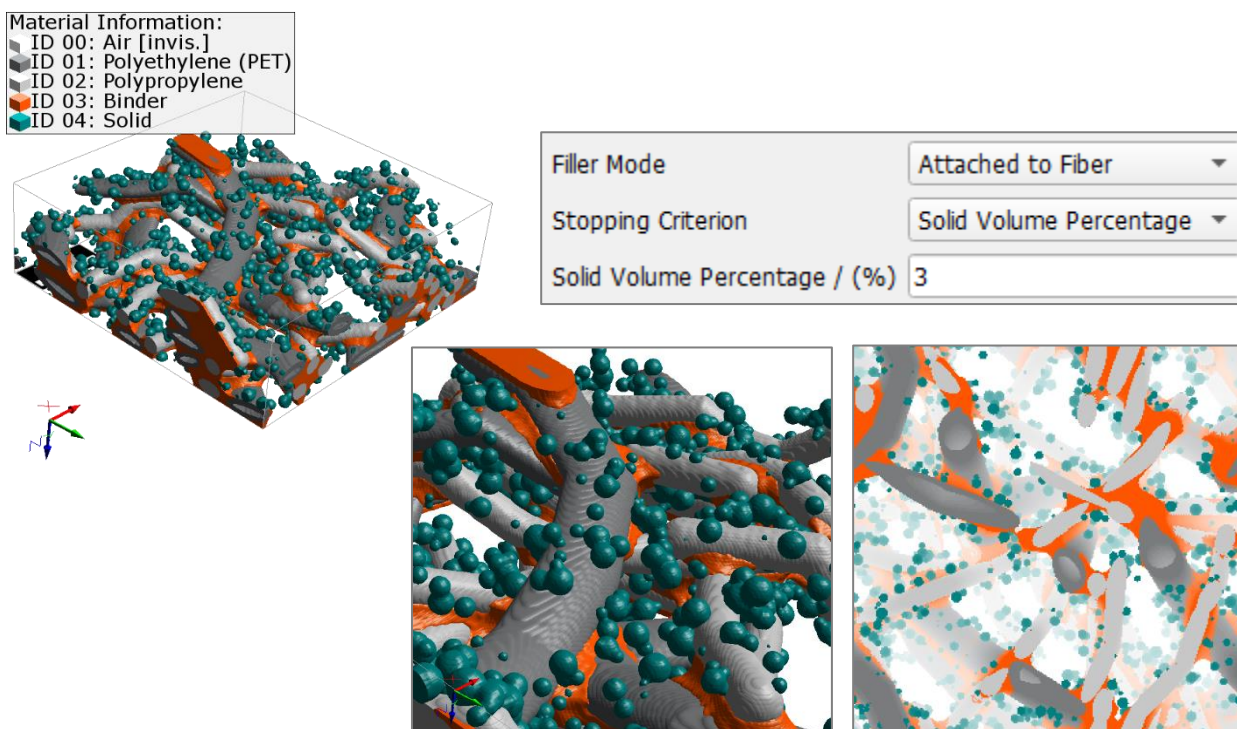

- Select **Center in Material ID** and choose the Material ID 03 (which here was the binder, shown in orange) to completely replace this material with filler.

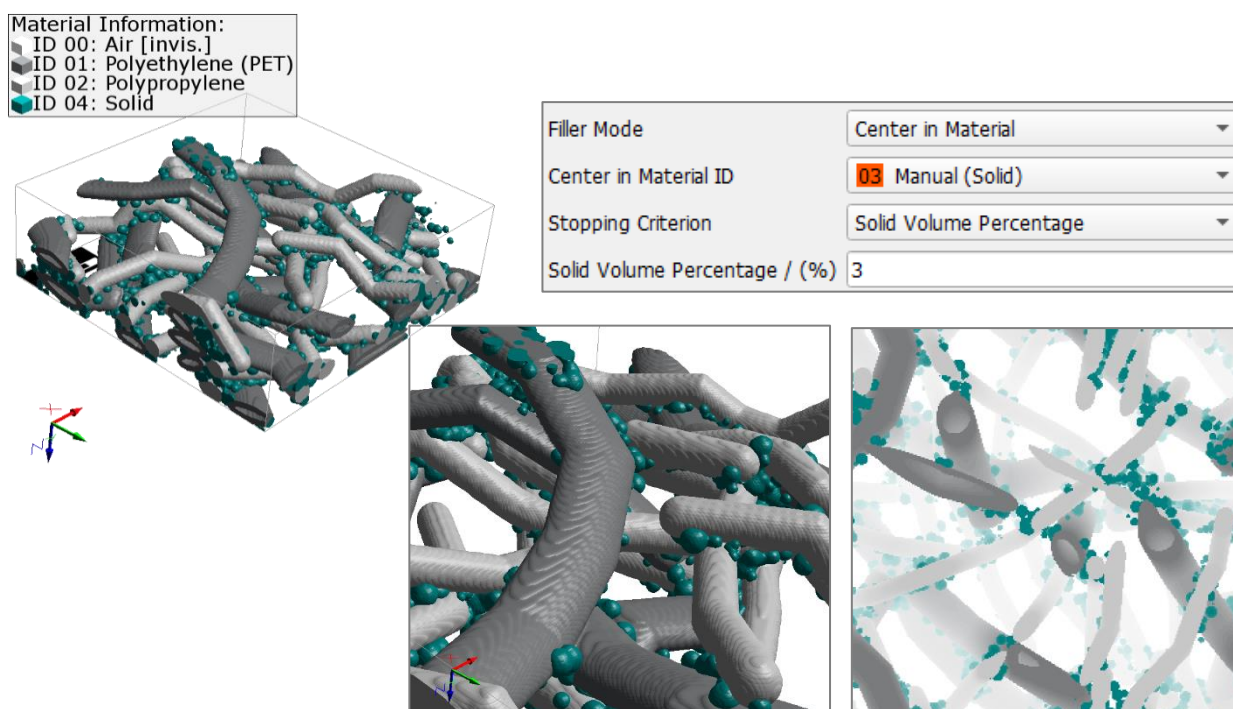

With **Center in Material ID**, keep in mind that the SVP of the filler must not be (much) higher than the SVP of the material to be replaced. Otherwise, the stopping criterion might be impossible to reach, and the addition of filler ends with an error message.

Here, the SVP of the material to be replaced (binder, ID 03) is approximately 5%, so the SVP of filler should not exceed 5%.

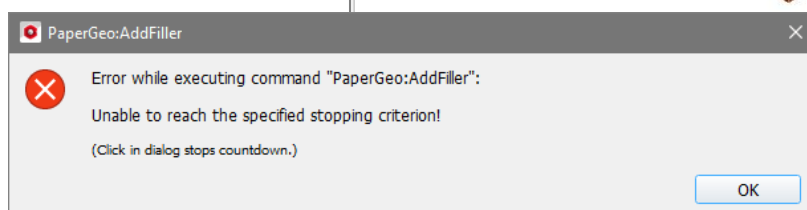
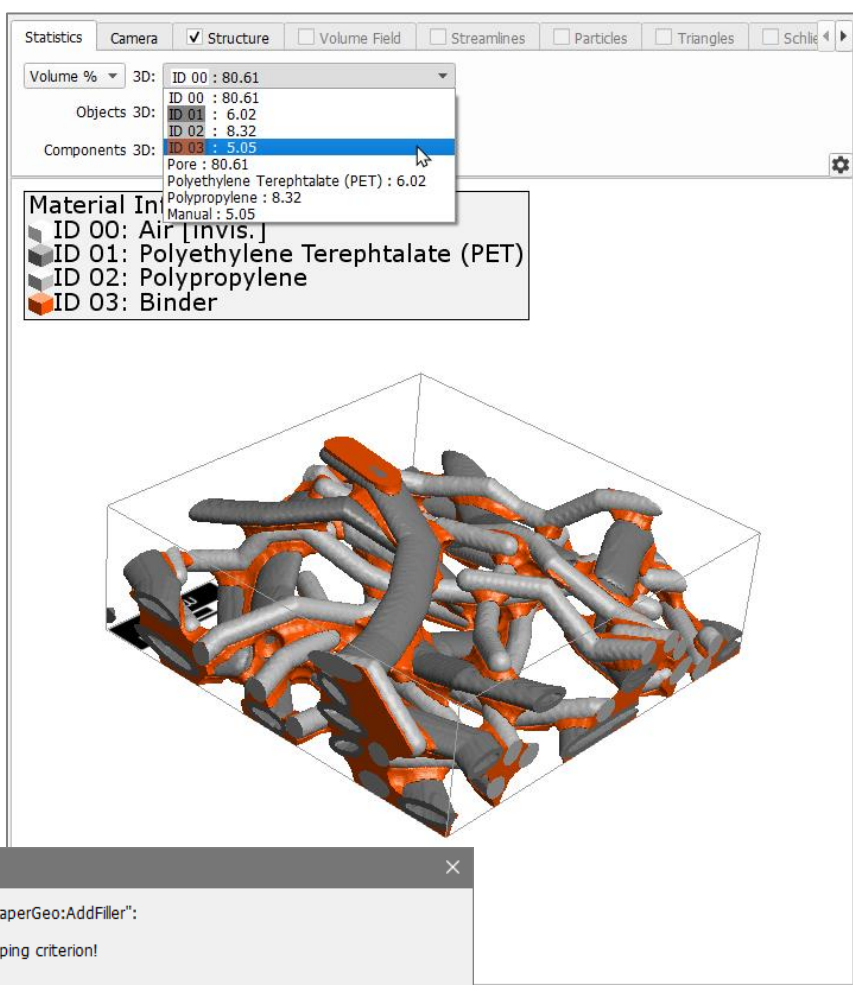

Observe the effect of adding 2% and 5% filler to replace the binder in the paper structure, and how this is reflected in the volume percentages of all components of the structure

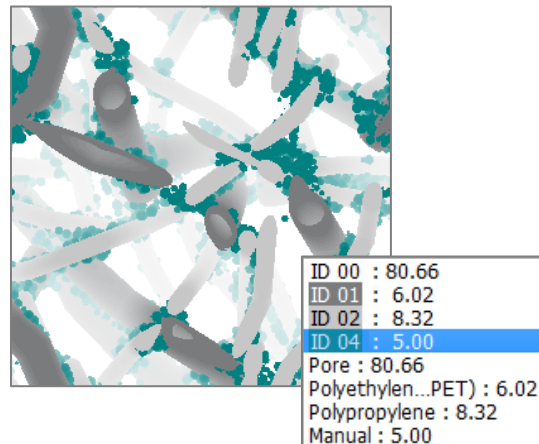
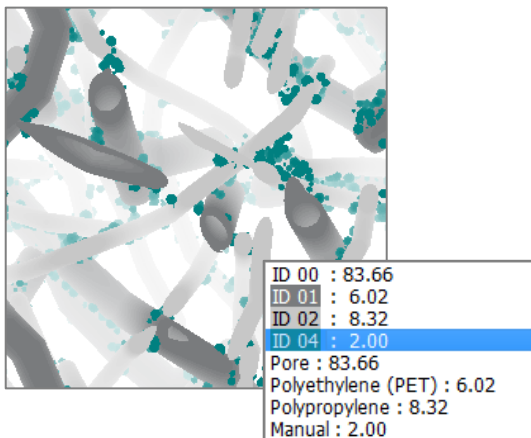
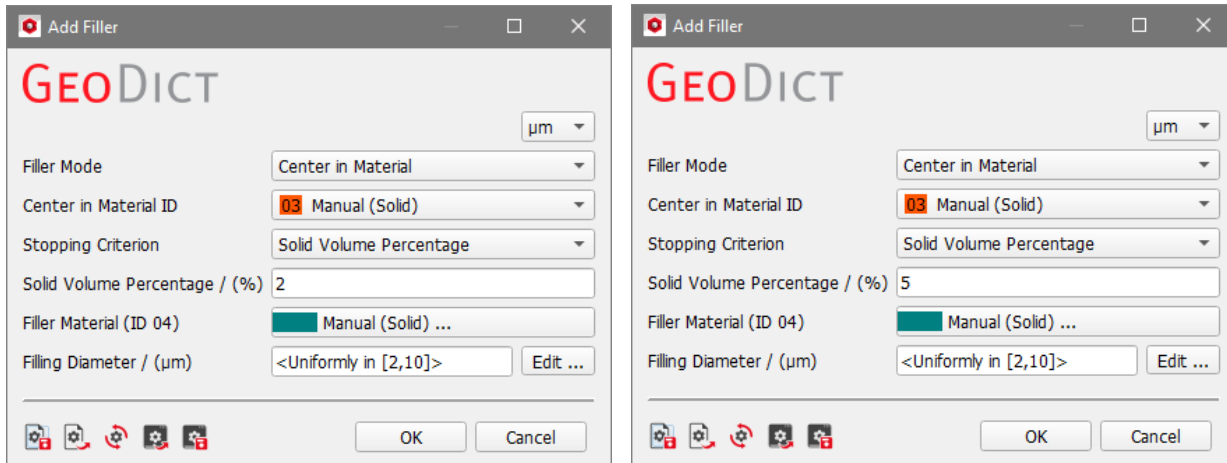

For **Grammage**, the **Filler Density [g/cm³]** defines the specific density of the filler material in g/cm³.

When **Manual** or **Undefined** are selected as **Filler Material**, the density of the filler is not automatically taken from the **GeoDict** database, and the user must enter it manually (**Filler Density**). If this filler material is regularly used, it can be saved in the material database. For further information, please consider the [Material Database handbook](#) of this User Guide.

For example, as the specific density of PCC is about 2.7-2.9 g/cm³ (2700-2900 kg/m³) enter the corresponding value for **Filler Density** in **PaperGeo**.

For some materials from the database, the **Temperature** must be defined, as density changes according to the temperature.

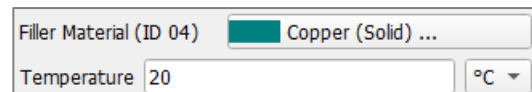

Observe the effect of adding a light (i.e. 1 g/cm³), and a dense filler (i.e. 3 g/cm³) while keeping the **Grammage** of the filler at 5 g/m². Here, the filler is added through **Attached to Fiber**. A larger amount of filler is added to the fiber-binder structure using the lighter filler.

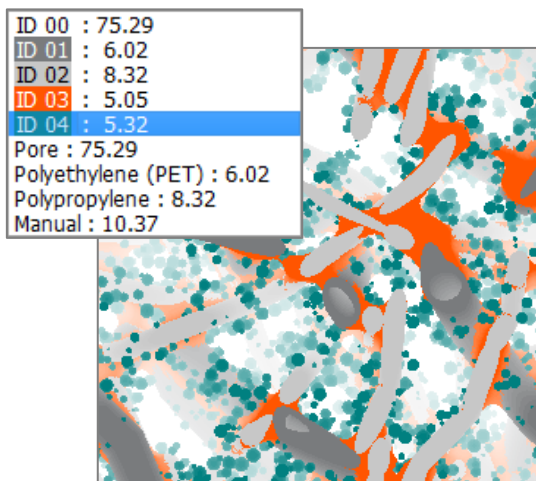

Filler Mode	Attached to Fiber	▼
Stopping Criterion	Grammage	▼
Grammage / (g/m ²)	5	
Filler Material (ID 04)	Manual (Solid) ...	
Filler Density / (g/cm ³)	1	
Filling Diameter / (μm)	<Uniformly in [2,10]>	Edit ...

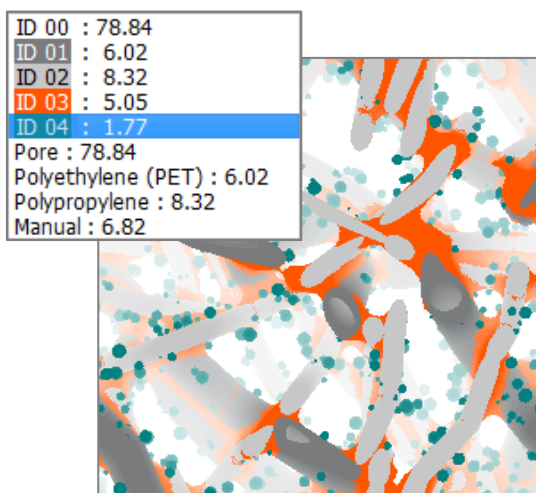

Filler Mode	Attached to Fiber	▼
Stopping Criterion	Grammage	▼
Grammage / (g/m ²)	5	
Filler Material (ID 04)	Manual (Solid) ...	
Filler Density / (g/cm ³)	3	
Filling Diameter / (μm)	<Uniformly in [2,10]>	Edit ...

The **Filling Diameter** of the spherical particles can be set after clicking the **Edit...** button. The diameter of the particles can be constant or follow one of several distributions (**Uniformly in interval**, **Gaussian**, user-defined **Probability Distribution**, or **Logarithmic-Normal**). See pages [27ff.](#)

Observe the filler particles when the diameter changes uniformly in interval, between a minimum of 2 μm and a maximum of 15 μm.

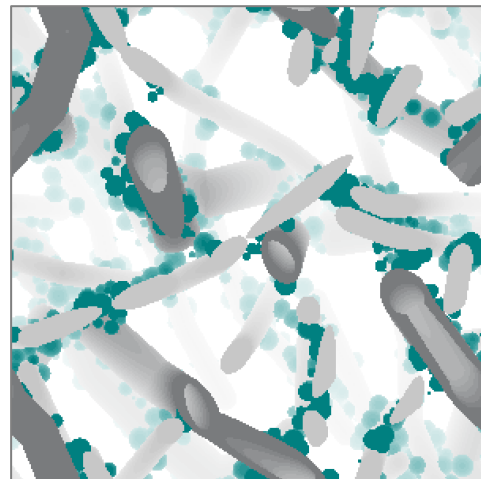
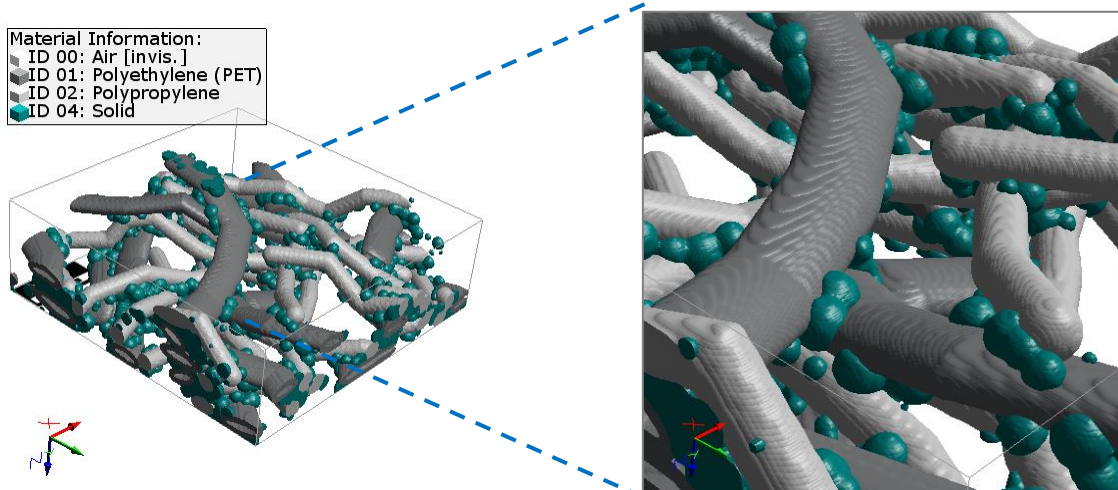

Technical
documentation:

Janine Hilden
Sebastian Rief
Barbara Planas

MATH
2 MARKET

Math2Market GmbH
Richard-Wagner-Str. 1, 67655 Kaiserslautern, Germany
www.geodict.com