

GRIDGEO

User Guide

GeoDict release 2024

Published: January 15, 2024

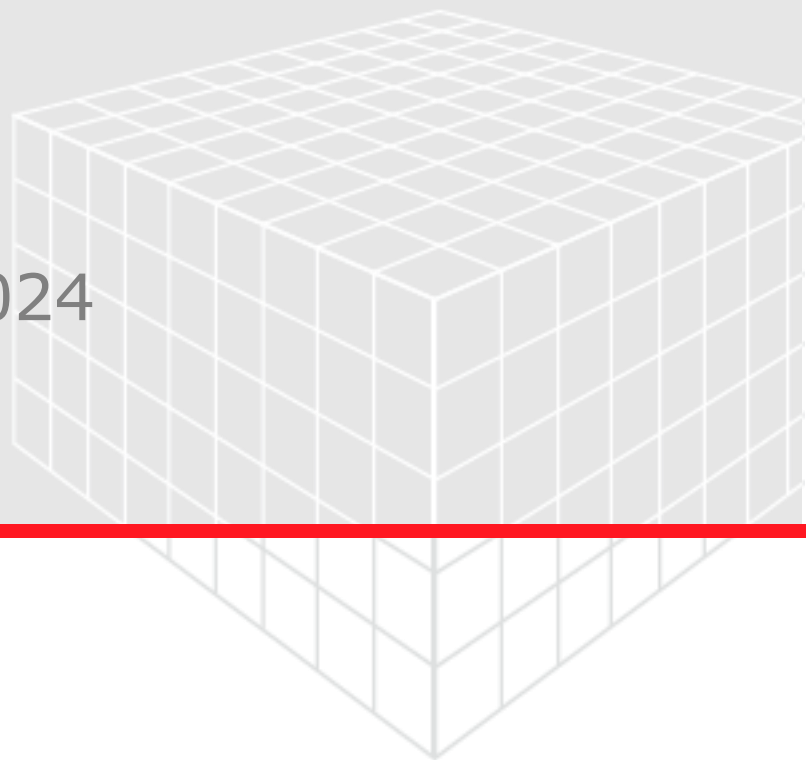

GEO DICT

<https://doi.org/10.30423/userguide.geodict>

© Math2Market GmbH 2024

Citation:

Anne Blumer, Barbara Planas. GeoDict 2024 User Guide. GridGeo handbook. Math2Market GmbH, Germany, doi.org/10.30423/userguide.geodict

All rights reserved. It is not permitted to reproduce the book or parts thereof in any form by photocopy, microfilm or other methods or to transfer it into a language suitable for machines, in particular data processing systems, without the express permission of the publisher. The same applies to the right of public reproduction.

The handbooks in the User Guide series of Math2Market GmbH can be obtained from:

Math2Market GmbH
Richard-Wagner-Strasse 1
67655 Kaiserslautern
Germany

Phone: +49 631 205 605 0
Fax: +49 631 205 605 99
Email: info@math2market.de
Web: www.math2market.de

GENERATING LATTICES IN 2D AND 3D	1
GRIDGEO SECTION	2
GRID OF SPHERES	3
Simple Cubic grid	4
Body-Centered Cubic grid	4
Face-Centered Cubic grid	5
Hexagonal grid	5
Relation between Sphere Diameter and Sphere Center Distance	5
Object Materials	6
Domain	7
GRID OF PARALLEL CYLINDERS	12
USER-DEFINED GRID	15
Basis settings in this GridGeo handbook	17
Grid Options – Rectangular Grid	18
Grid Options – Non-Rectangular Grid	20
Objects in Unit Cell	22
PERFORATED FOIL	25
Periodic Foil	26
Free Foil	29
GRID GEOAPPS	31
Strut-Based Lattices	32
Triply Periodic Minimal Surfaces (TMPS)	42
APPENDIX – RELATIONSHIP BETWEEN THE FACE-CENTERED CUBIC AND HEXAGONAL LATTICES	51

GENERATING LATTICES IN 2D AND 3D

Regular structures in the 2D-plane or in 3D space can be generated with **GridGeo**. In combination with other **GeoDict** modules, a wide range of application is possible, like e.g. structures for flow and filtration simulations, mechanical simulations, or benchmarking structures.

Five different options are available:

- **Grid of Spheres:** With this option, four common sphere lattices can be generated, those are the Simple Cubic, Body-Centered Cubic, Face-Centered Cubic and Hexagonal grids.
- **Grid of Parallel Cylinders:** Parallel cylinders are arranged in the plane.
- **User Defined Grid:** This is the most powerful option in **GridGeo**. Periodic arrangements of an arbitrary selection of objects can be generated in 3D, even with non-orthogonal basis vectors.
- **Perforated Foil:** Flat sheets with differently shaped holes can be generated.
- **Grid GeoApps:** Selection of predefined macros which create specific regular structures. The macros can be found in the installation folder.

Grid of Spheres

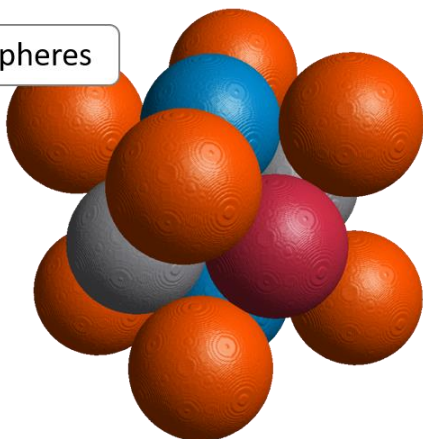

Grid of Parallel Cylinders

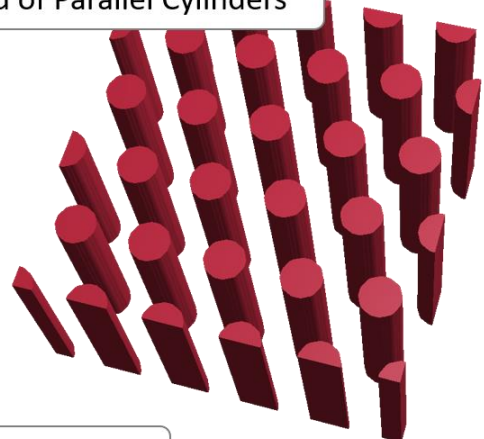

User Defined Grid

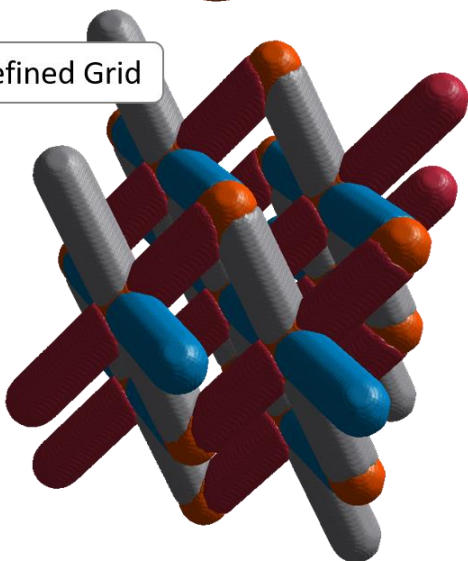

Perforated Foil

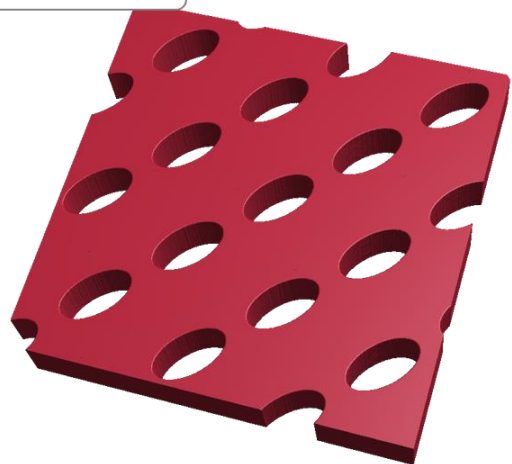

GRIDGEO SECTION

GridGeo opens when selecting **Model** → **GridGeo** in the menu bar.

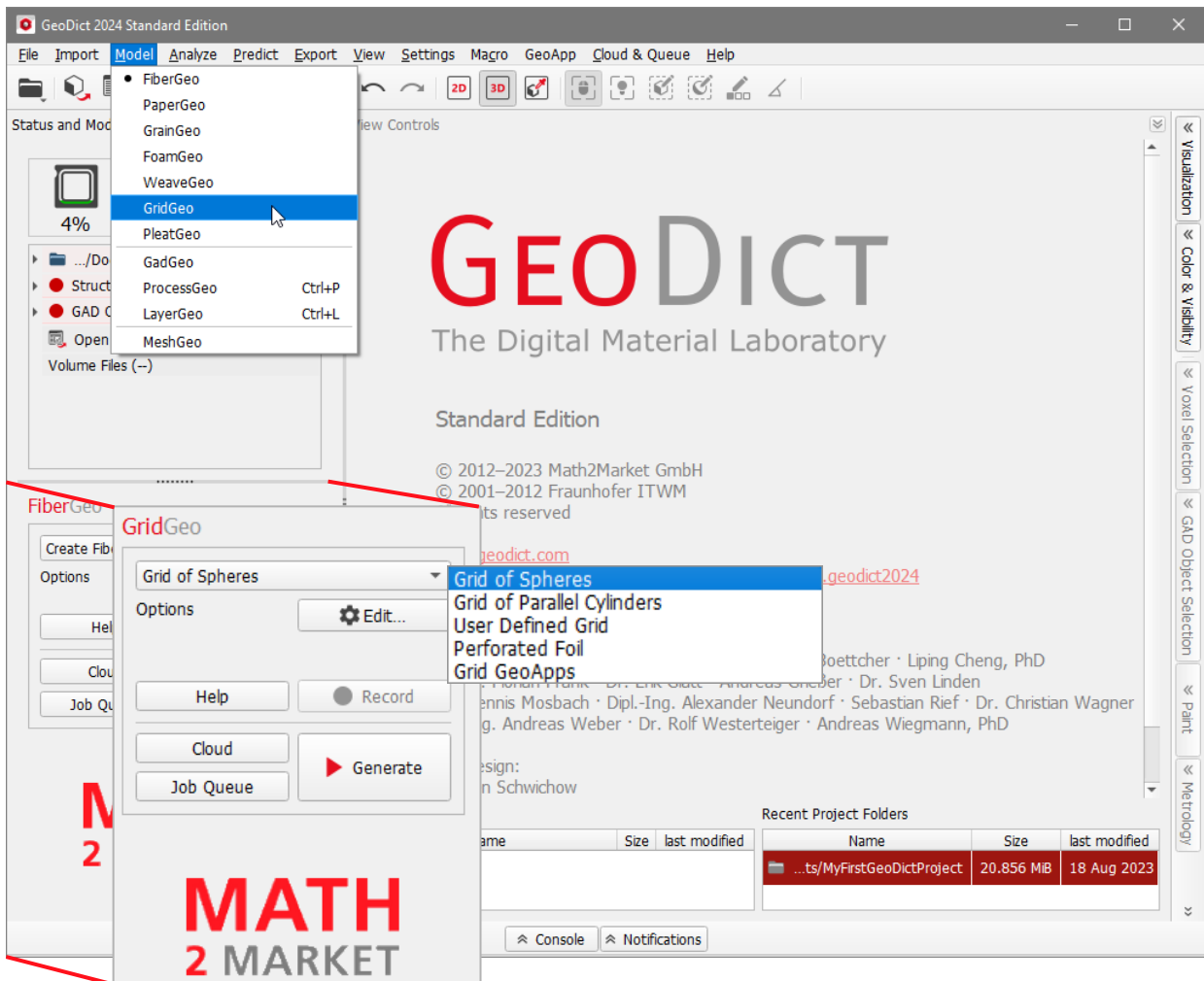

GridGeo is used to generate a **Grid of Spheres**, a **Grid of Parallel Cylinders**, or a **User Defined Grid**, or to generate a **Perforated Foil**. Additionally, two **Grid GeoApps** which allow to generate grid two predefined grid types are available.

The generated **Grid of Spheres** and **Grid of Parallel Cylinders** are regular arrangements of spherical and cylindrical structures, based on the entered parameters for these geometrical forms.

The **User Defined Grids** can be based on an arrangement of objects of any object type available in GeoDict.

The **Perforated Foils** are membrane-like structures with hole shapes that conform to the specified perforation parameters.

To generate a grid, or a perforated foil, enter the necessary parameters through the Options' **Edit...** button.

Clicking **Generate** at the bottom of the **GridGeo** section starts the program's generation run.

Macro files containing all steps of the grid generation process can be recorded and saved in the project folder when selecting **Macro** → **Start Macro Recording...** in the menu bar. When recording a macro, **Record** becomes active and **Generate** changes to **Generate & Record**.

Depending on the chosen grid model, a different **Options** dialog box opens when clicking the **Options' Edit...** button (**Sphere Grid Options**, **Cylinder Grid Options** and **User Defined Grid Options**). Several parameters recur in these dialog boxes, while others are only available for a certain grid type.

GRID OF SPHERES

A customized **Result File Name (*.gdr)** should be entered to differentiate the results of sets of **GridGeo** generations. The *.gdr result file is automatically placed inside the chosen project folder.

With **GridGeo-Grid of Spheres**, sphere lattices of the four most common types can be generated. These are:

- **Simple Cubic** lattice
- **Body-Centered Cubic** lattice
- **Face-Centered Cubic** lattice
- **Hexagonal** lattice.

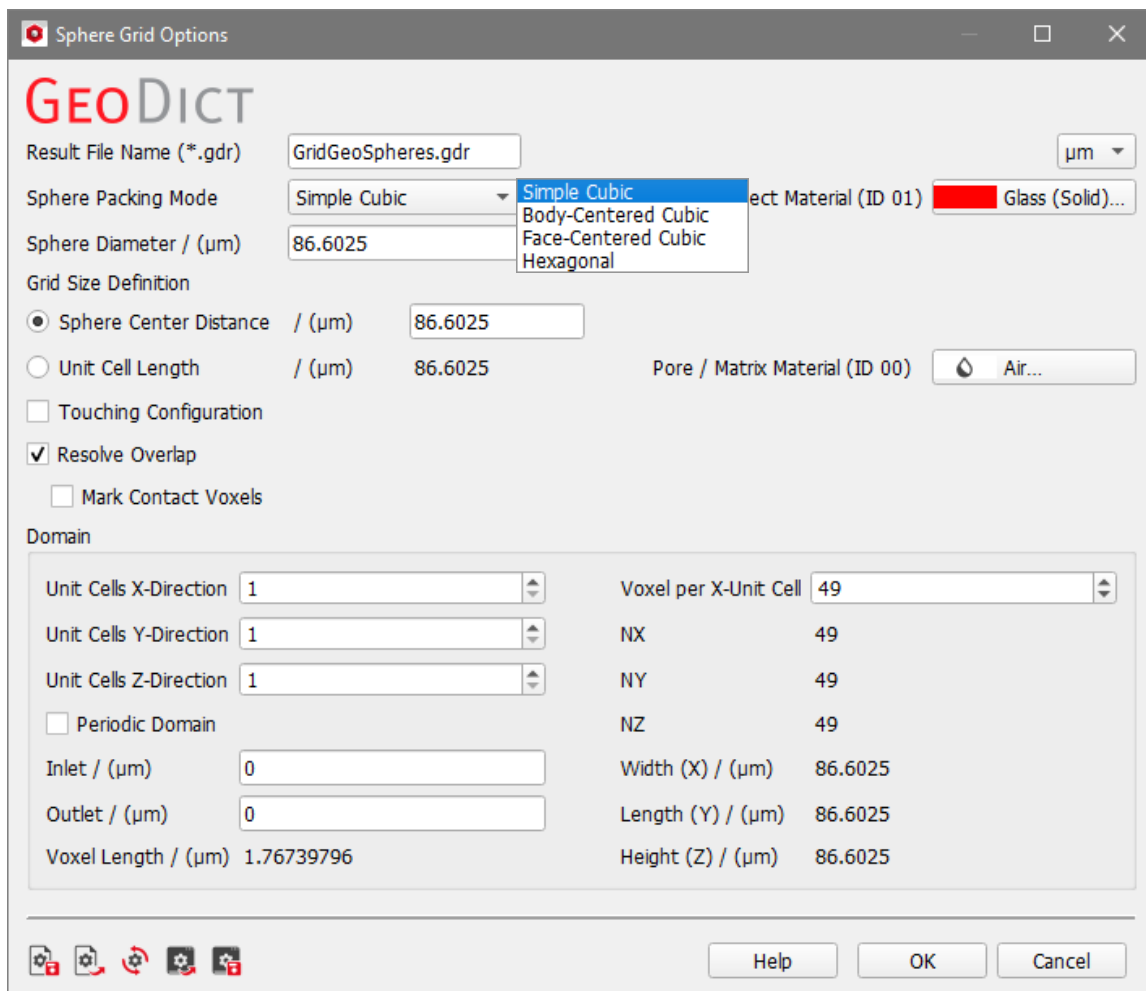
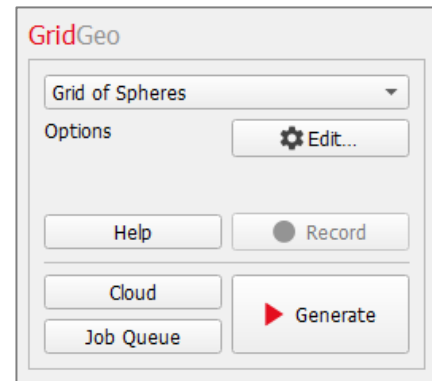

In the **Face-Centered Cubic** and the **Hexagonal** lattice, the highest possible packing density can be achieved. Those two lattices are closely related, more information about this relation can be found in the [Appendix](#).

In the **Sphere Grid Options** dialog, the lattice type is chosen under **Sphere Packing Mode**. The four available lattice types (Simple Cubic, Body-Centered Cubic, Face-Centered Cubic and Hexagonal) are explained below. The **Sphere Diameter** defines the diameter of the spheres in the grid and it is equal for all spheres.

There are two possibilities for the **Grid Size Definition**. One way is to define the **Sphere Center Distance**, which is the minimal distance between sphere centers in the grid. Alternatively, the **Unit Cell Length** can be chosen. The **Unit Cell Length** is the length of the longest side of the unit cell, its relation to the sphere center distance depends on the chosen lattice type (**Sphere Packing Mode**). Checking **Touching Configuration** sets the **Sphere Diameter** equal to the **Sphere Center Distance**, so that the spheres in the lattice touch perfectly.

The interaction of these parameters is explained in detail after the introduction of the different grid types. The unit cell is shown for every available grid. The left figure shows the packing, where the spheres are cut at the boundary of the unit cell domain. The right figure shows the packing with the whole spheres.

SIMPLE CUBIC GRID

In the **Simple Cubic** grid, the spheres are placed at the corners of the cubic unit cell. When the **Touching Configuration** is chosen, a packing density of $\frac{1}{6} \cdot \pi \approx 52.36\%$ is achieved and the sphere center distance equals the sphere diameter.

The unit cell length in the Simple Cubic grid is equal to the sphere center distance.

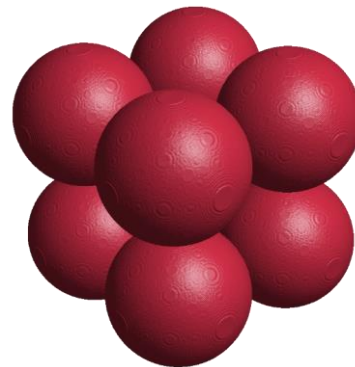
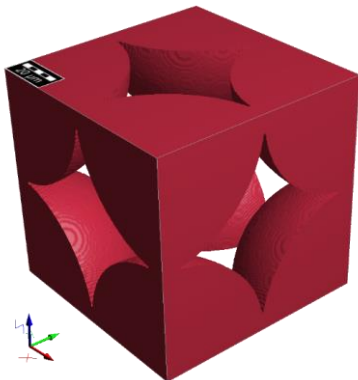

BODY-CENTERED CUBIC GRID

In the **Body-Centered Cubic** grid, one sphere is in the middle of the unit cell and one at every corner. A packing density of $\frac{\sqrt{3}}{8} \cdot \pi \approx 68.02\%$ is achieved. The unit cell length in the Body-Centered Cubic grid is $\frac{2}{\sqrt{3}}$ times the sphere center distance.

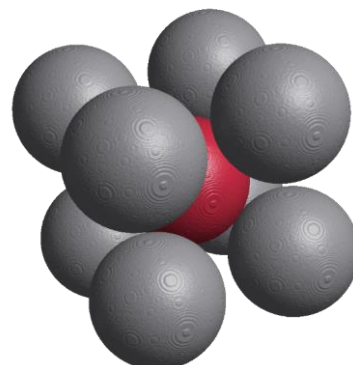
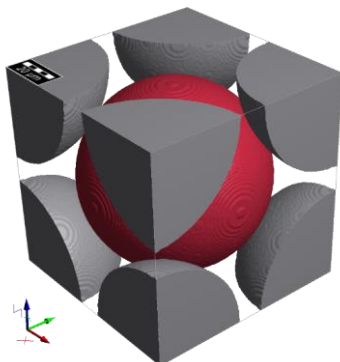

FACE-CENTERED CUBIC GRID

In the **Face-Centered Cubic** grid, one sphere is located at each corner of the unit cell, and one at each face of the cube. The achieved packing density is the highest possible value for all types of grids with equal diameter spheres, $\frac{1}{3\sqrt{2}} \cdot \pi \approx 74.05\%$.

The Face-Centered Cubic grid, the closest to the hexagonal grid, can also be regarded as a stacking of hexagonally arranged layers of spheres. For more information about this relation, see the [Appendix](#).

The unit cell length in the Face-Centered Cubic grid is $\sqrt{2}$ times the sphere center distance.

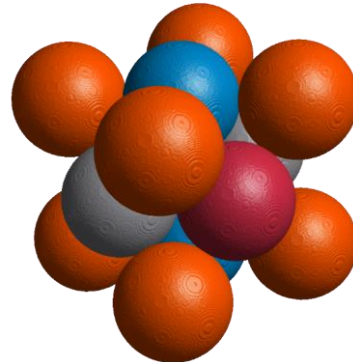
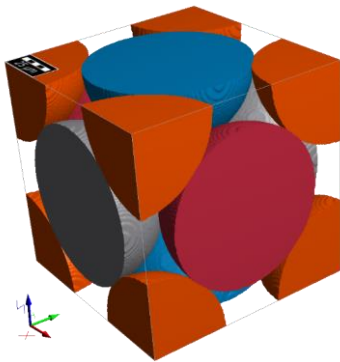

HEXAGONAL GRID

In the **Hexagonal** grid, layers of hexagonally arranged spheres are stacked on top of each other. In the figure on the right-hand side, the first layer (A) consists of the red and grey spheres, while the second (B) consists of the blue and orange spheres. Each layer fits perfectly in the "gaps" of the preceding layer and vice versa.

The packing density in the hexagonal grid is the same $\frac{1}{3\sqrt{2}} \cdot \pi \approx 74.05\%$ as in the Face-Centered Cubic grid.

The unit cell length in the Hexagonal grid is $\frac{2}{3} \cdot \sqrt{6}$ times the sphere center distance.

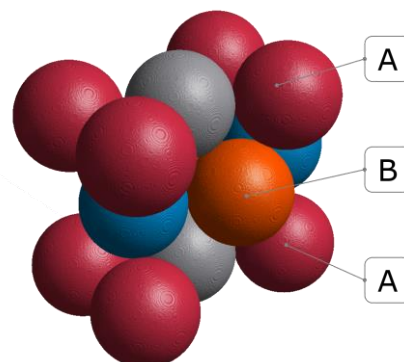
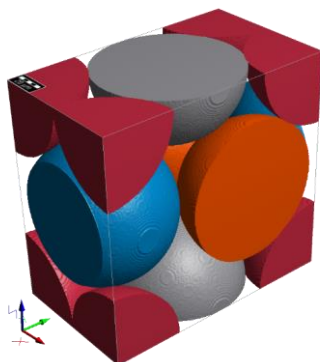

RELATION BETWEEN SPHERE DIAMETER AND SPHERE CENTER DISTANCE

The minimal distance between spheres in the selected grid occurs when the **Sphere Diameter** is chosen equal to the **Sphere Center Distance**. In this case, the touching configuration is realized: spheres touch and no overlaps occur. These two parameters should always be chosen in combination.

Generating lattices in 2D and in 3D

In the next figure, their relation is illustrated:

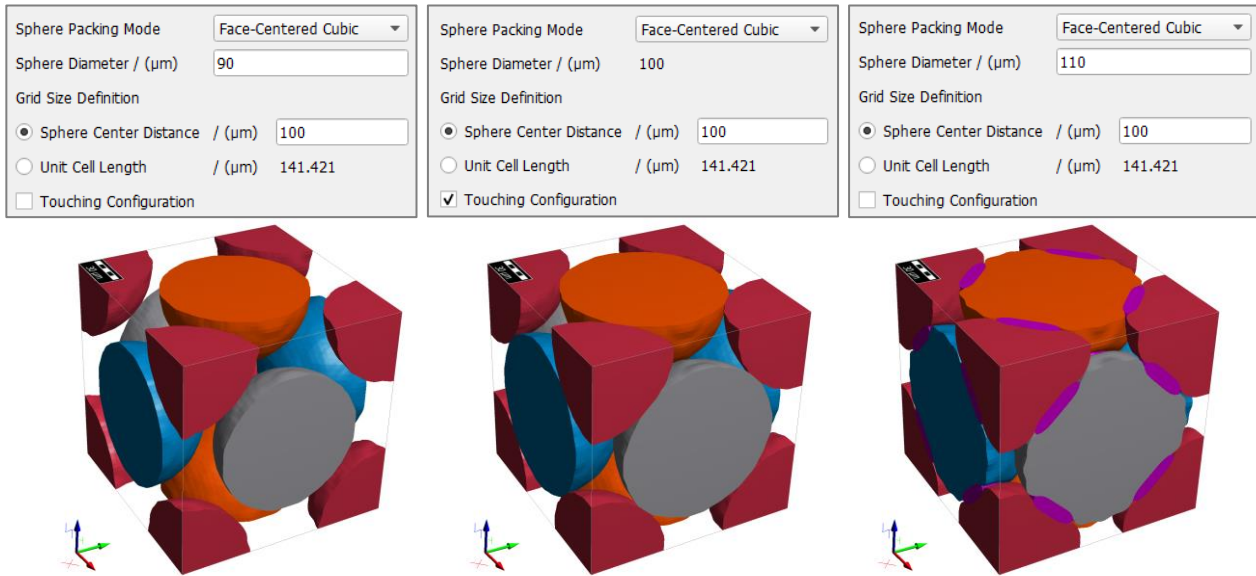

Choosing the sphere diameter smaller than the sphere center distance leads to empty space between all spheres in the grid and choosing it larger leads to overlapping spheres.

OBJECT MATERIALS

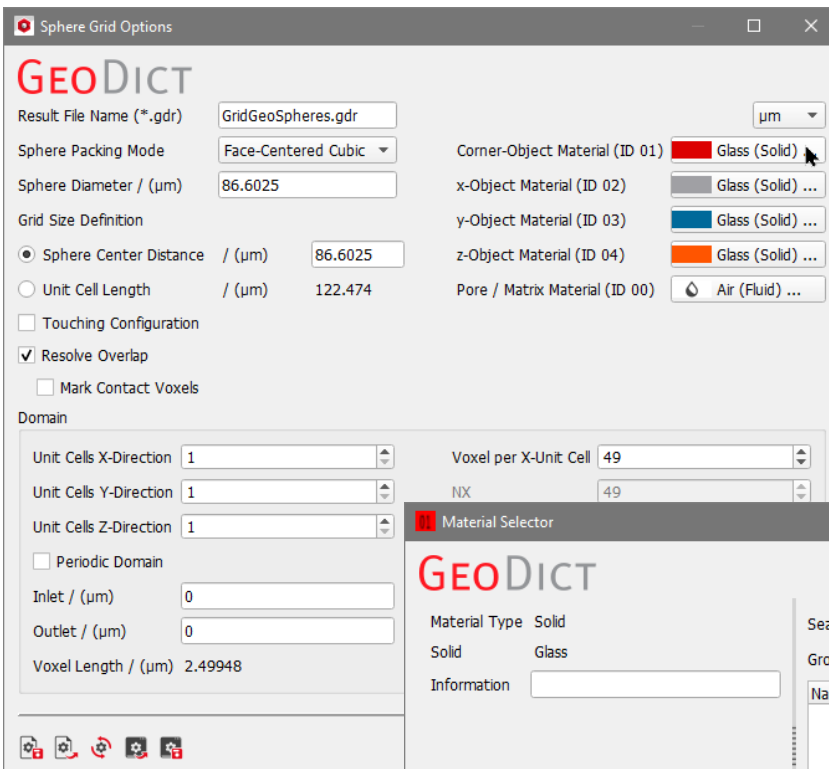

The materials for the spheres and the pore space in the grid can be chosen according to the user's needs.

Clicking on the materials buttons at the top right of the window opens the **Material Selector** dialog, which provides access to the **GeoDict** Material Database.

Overlap Behavior

If the sphere diameter is chosen larger than the sphere center distance, overlap between the spheres occurs. The intersection volume of the spheres is assigned to the overlap material, which can be chosen by the user.

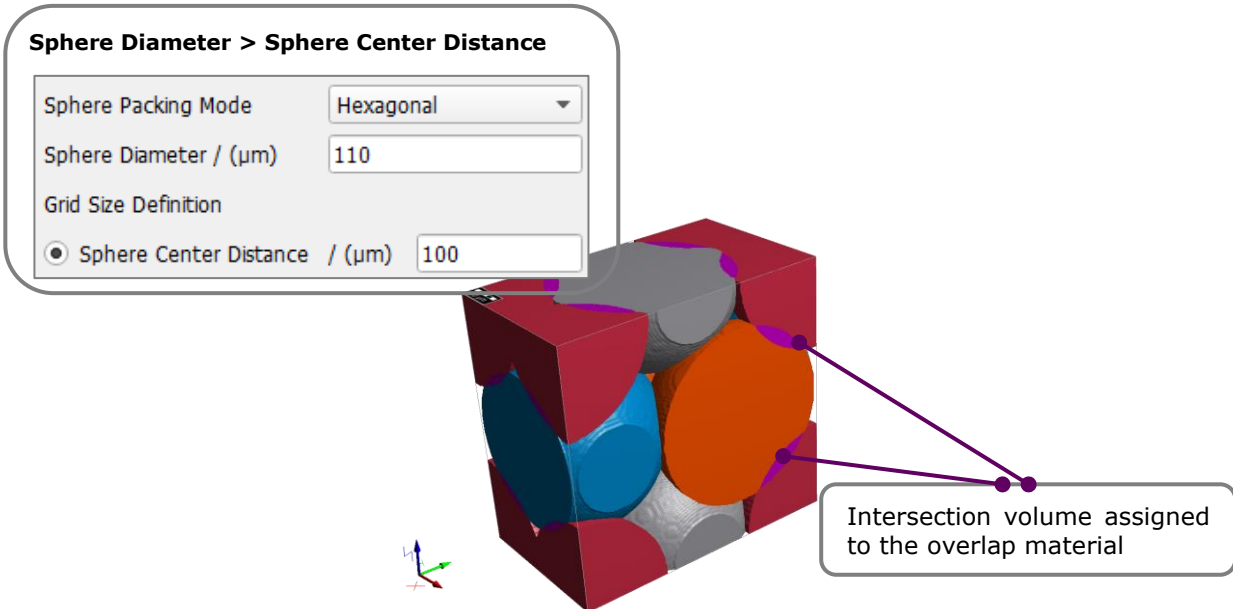

However, the user can decide what happens with overlap regions. By checking **Resolve Overlap** the watershed algorithm is used for the undecided overlap voxels in a post-processing step, in which each overlap voxel is assigned to one specific object. Checking this option requires more memory and a slightly longer runtime.



Additionally, check **Mark Contact Voxels** to label the contact voxels with a separate material ID, to which a different material can be assigned.

DOMAIN

In the **Domain** panel, the general properties of the generated grid are defined.

The **Unit Cells X-, Y- and Z-Direction** define the number of repetitions of the unit cell in space. The domain can be chosen to be **Periodic**.

With **Inlet** and **Outlet**, empty space can be added at the top and bottom of the structure. This might be useful for flow simulations.

The number of **Voxel per X-Unit Cell** sets the resolution of the structure.

Generating lattices in 2D and in 3D

Domain			
Unit Cells X-Direction	1	Voxel per X-Unit Cell	49
Unit Cells Y-Direction	1	NX	49
Unit Cells Z-Direction	1	NY	49
<input type="checkbox"/> Periodic Domain		NZ	49
Inlet / (μm)	0	Width (X) / (μm)	86.6025
Outlet / (μm)	0	Length (Y) / (μm)	86.6025
Voxel Length / (μm)	1.76739796	Height (Z) / (μm)	86.6025

UNIT CELLS X-, Y-, AND Z-DIRECTION

Observe the effect of setting the number of unit cells for the different directions.

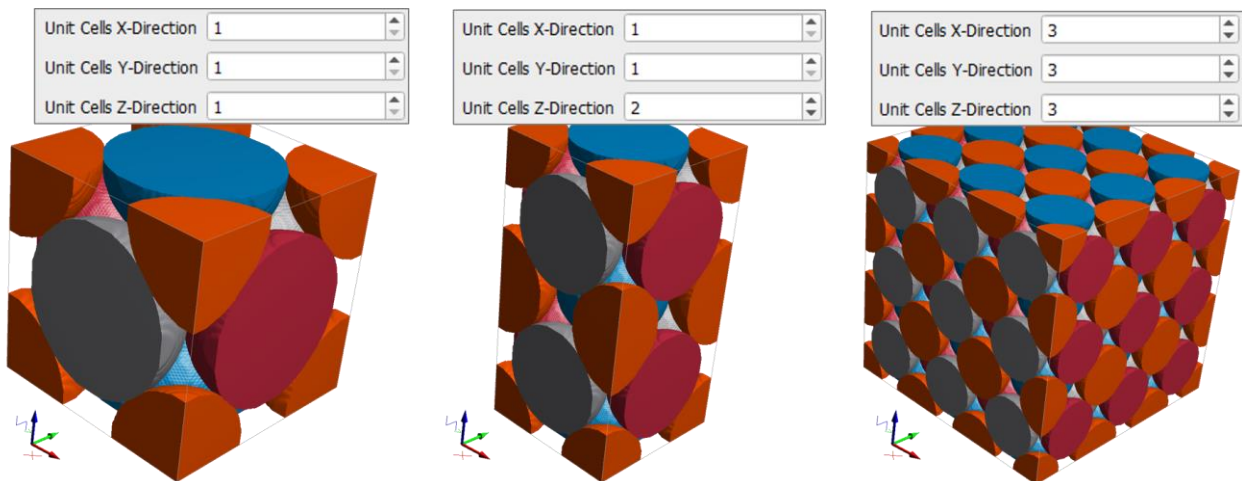

INLET AND OUTLET

With the **Inlet** and **Outlet** option, additional space can be added at the bottom and top of the structure (in Z-Direction).

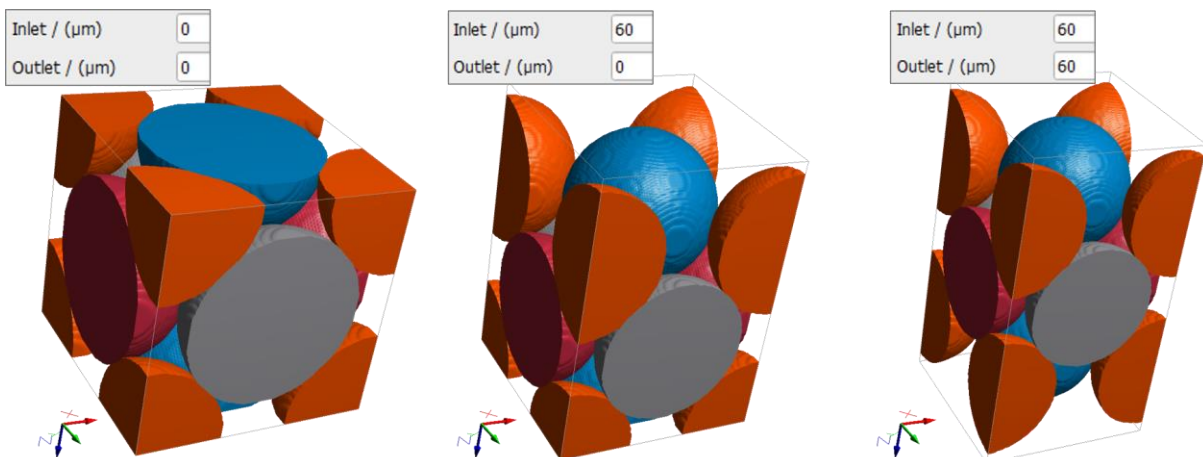

VOXEL PER X-UNIT CELL AND VOXEL LENGTH

The **Voxel Length** itself is not editable. It depends on the chosen **Sphere Packing Mode** and the value for **Voxel per X-Unit Cell**. The packing mode together with the sphere diameter define the size of the unit cell.

The unit cell of the Simple Cubic, Body-Centered Cubic and Face-Centered Cubic grid types are cubic, while the unit cell for the Hexagonal grid is a cuboid. Therefore, the number of voxels per Unit Cell in X-direction also sets the number of voxels for the other two directions, and it determines the **Voxel Length**.

For hexagonal grids, it is not possible to achieve the exact side lengths of the (theoretical) cuboid unit cell with cubic voxels. Therefore, **GridGeo** approximates the unit cell in the given resolution:

Voxel per X-Unit Cell 10		Voxel per X-Unit Cell 100		Voxel per X-Unit Cell 1000	
NX	10	NX	100	NX	1000
NY	17	NY	173	NY	1732
NZ	16	NZ	163	NZ	1633
Width (X) / (μm)	10	Width (X) / (μm)	10	Width (X) / (μm)	10
Length (Y) / (μm)	17	Length (Y) / (μm)	17.3	Length (Y) / (μm)	17.32
Height (Z) / (μm)	16	Height (Z) / (μm)	16.3	Height (Z) / (μm)	16.33

This leads to a slightly different unit cell size in each resolution (as shown in the screenshots above), and therefore the resulting positions of the spheres will depend on the selected resolution. Furthermore, it is possible that in some cases the spheres may slightly overlap, even for cases where a **Touching Configuration** was selected.

To evaluate the effect of choosing the number of Voxels per X-Unit Cell on the resolution of the structure, it is important that the 3D-structure mode is *NOT* set to **Smooth** (select **View** → **3D Structure Renderer** → **Box**).

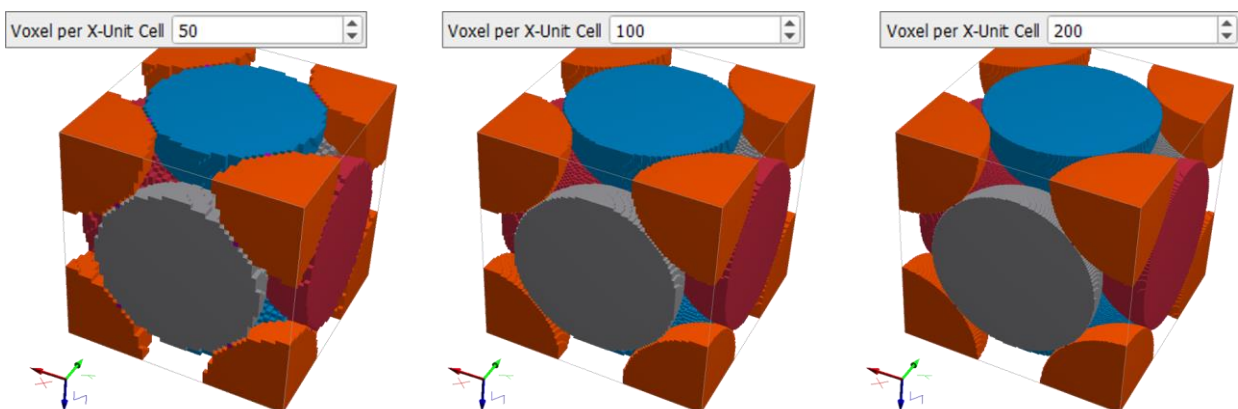

PERIODICITY OF THE UNIT CELL

Sphere grids can be generated in a periodic domain in **GridGeo** when **Periodic Domain** is checked. This means that a sphere cut by the domain boundary will enter the domain periodically on the opposite domain boundary. Hence, if a sphere is cut by the boundary all parts (the sphere is cut into) are visible. If this option is not

Generating lattices in 2D and in 3D

checked the grid domain is not periodic. This difference is explained in more detail below with the example of a Simple Cubic grid.

When a unit cell of the Simple Cubic grid is generated when **Periodic Domain** is checked, it looks like 8 cut spheres are located at the corners of the unit cell. In reality, there is only one sphere in the unit cell. This sphere is repeated periodically and, therefore, appears again at the opposite sides of the cell.

This can easily be examined by looking at the structure information panel located to the left of the GeoDict GUI: There is only one GAD object in the structure.

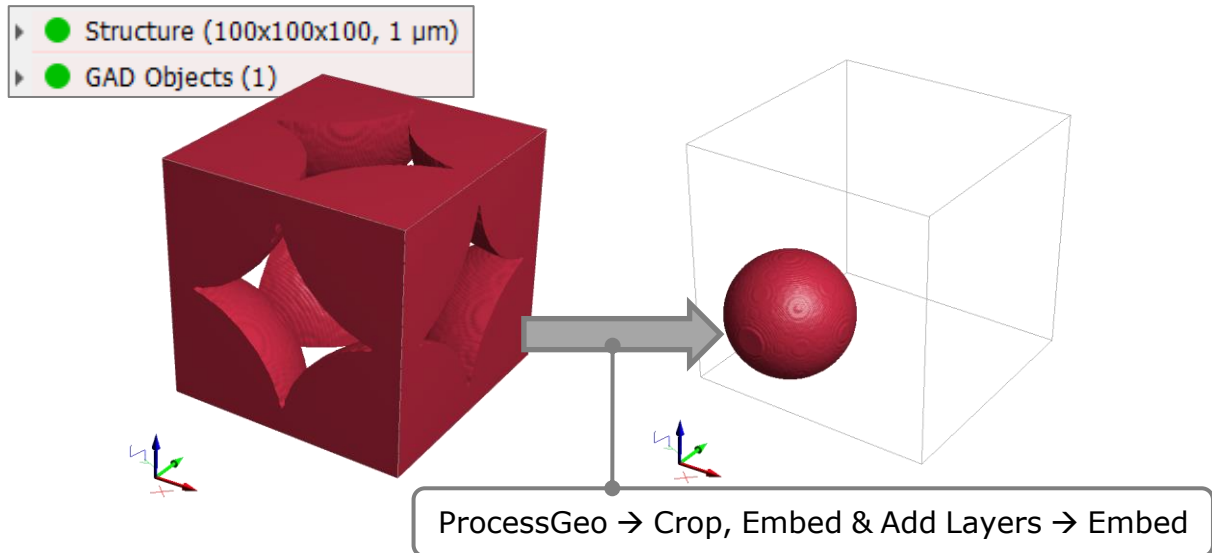

When embedding the structure with **Model → ProcessGeo → Crop, Embed & Add Layers → Embed** in a larger domain (and choosing Embed Analytic Objects), only that one sphere appears in the domain.

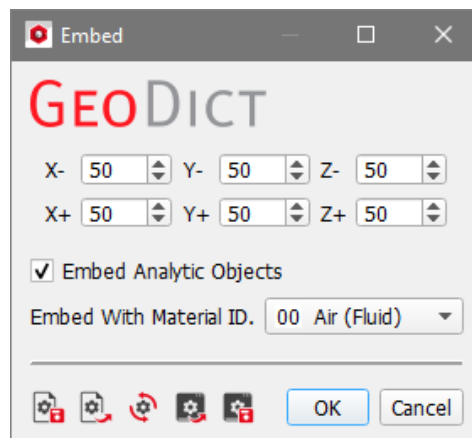

When one sphere for every corner should appear in the embedded structure, an additional step must be conducted. By choosing **Model → GadGeo → Algorithms → Expose Periodic Objects**, one complete sphere is added to the structure for every partial sphere in the original structure.

This can be examined in the structure information panel. Now 8 objects exist in the structure (see the figure below). When this structure is now embedded (Model → ProcessGeo → Crop, Embed & Add Layers → Embed), 8 complete spheres appear in the final structure. The same result can directly be realized when **Periodic Domain** is not checked.

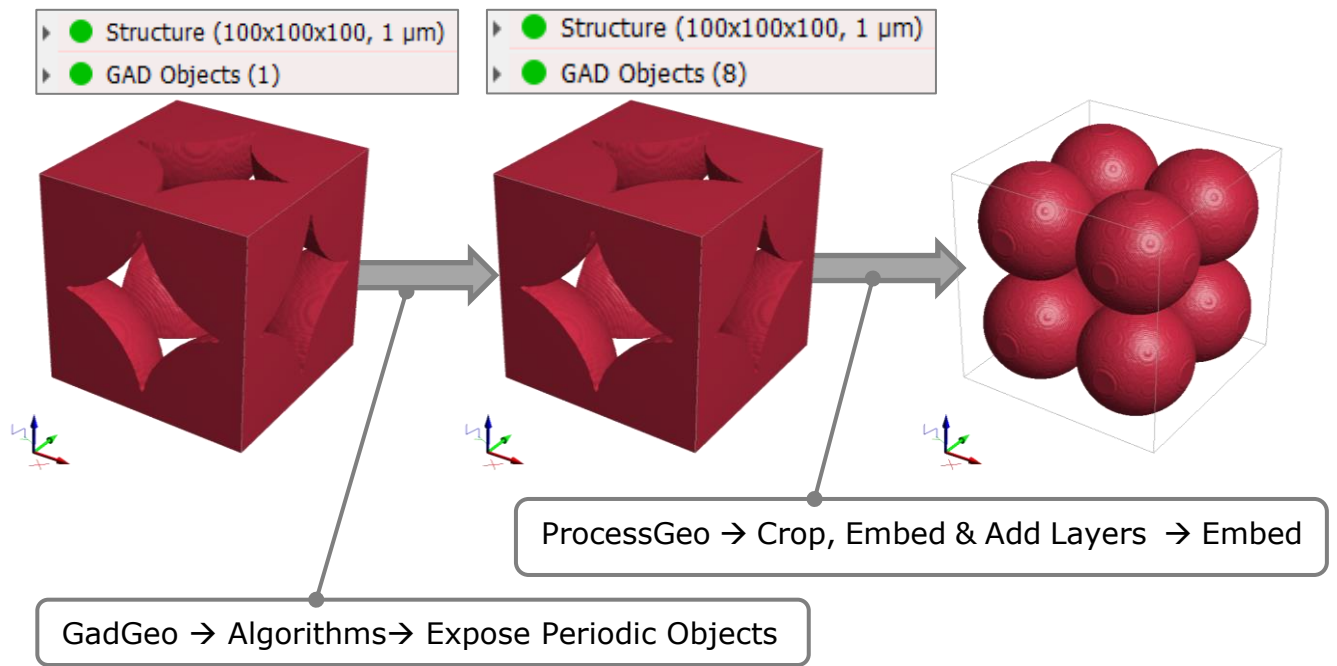

GRID OF PARALLEL CYLINDERS

To generate a grid of cylinders, select **Grid of Parallel Cylinders** from the pull-down menu in the **GridGeo** section. Click the grid Options' **Edit...** button and set the parameters in the opening **Cylinder Grid Options** dialog box.

A customized **Result File Name (*.gdr)** should be entered to differentiate the results of sets of **GridGeo** generations. The *.gdr result file ensuing from the generation is automatically placed inside the chosen project folder.

The available units (**m**, **mm**, **μm**, **nm**, and **Voxel**) are selectable from the pull-down menu at the top of the dialog.

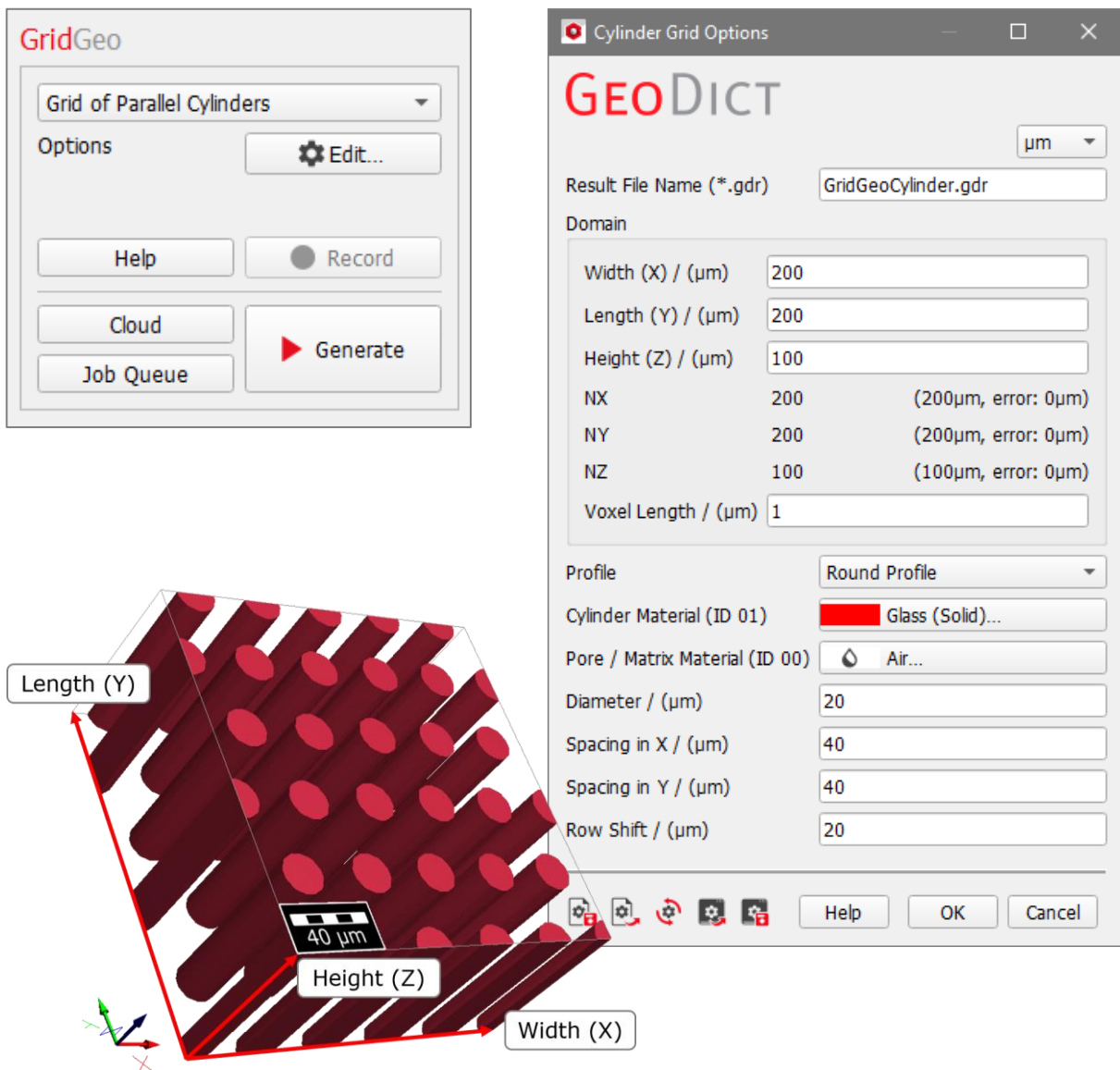

Width (X), **Length (Y)**, and **Height (Z)** define the size of the domain. **NX**, **NY**, and **NZ** are the number of voxels of the grid in the X, Y, and Z axes, they depend on the size of the domain and on the **Voxel Length**. **Voxel Length** sets the size of a voxel in the selected unit and, therefore, the resolution of the structure.

The **Cylinder Material (ID 01)** and the **Pore / Matrix Material (ID 00)** can be chosen from the **GeoDict** material database.

Choose the cylinder **Profile** from the pull-down menu: **Round Profile**, **Square Profile**, or **Angular Profile**. The available parameters differ depending on the chosen profile type: For the round profile, the **Diameter** of the cylinders must be set, for the square profile, the **Side Length** and the **Orientation Angle** must be chosen and for the angular profile, the **Diameter**, **Orientation Angle**, and the **Number of Edges** must be defined.

The effect of changing the **Profile** type can be observed in the figure below.

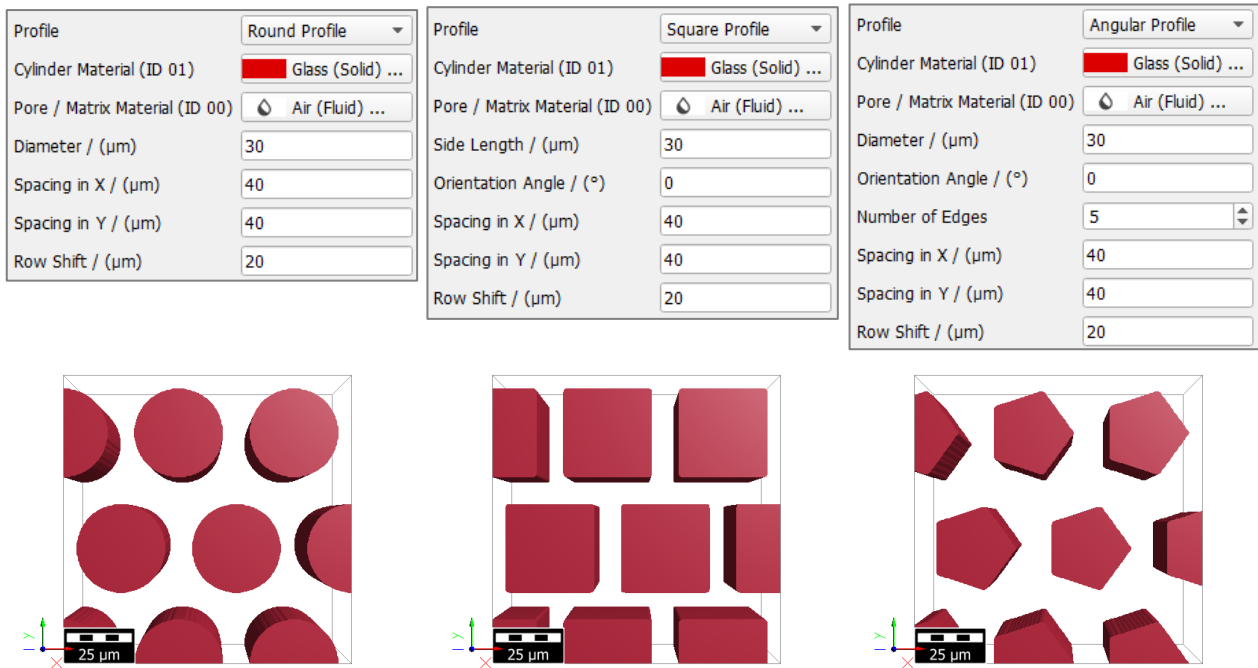

The **Orientation Angle** determines the rotation of the profile in the X-Y-plane. Depending on the combination of parameters, overlapping structures can be generated.

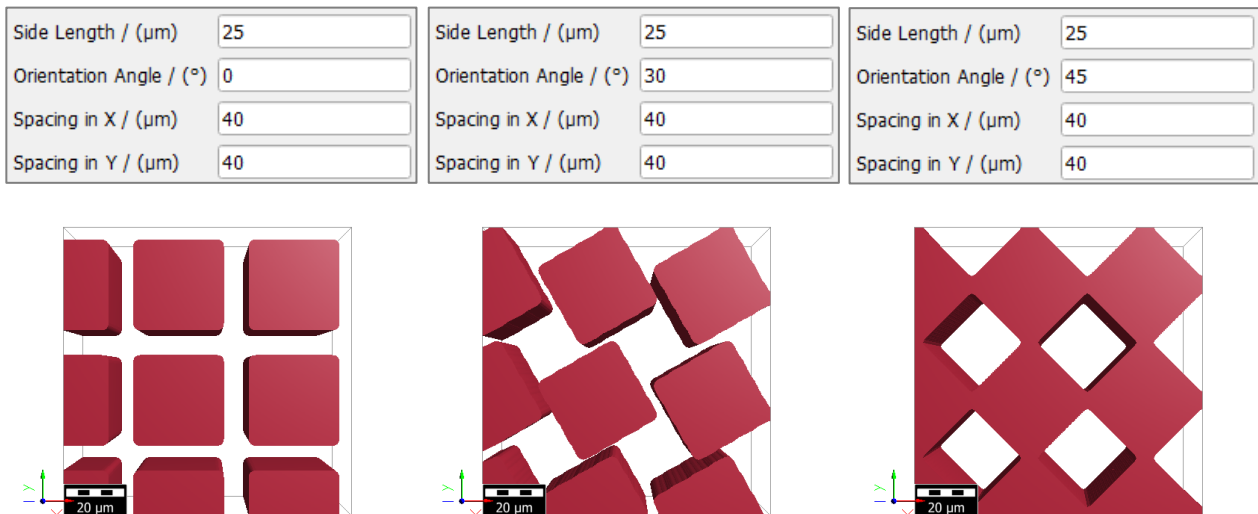

Spacing in X and **Spacing in Y** determine the distance between the centers of the cylinders in the given direction.

Generating lattices in 2D and in 3D

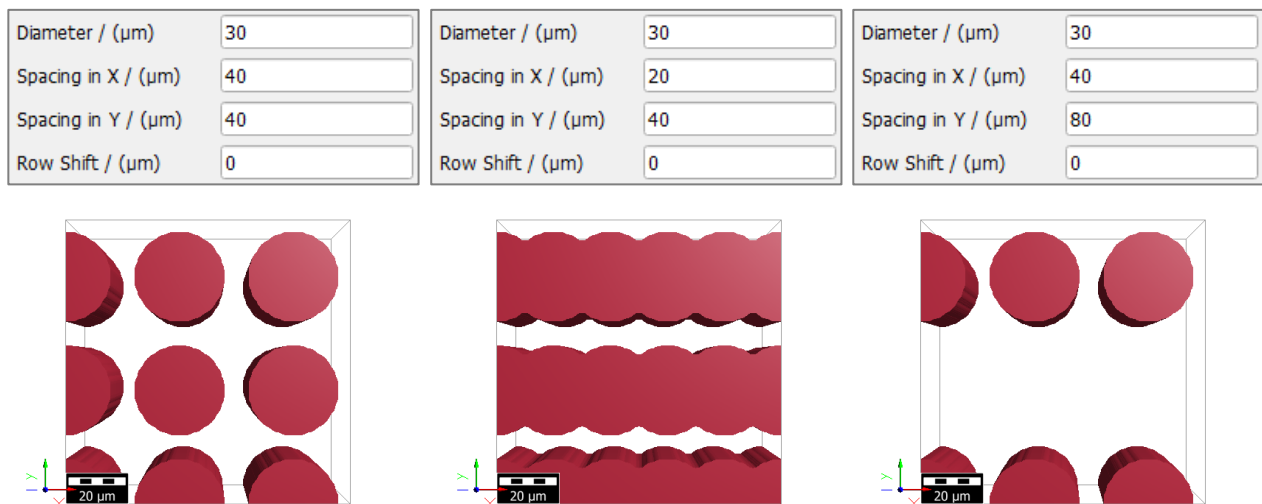

Row Shift defines the spatial displacement in X-direction between rows of cylinders in the XY-plane.

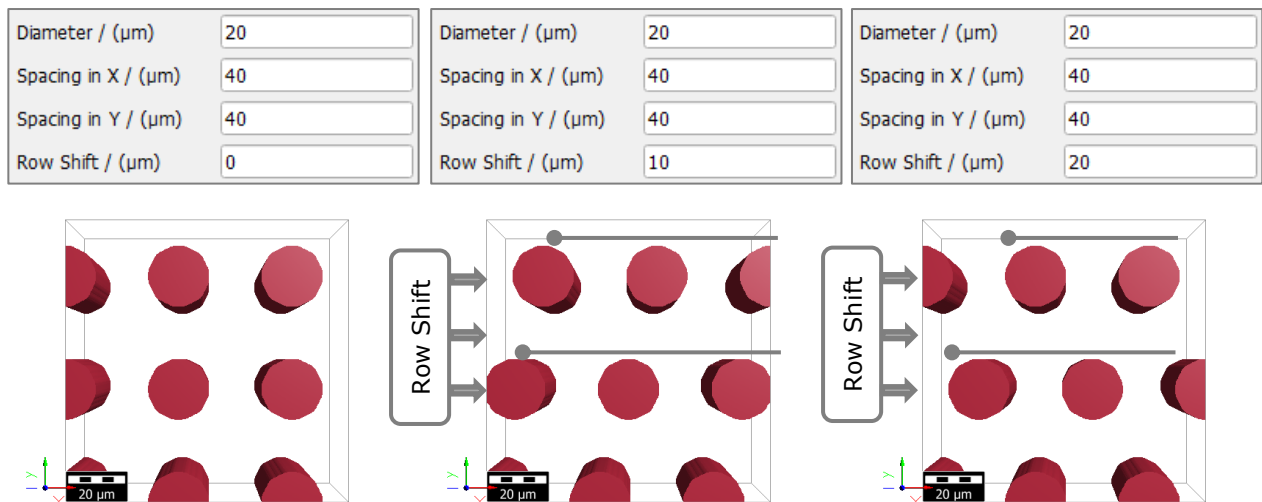

USER-DEFINED GRID

To generate a grid with user-defined objects and unit cell parameters, select **User Defined Grid** from the pull-down menu in the **GridGeo** section. Click the Grid Options' **Edit...** button and set the parameters in the **User Defined Grid Options** dialog box.

A customized **Result File Name (*.gdr)** should be entered to differentiate the results of sets of **GridGeo** generations. The *.gdr result file is automatically placed inside the chosen project folder.

The available units (**m**, **mm**, **μm**, **nm**, and **Voxel**) are selectable on the top-right.

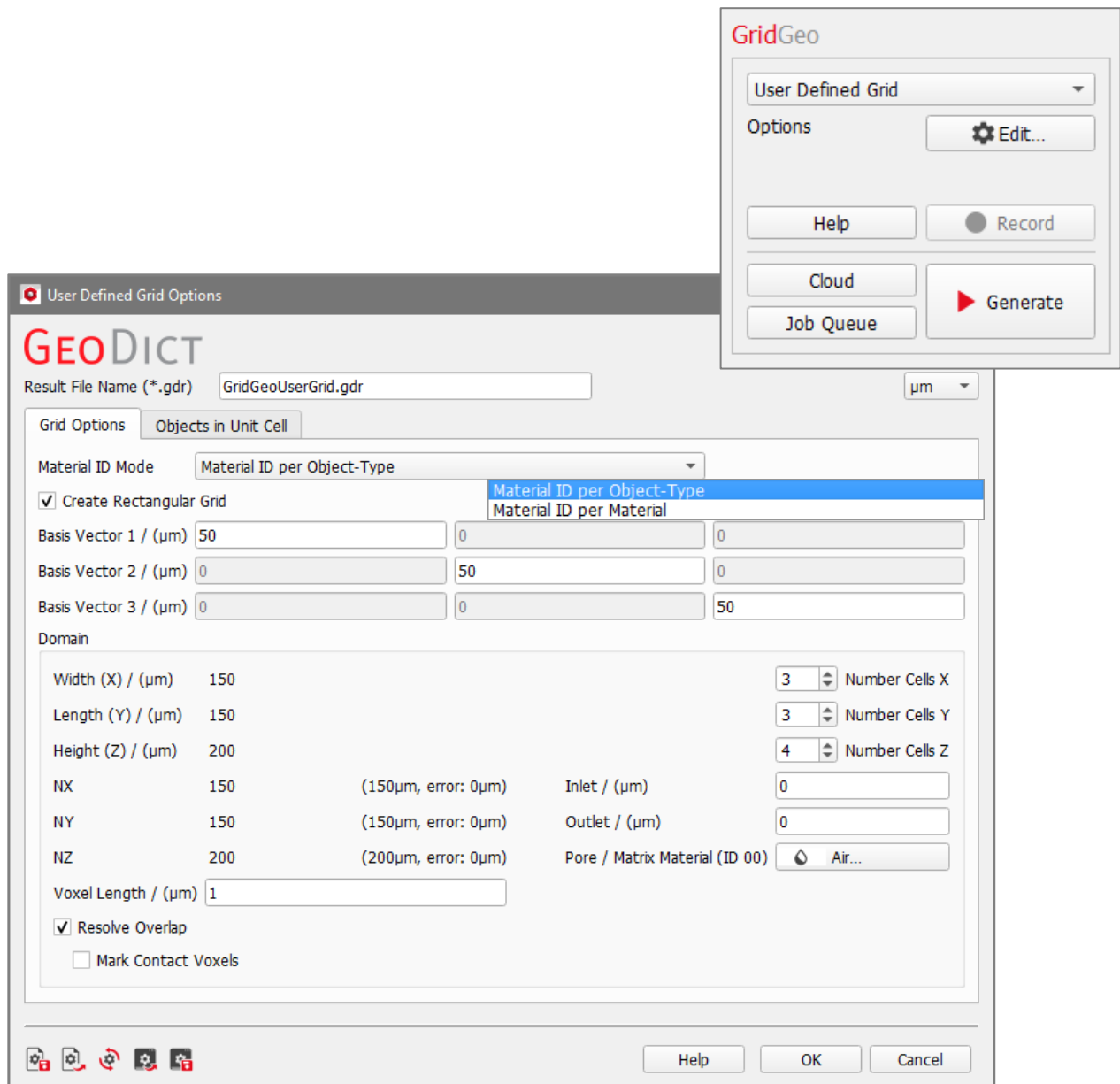

The **Material ID Mode** pull-down menu at the top allows to select between two modes. **Material ID per Material** means that all objects with the same material receive the same **Material ID**. **Material ID per Object-Type** means that objects with different type (e.g. two differently defined spheres) obtain different **Material IDs**, even if they consist of the same material.

The properties of the grid's unit cell can be completely user-defined. The **Basis Vectors** of the unit cell can be chosen to be orthogonal to each other (check **Create**

Rectangular Grid) or can be defined freely in space. Depending on this choice, either the size of the domain (**Width, Length** and **Height**) or the number of unit cells (**Number Cells X, Y** or **Z**) must be defined.

The objects in the unit cell can be set under the **Objects in Unit Cell** tab. User-defined grids with rectangular and non-rectangular grids are explained separately in the following paragraphs.

With **GridGeo-User Defined Grid**, complicated lattices with arbitrary object types can be generated – as for example the default grid shown here.

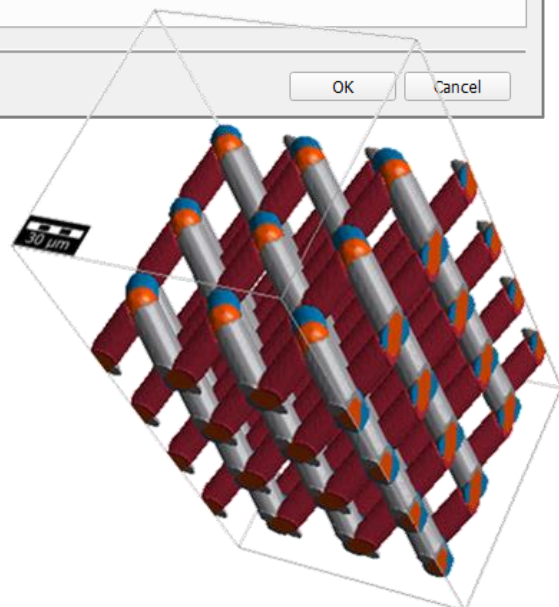

BASIS SETTINGS IN THIS GRIDGEO HANDBOOK

To explain the capabilities of **User Defined Grid**, a simpler approach with only sphere objects is chosen. In this way, the relations between the available parameters can be examined.

The basis vectors define a cubic unit cell with a side length of 100 μm , and only one object is placed in the unit cell: a sphere with the center in the origin and with a diameter of 100 μm . This generates a Simple Cubic grid (see page 4).

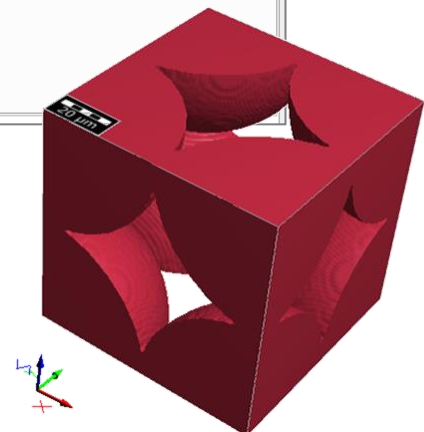
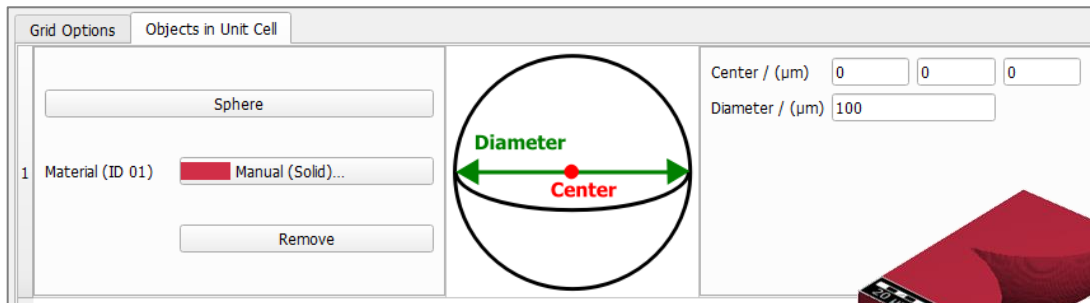
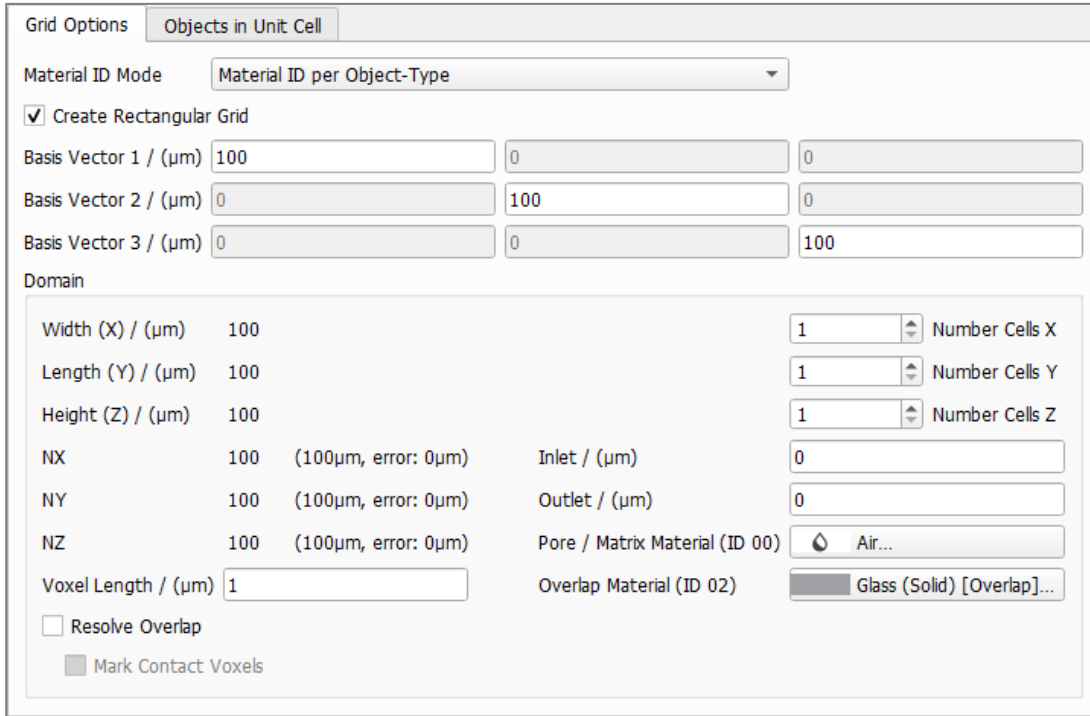

GRID OPTIONS – RECTANGULAR GRID

Create Rectangular Grid

Basis Vector 1 / (μm)	100	0	0
Basis Vector 2 / (μm)	0	100	0
Basis Vector 3 / (μm)	0	0	100

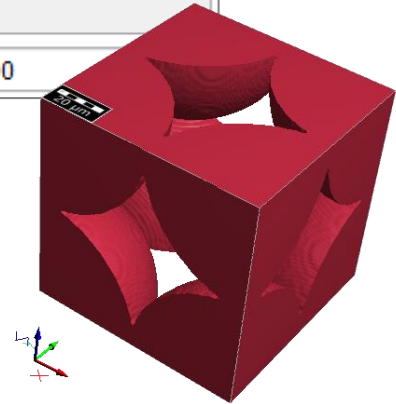

When **Create Rectangular Grid** is checked, the three **Basis Vectors** of the unit cell must be aligned to the X-, Y- and Z-axes. In a periodic grid, the basis vectors define the size and shape of the unit cell and the relation from unit cell to unit cell. The effect of changing the basis vectors is shown below – the shape of the unit cell can be an arbitrary cuboid.

Create Rectangular Grid

Basis Vector 1 / (μm)	100	0	0
Basis Vector 2 / (μm)	0	100	0
Basis Vector 3 / (μm)	0	0	200

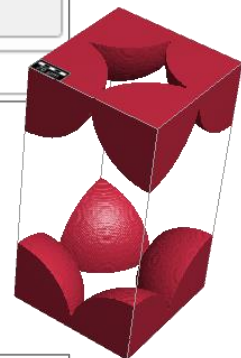

Create Rectangular Grid

Basis Vector 1 / (μm)	90	0	0
Basis Vector 2 / (μm)	0	110	0
Basis Vector 3 / (μm)	0	0	150

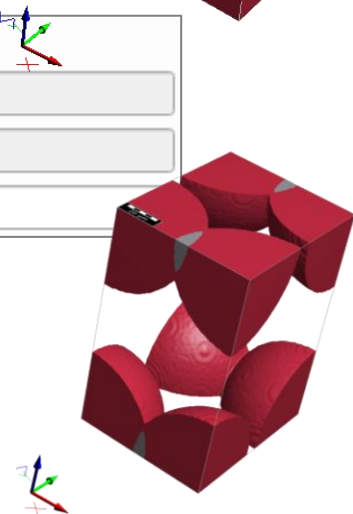

DOMAIN

The **Number Cells X**, **Y** or **Z** sets the number of unit cells in the corresponding direction in the domain.

1 Number Cells X
 1 Number Cells Y
 1 Number Cells Z

1 Number Cells X
 1 Number Cells Y
 2 Number Cells Z

3 Number Cells X
 3 Number Cells Y
 3 Number Cells Z

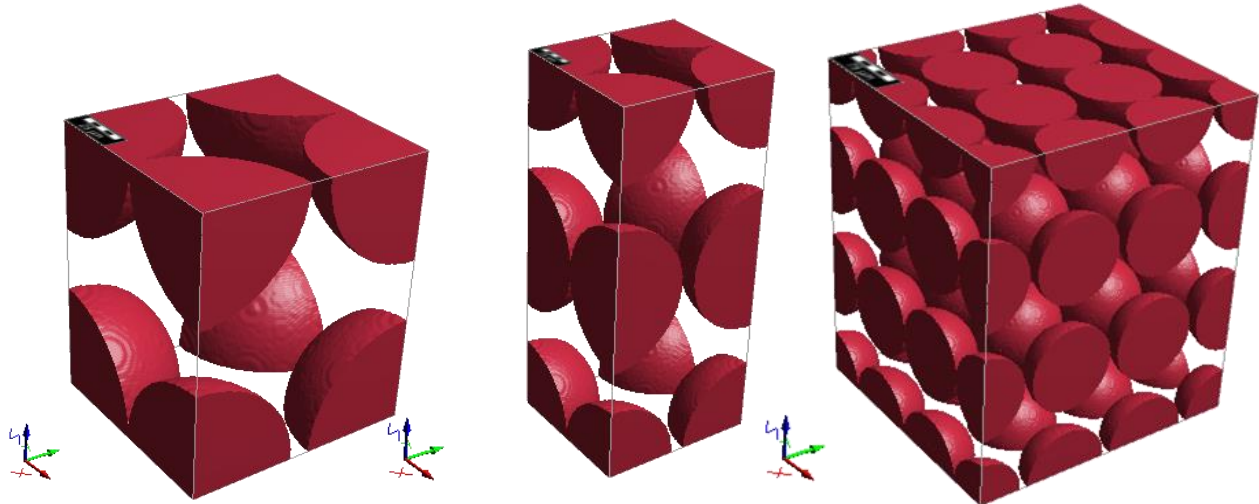

The parameters **Inlet** and **Outlet** add empty space to the domain at the bottom or at the top of the domain. When generating one unit cell without **Inlet** and **Outlet** (Setting both values to 0), the structure is repeated periodically and the objects penetrating the border of the domain reappear at the opposite side. When either an **Inlet** or an **Outlet** is used (by choosing a value larger than 0), the structure is not periodic in z-direction anymore. In this example, the object in the unit cell is a sphere centered in the origin. Therefore, it is not completely contained in the domain when the **Inlet** is set to zero, while the **Outlet** is set to a larger value.

Inlet / (μm) 0	Inlet / (μm) 60	Inlet / (μm) 0	Inlet / (μm) 60
Outlet / (μm) 0	Outlet / (μm) 0	Outlet / (μm) 60	Outlet / (μm) 60

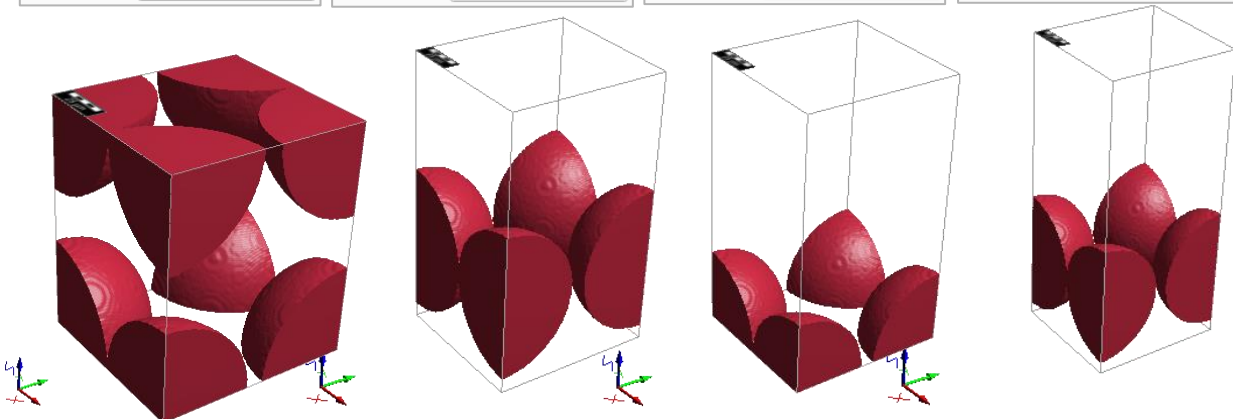

GRID OPTIONS – NON-RECTANGULAR GRID

When **Create Rectangular Grid** is not checked, the three **Basis Vectors** can be defined freely. They must be linearly independent to span a volume in space, so an error message appears if this is not the case.

<input type="checkbox"/> Create Rectangular Grid			
Basis Vector 1 / (μm)	100	0	0
Basis Vector 2 / (μm)	100	0	0
Basis Vector 3 / (μm)	0	0	100

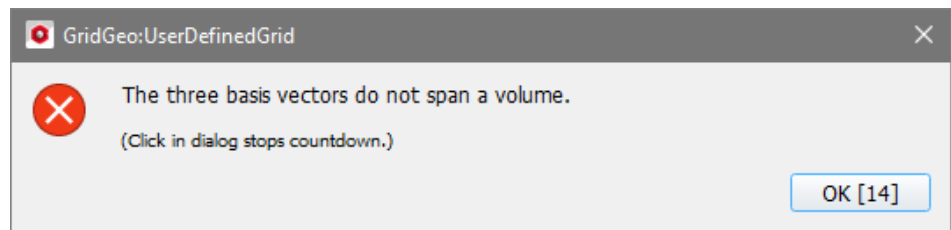

DOMAIN

The domain options now differ from those available in the rectangular case. Since the unit cell might be non-orthogonal or rotated with respect to the **GeoDict** coordinate system, the domain containing the structure can no longer be described by numbers of unit cells in the coordinate directions. Instead, the size of the domain must be entered directly.

As it happened above for the **Rectangular Grid**, the basis vectors define the size and shape of the unit cell and therefore the relation between succeeding unit cells. The effect of using non-orthogonal basis vectors is illustrated in the following figure by changing only one vector (Basis Vector 3).

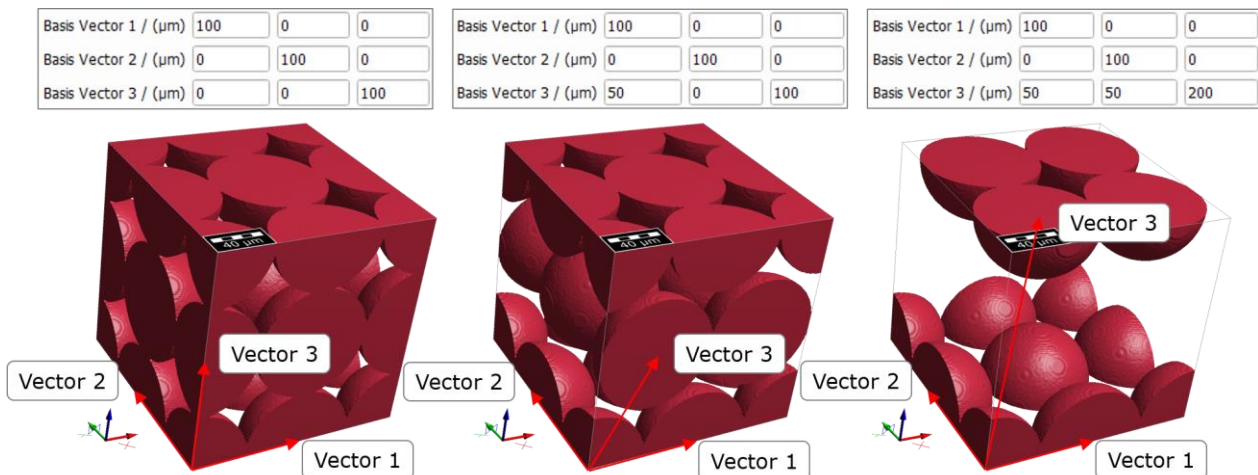

With the use of non-orthogonal basis vectors, the Body-Centered Cubic and Face-Centered Cubic grids can be generated with only one sphere per unit cell.

Lattices with this property are called Bravais lattices. Find out more about them here https://en.wikipedia.org/wiki/Bravais_lattice.

GridGeo section – Grid of Parallel Cylinders

Basis Vector 1 / (μm)	0	115.47	0
Basis Vector 2 / (μm)	57.735	57.735	57.735
Basis Vector 3 / (μm)	115.47	0	0

Width (X) / (μm)	115.47
Length (Y) / (μm)	115.47
Height (Z) / (μm)	115.47

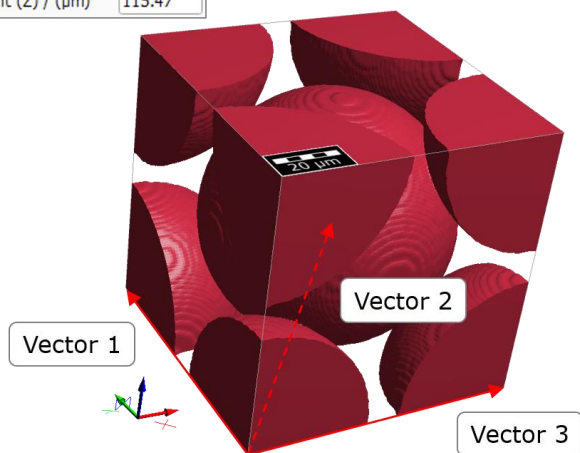

Basis Vector 1 / (μm)	0	70.7107	70.7107
Basis Vector 2 / (μm)	0	0	141.421
Basis Vector 3 / (μm)	70.7107	0	70.7107

Width (X) / (μm)	141.421
Length (Y) / (μm)	141.421
Height (Z) / (μm)	141.421

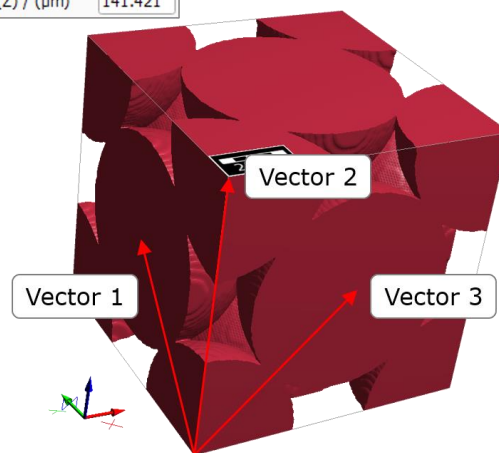

OBJECTS IN UNIT CELL

In the **Objects in Unit Cell** tab, the different objects appearing in the grid can be defined. At the bottom, choose the **Object Type** and click **Add** to define further parameters. With **Remove**, an object can be deleted from the selection. Observe the **Material ID** of each object, which depends on the selection of the Material Mode, see page 15. Change the material, if necessary, by clicking on it and choosing a new material from the Material Selector.

Objects in Unit Cell and **Basis Vectors** must always be regarded in combination.

The first example is a Simple Cubic grid with a smaller sphere in the middle, which can be generated in a rectangular grid.

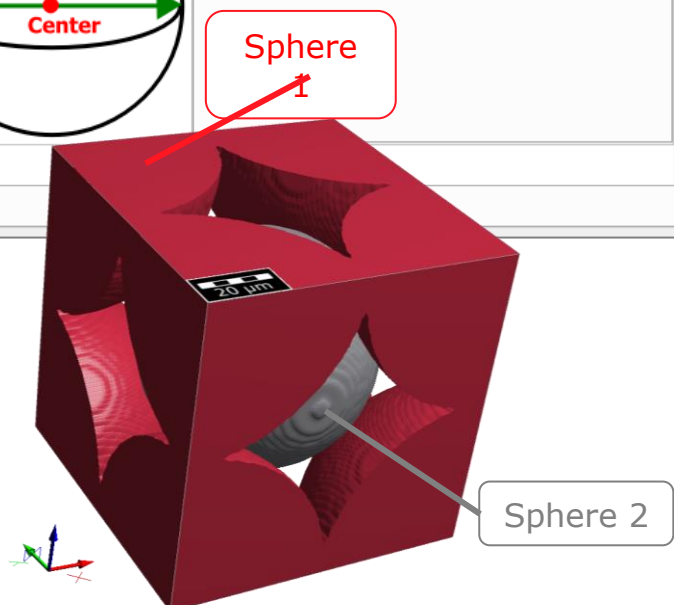
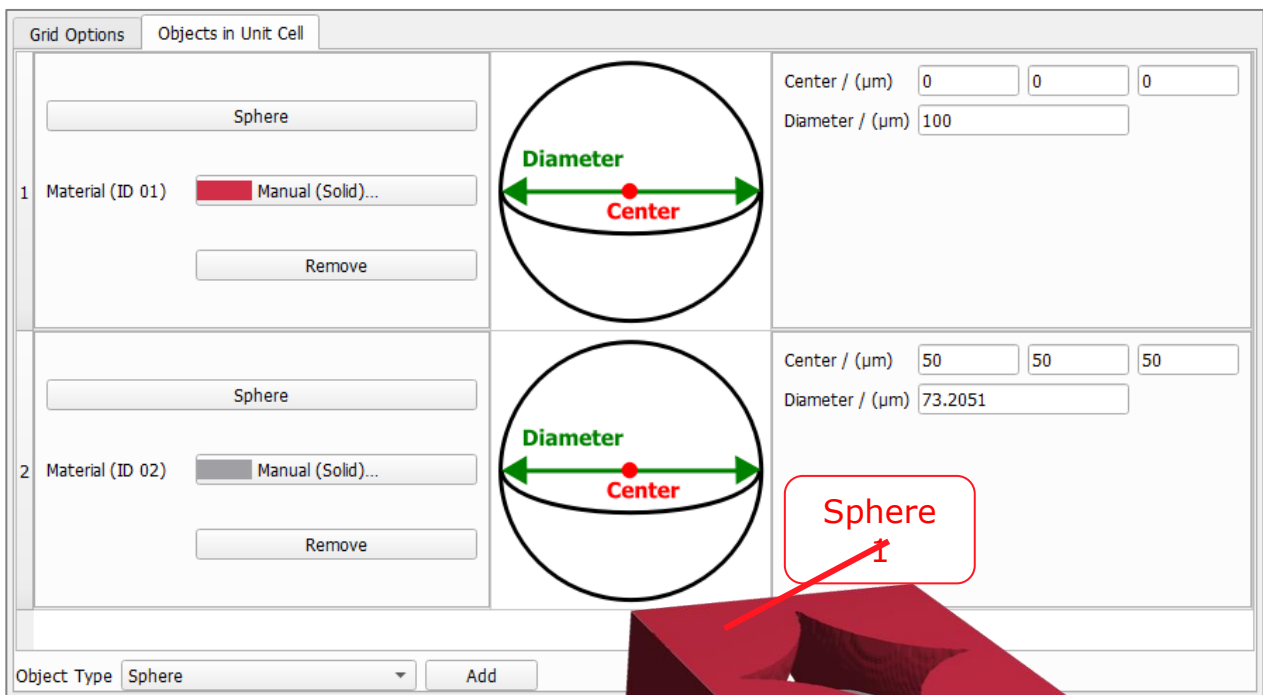
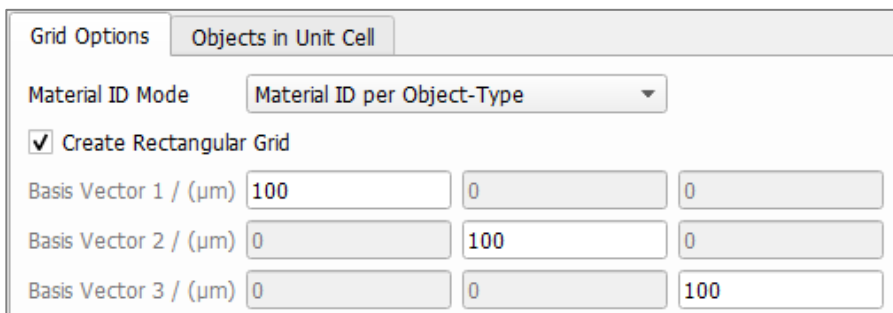

The next example is a HCP grid, which can be generated with two sphere objects in a non-orthogonal grid.

Grid Options **Objects in Unit Cell**

Material ID Mode **Material ID per Object-Type**

Create Rectangular Grid

Basis Vector 1 / (μm)

Basis Vector 2 / (μm)

Basis Vector 3 / (μm)

Domain

Width (X) / (μm)

Length (Y) / (μm)

Height (Z) / (μm)

Grid Options **Objects in Unit Cell**

<p>Sphere</p> <p>1 Material (ID 01) <input type="text" value="Solid..."/></p> <p><input type="button" value="Remove"/></p>		<p>Center / (μm) <input type="text" value="0"/> <input type="text" value="0"/> <input type="text" value="0"/></p> <p>Diameter / (μm) <input type="text" value="100"/></p>
<p>Sphere</p> <p>2 Material (ID 02) <input type="text" value="Solid..."/></p> <p><input type="button" value="Remove"/></p>		<p>Center / (μm) <input type="text" value="50"/> <input type="text" value="28.8675"/> <input type="text" value="81.6497"/></p> <p>Diameter / (μm) <input type="text" value="100"/></p>

Object Type **Sphere**

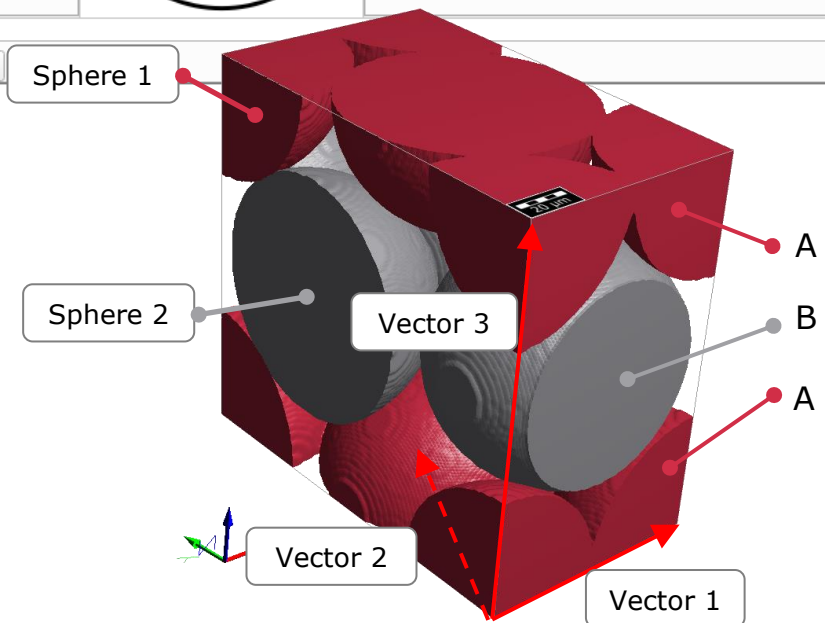

In contrast to the Simple Cubic, Body-Centered Cubic and Face-Centered Cubic lattices, a Hexagonal lattice cannot be generated with only one sphere and three basis vectors. The reason is, that a hexagonal lattice is not a Bravais lattice (https://en.wikipedia.org/wiki/Bravais_lattice). The relation from layer A to layer B is different from the relation of layer B to the next layer A (see also the [Appendix](#)).

PERFORATED FOIL

Perforated Foils can be generated when selecting **Perforated Foil** from the pull-down menu in the **GridGeo** section.

Click the Options' **Edit...** button and enter the necessary parameters in the **Perforated Foil Options** dialog box.

A customized **Result File Name (*.gdr)** should be entered to differentiate the results of sets of **GridGeo** generations. The *.gdr result file is automatically placed inside the chosen project folder.

The available units (**m**, **mm**, **µm**, **nm**, and **Voxel**) are selectable from their pull-down menu.

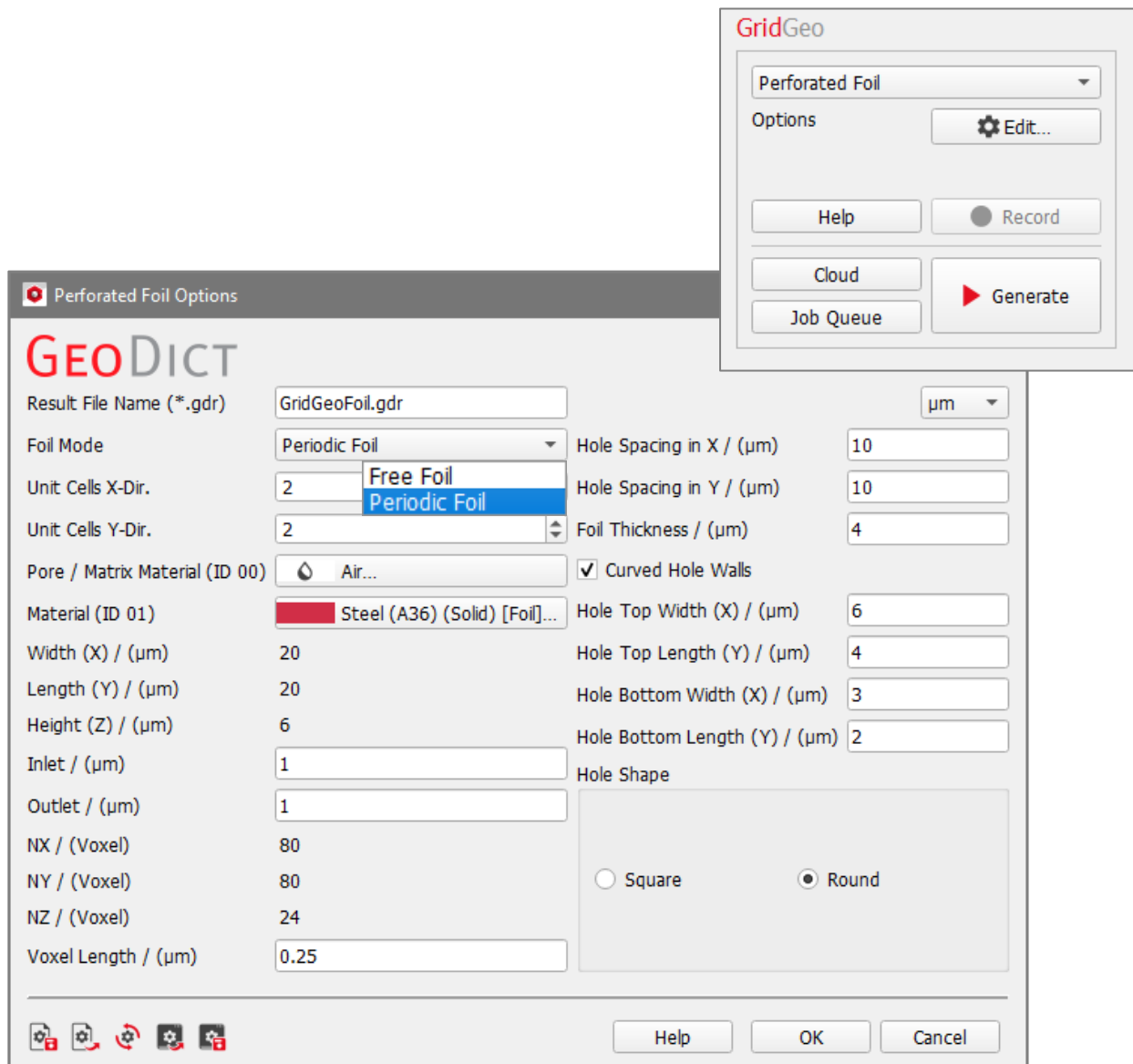

Periodic Foil and **Free Foil** are the **Foil Modes** for the generation of perforated foils in **GridGeo**. **Periodic Foils** fit in a rectangular grid and can therefore be composed of multiple unit cells.

Skewed grids can be generated as **Free Foils** (see the examples below). Rectangular unit cells may be complicated to determine (or may not exist at all), so instead of a desired number of unit cells the overall size of the domain must be set.

Periodic Foils are explained first and, then, additional options are explained for **Free Foils**.

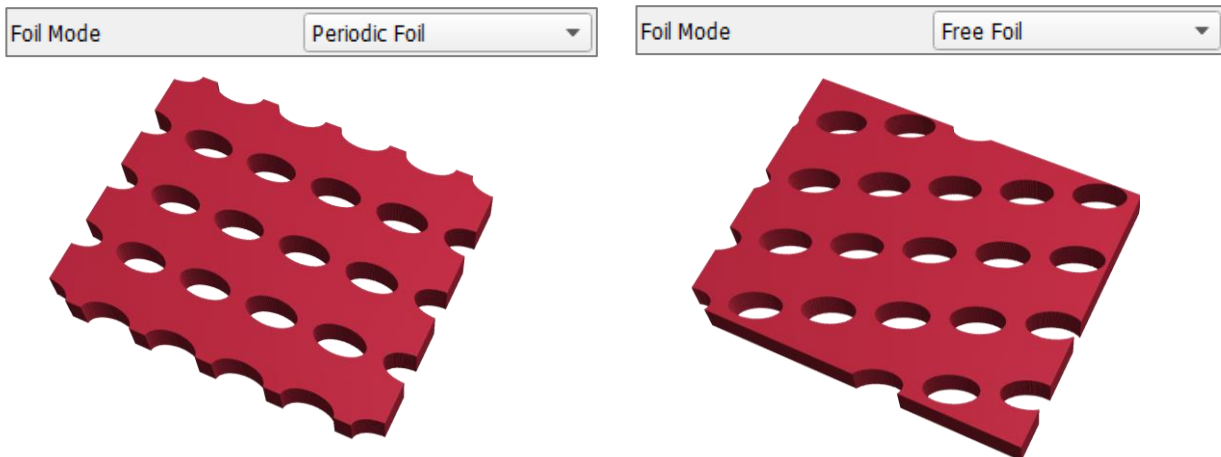

Some parameters are not user-editable, depending on the chosen mode. For example, the **Width (X)**, **Length (Y)** and **Height (Z)** are not editable for periodic foils, since they depend on other parameters, such as the number of unit cells or the hole spacing parameters. The same holds for the number of voxels **NX**, **NY** and **NZ**, which depend additionally on the **Voxel Length**.

PERIODIC FOIL

Periodic Foils are composed of one or multiple unit cells. One-unit cell consists of a flat piece of foil with one hole, which can be repeated periodically. The hole in the unit cell is in the center of the domain. In the figure below, periodic foils consisting of one, four or twelve-unit cells are shown.

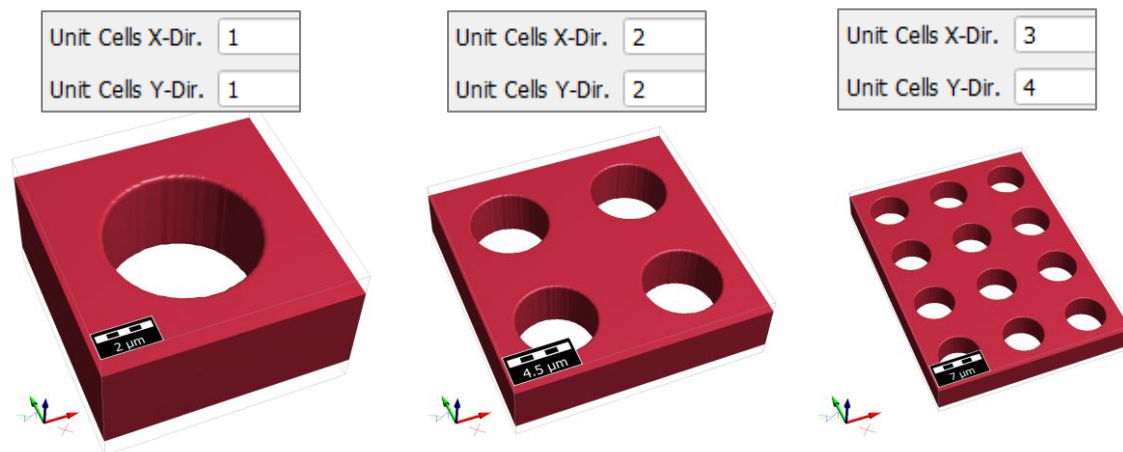

The materials of the foil and the medium surrounding it can be chosen from the **GeoDict** material database by clicking the buttons **Pore / Matrix Material (ID 00)** and **Material (ID 01)**.

Inlet and **Outlet** define the height of the empty area above and below the foil. These parameters might be of interest for flow simulations on the foils, or when embedding them in other structures.

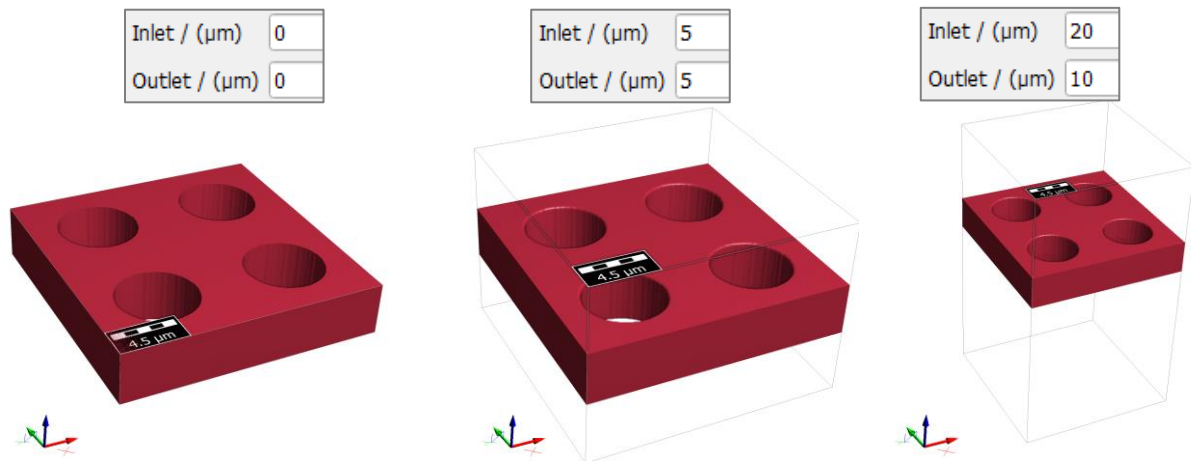

The **Voxel Length** determines the size of a voxel in the selected length unit and therefore the resolution of the structure.

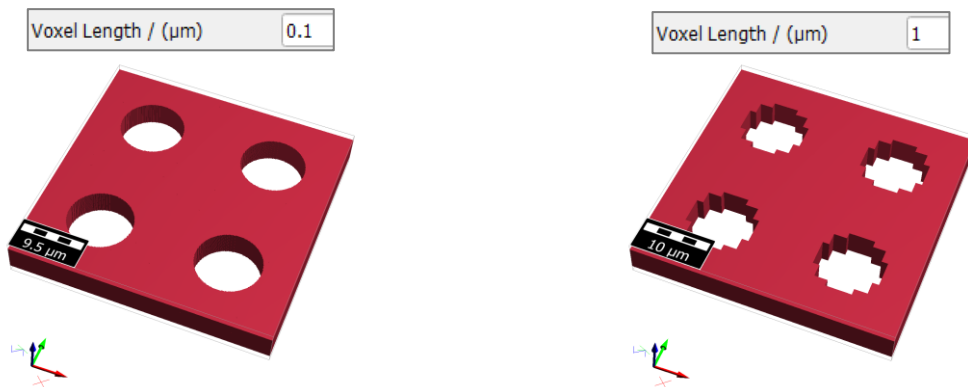

The **Hole Spacing in X** and **Hole Spacing in Y** define the distance between subsequent hole centers, as shown in the figure below.

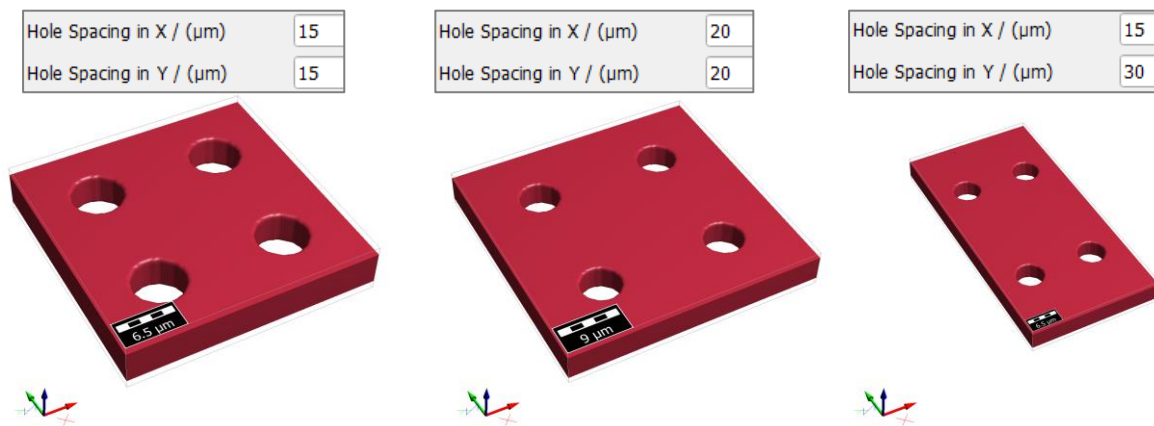

The **Foil Thickness** determines the height of the foil structure.

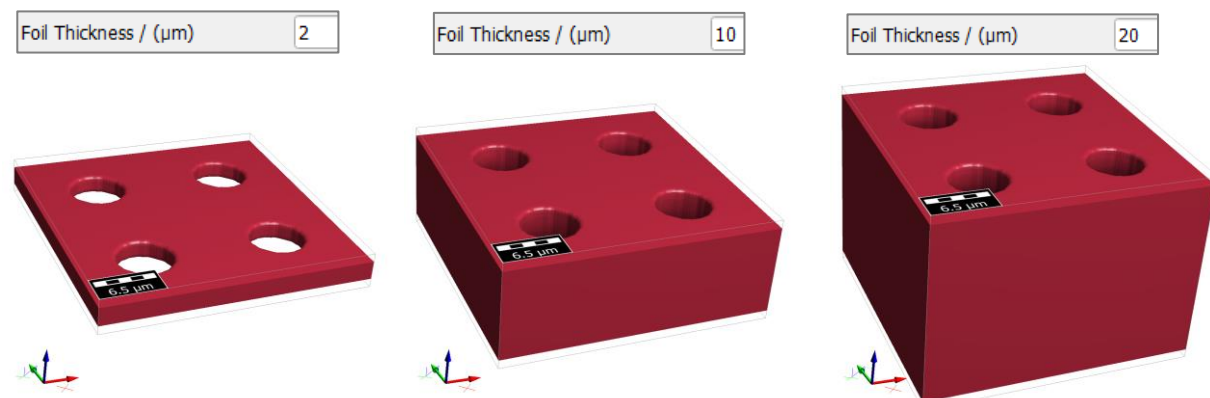

Generating lattices in 2D and in 3D

The parameters defining the hole shape are explained in combination in the following figures. The main shape of the holes can be defined by selecting **Round** or **Square** for the **Hole Shape**. The hole dimensions at the top and bottom of the foil can be determined by setting **Hole Top Width (X)**, **Hole Top Length (Y)**, **Hole Bottom Width (X)** and **Hole Bottom Length (Y)**. With these options, a large variety of hole shapes (e.g. straight or conical holes) is possible.

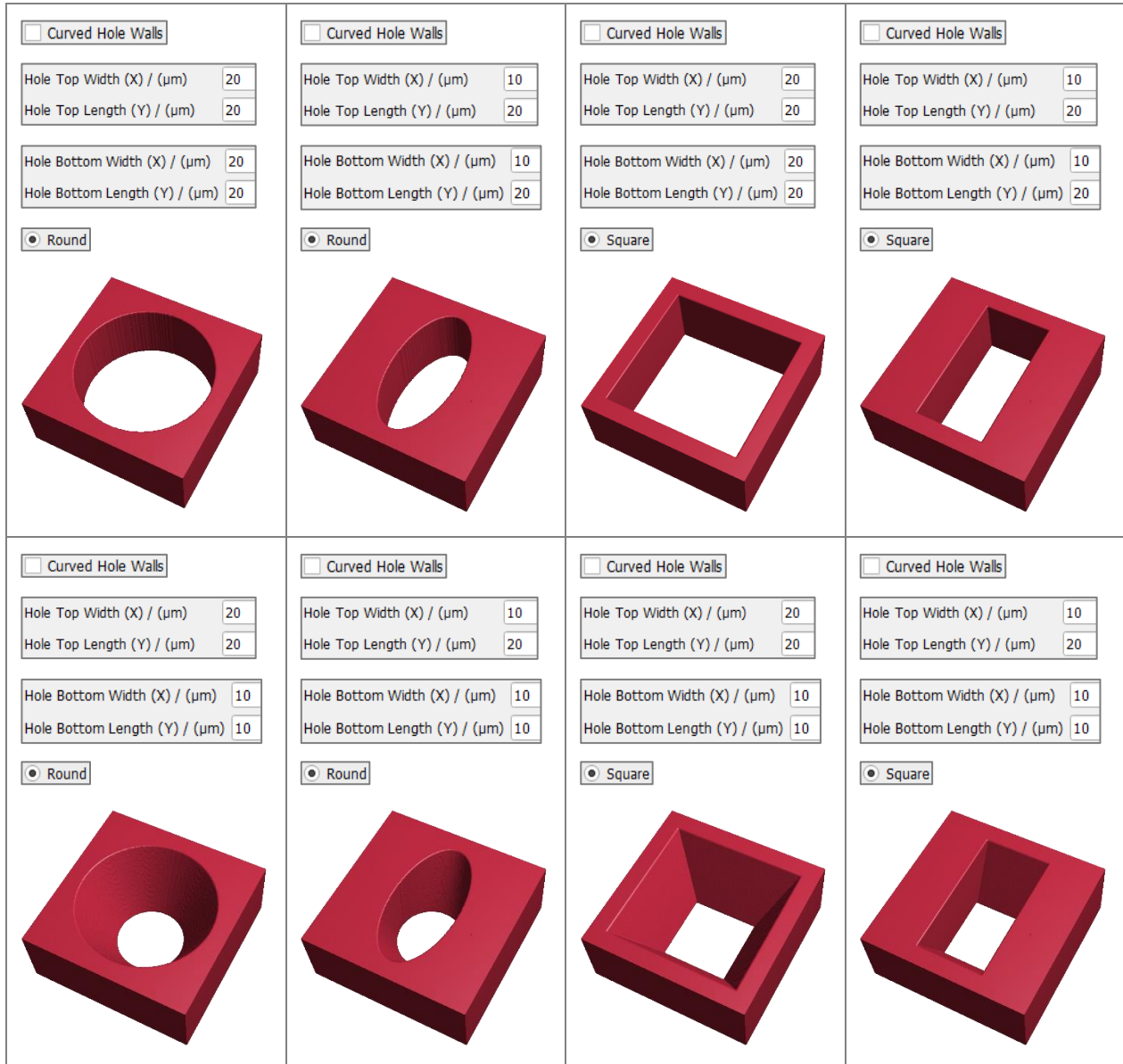

Furthermore, the hole walls can be chosen to be curved (**Curved Hole Walls**). This option has only an effect, when the hole has different sizes at the top and bottom.

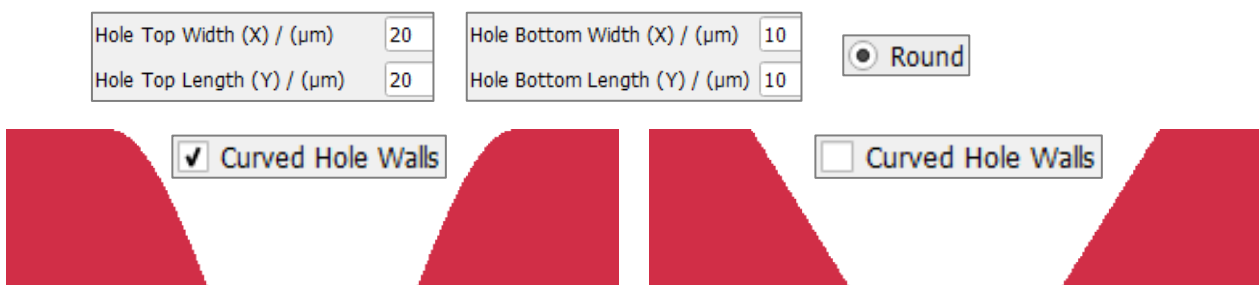

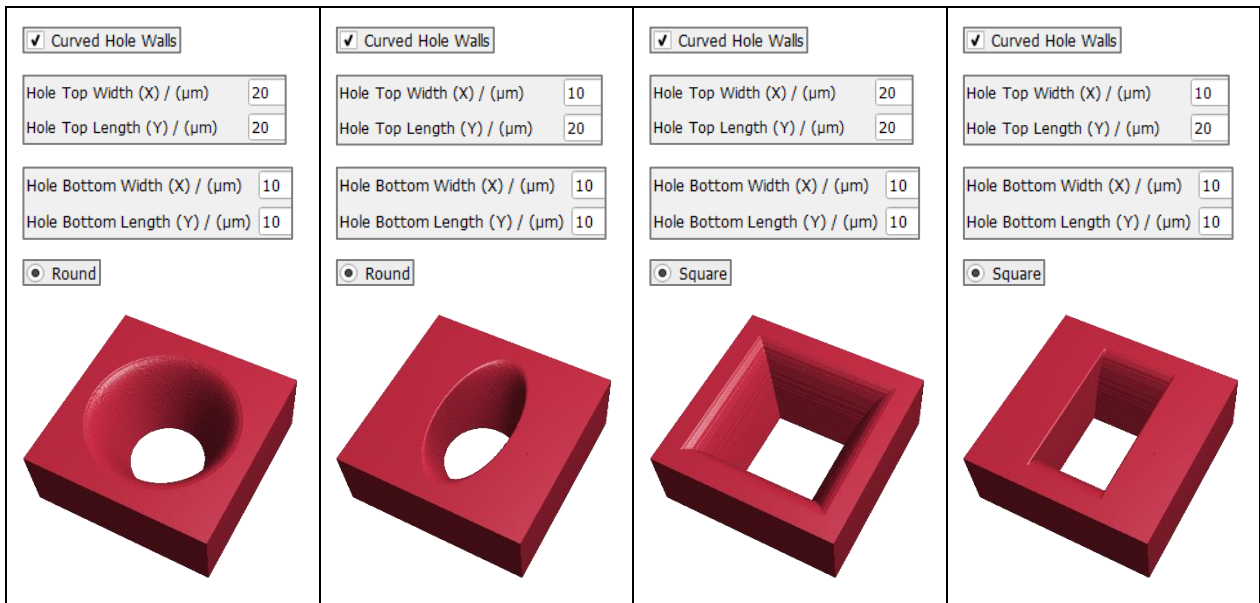

FREE FOIL

The Perforated Foil Options dialog changes in some details when choosing **Free Foil** instead of **Periodic Foil**. The option to select several unit cells is no longer available, instead the **Width (X)** and **Length (Y)** of the foil can be chosen directly. The options to select the **Row Shift** and the **Rotation Angle** are added. In most cases, the foil cannot be repeated periodically. Only the new options are described, for the others see the description above.

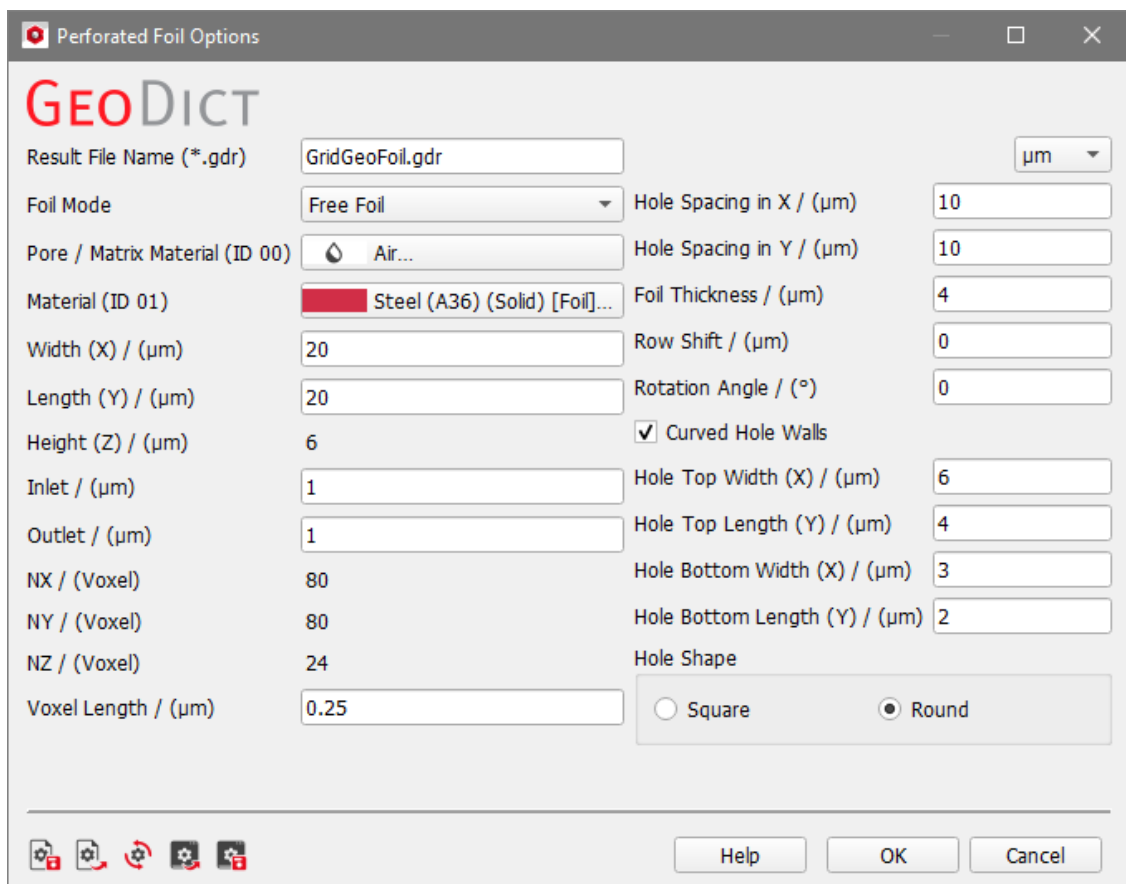

Selecting the **Width (X)** and **Length (Y)** defines the dimension of the domain.

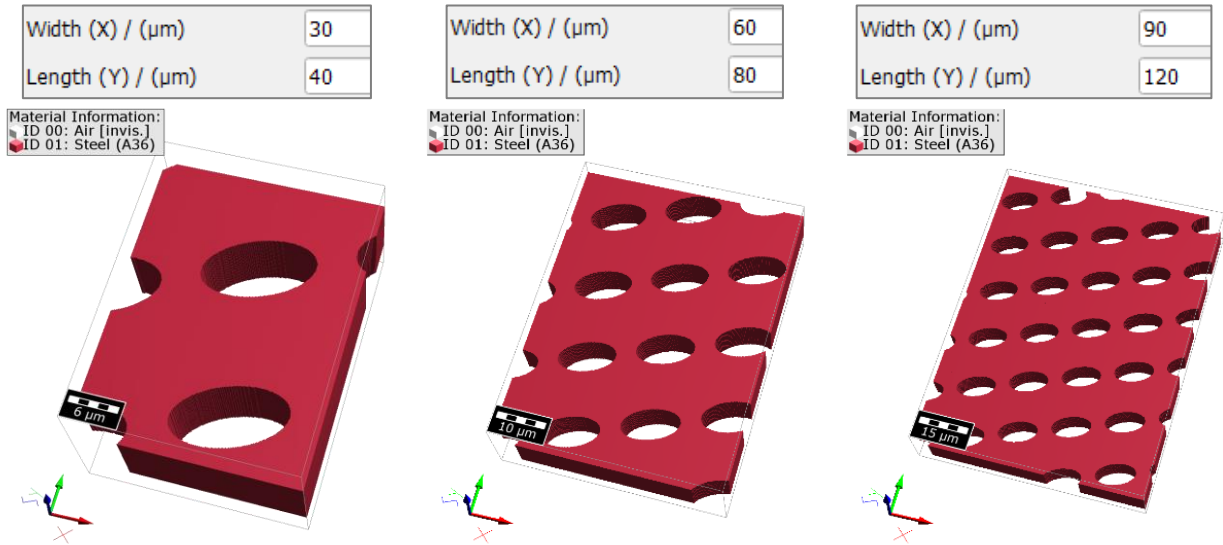

The **Row Shift** defines the distance by which subsequent rows are shifted in X-direction.

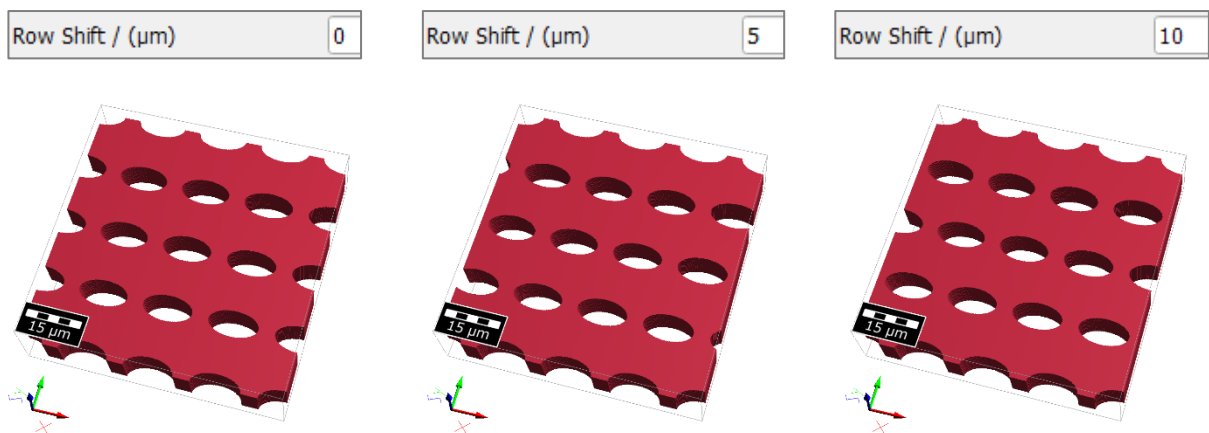

Finally, the **Rotation Angle** is the angle in degrees by which the whole lattice is rotated around the Z-axes of the domain.

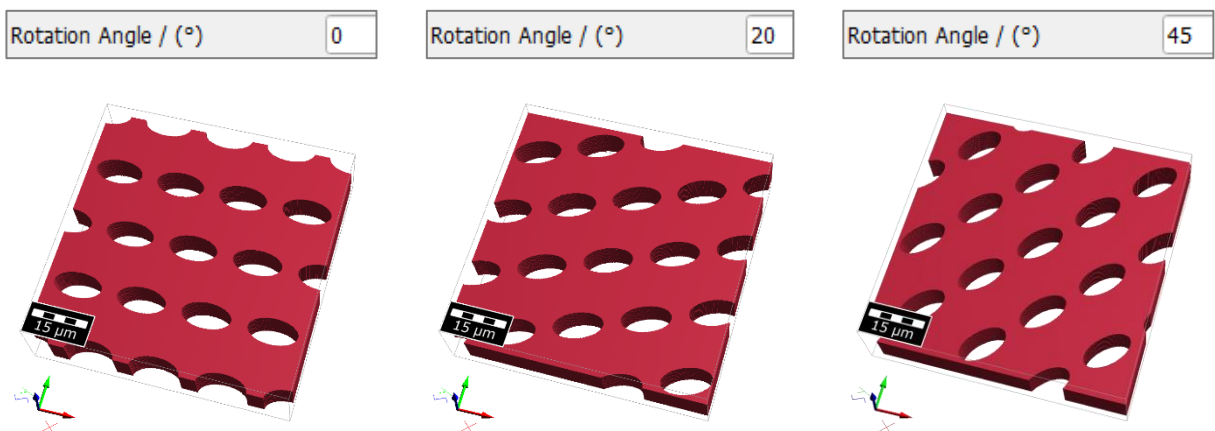

GRID GEOAPPS

In **GridGeo**, two additional generator scripts for periodic structures of interest in several fields of application are available under **Grid GeoApps**. These are:

- **Strut-Based Lattices** which are constructed from nodes on the edges or vertices of the unit cell connected via straight beams.
- **Triply Periodic Minimal Surfaces** are mathematically created surfaces which are not self-intersecting or enfolded. They can be packed together in a periodic 3D pattern, locally minimizing the surface area for a given boundary resulting in a mean curvature of zero.

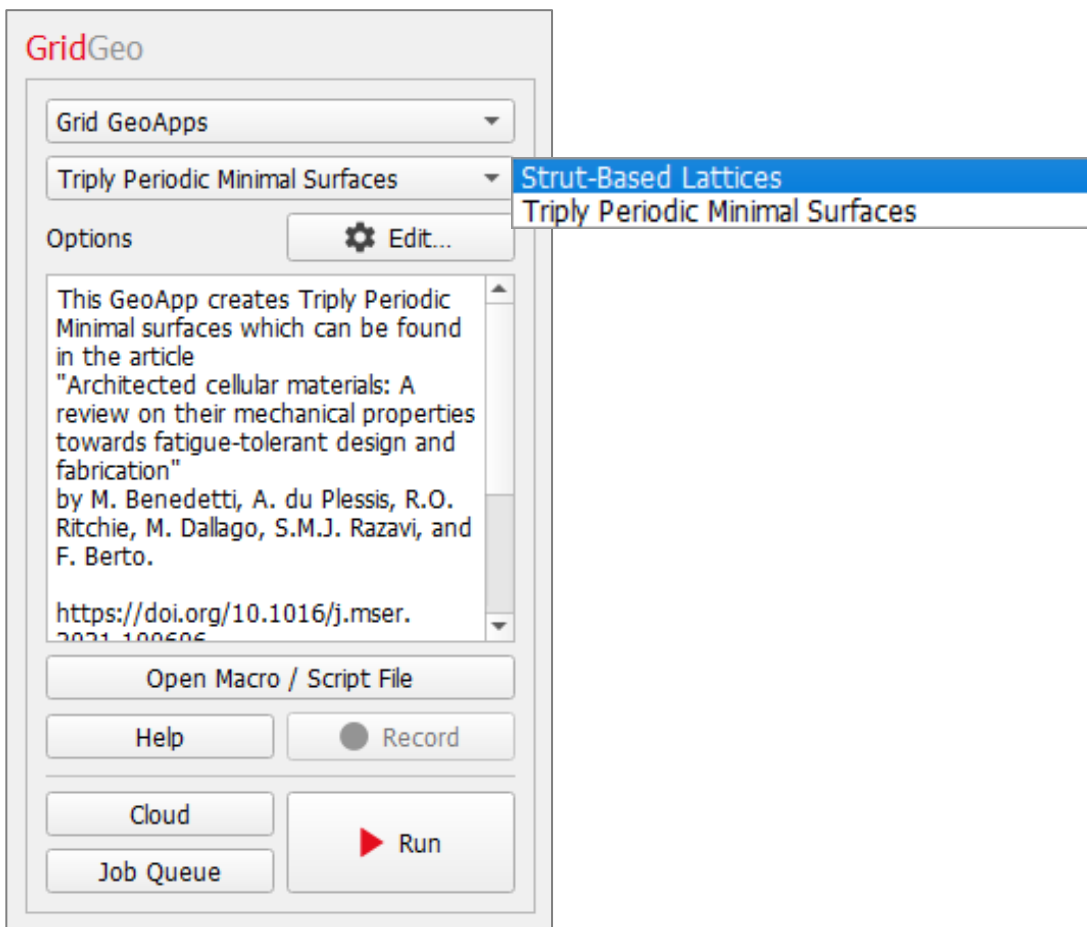

The user may change the generation parameters by choosing one of these predefined generator scripts and clicking the **Options' Edit...** button. After that, clicking **Run** in the **GridGeo** section generates the modified microstructure.

STRUT-BASED LATTICES

ALL-FACE-CENTERED-CUBIC-(AFCC)

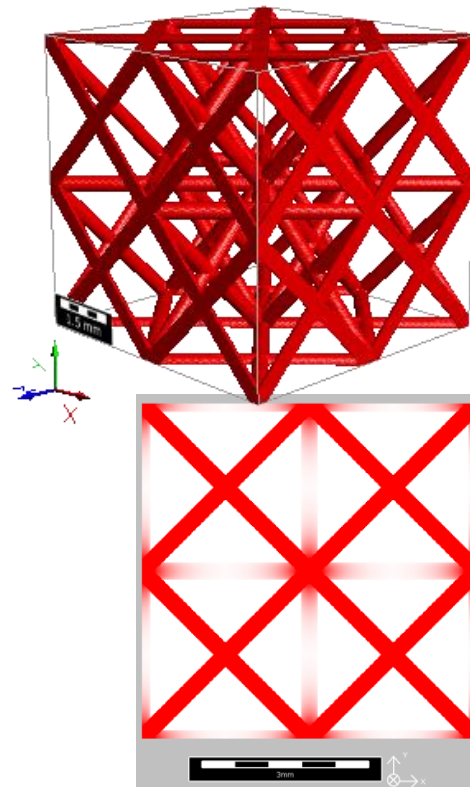
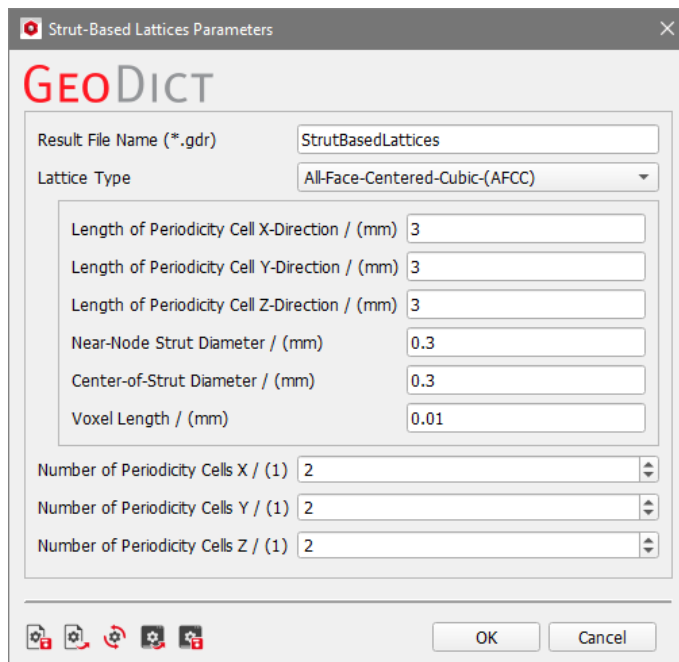

AUXETIC

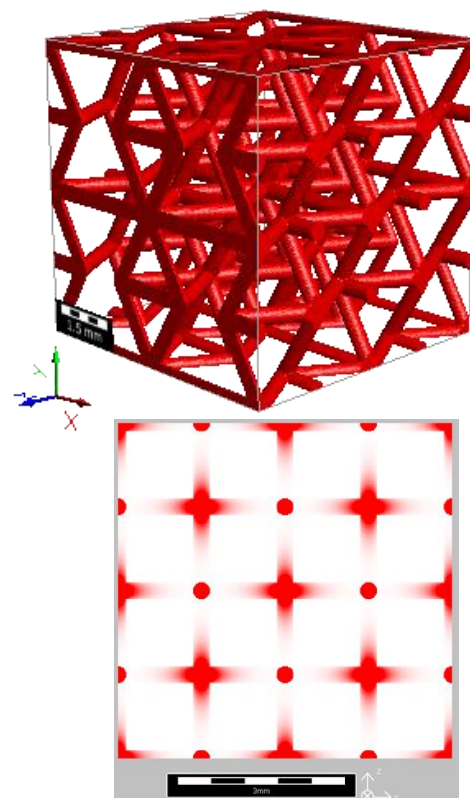
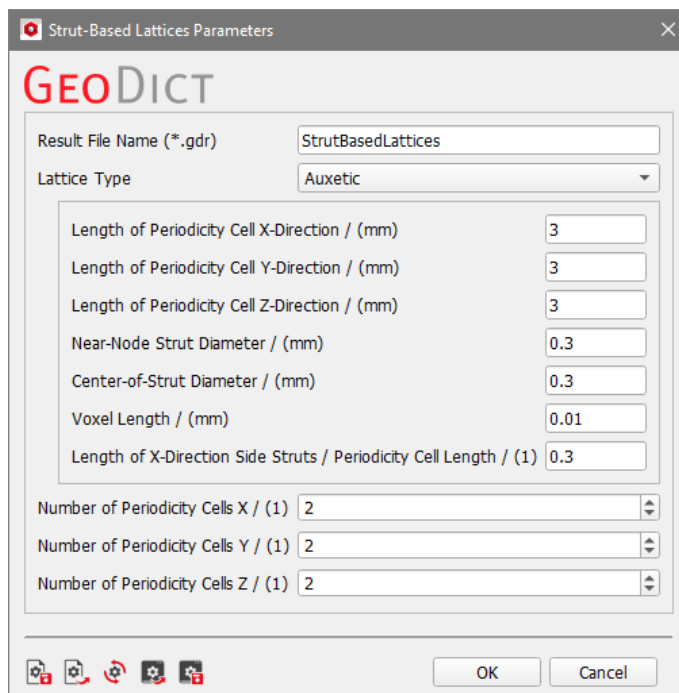

BODY-CENTERED-CUBIC-(BCC)

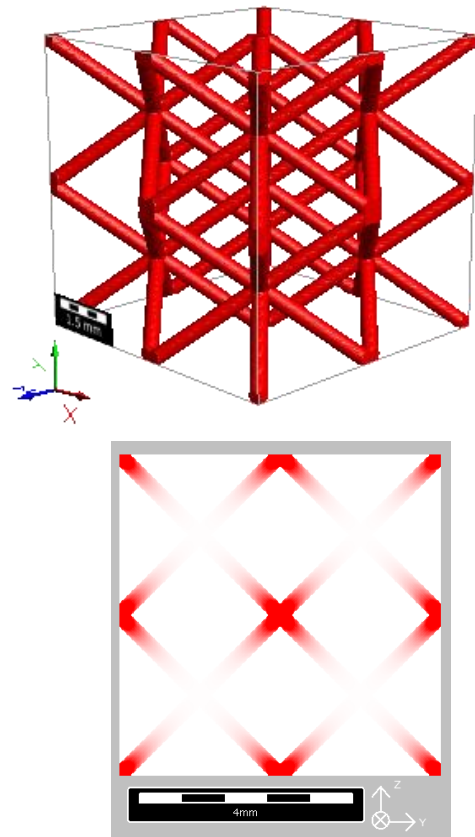
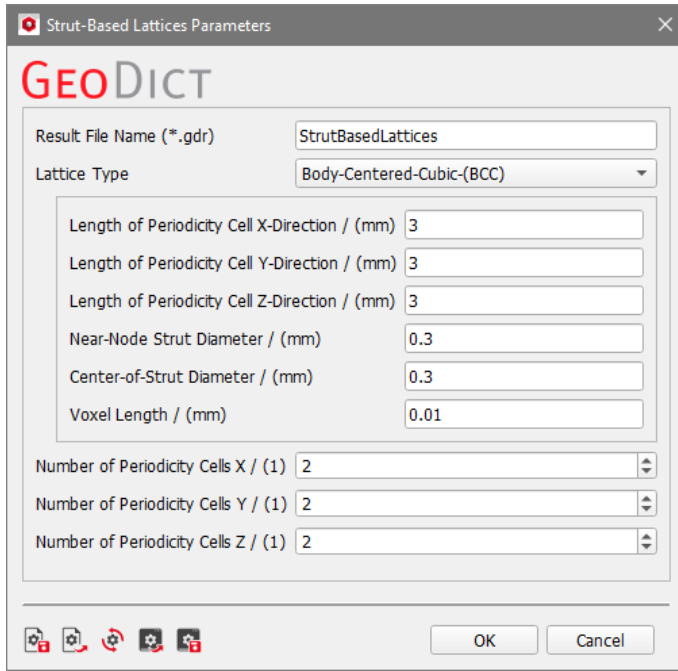

BCC-WITH-Z-STRUT-(BCCZ)

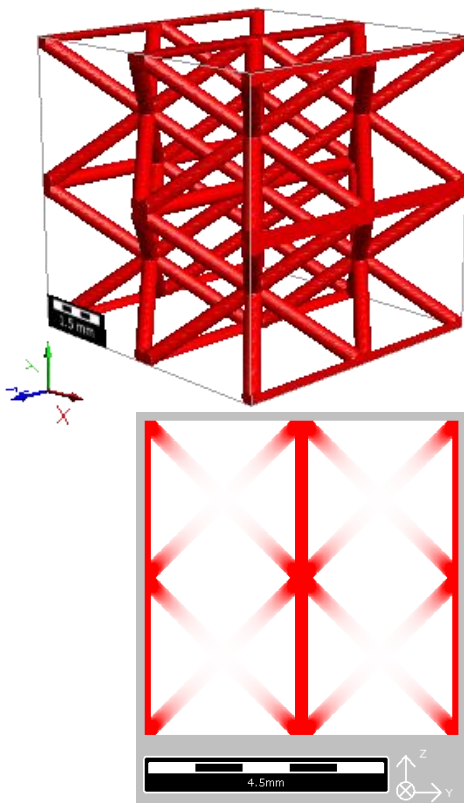
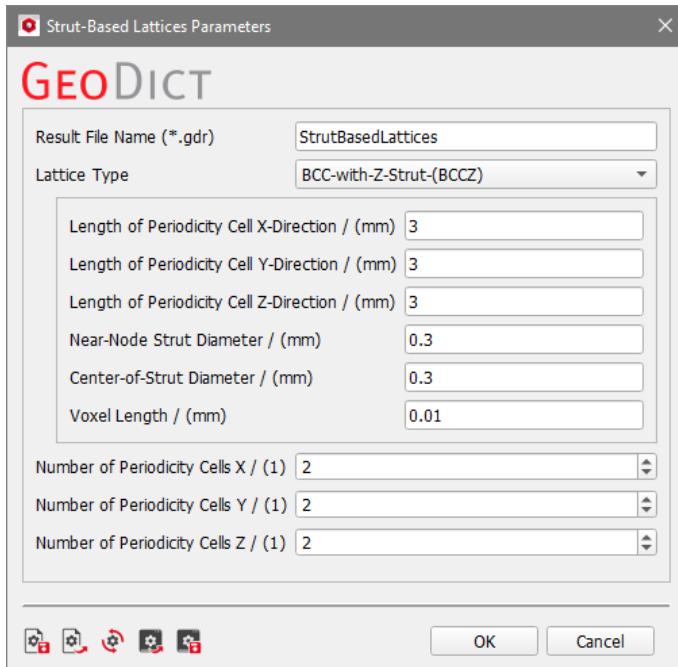

Generating lattices in 2D and in 3D

CUBIC

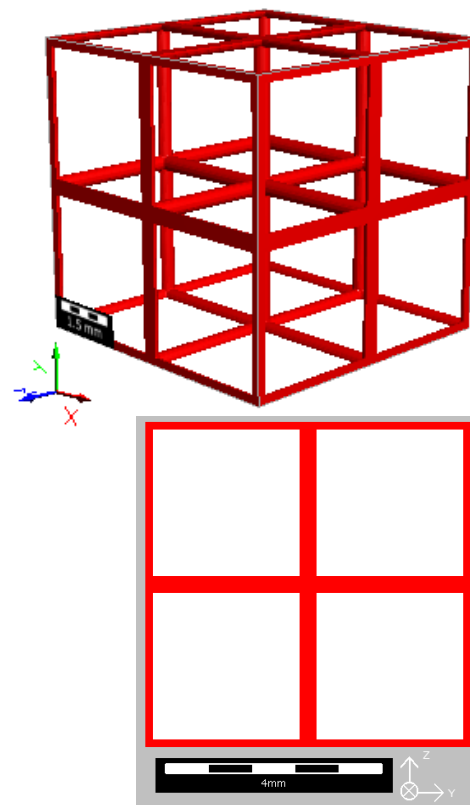
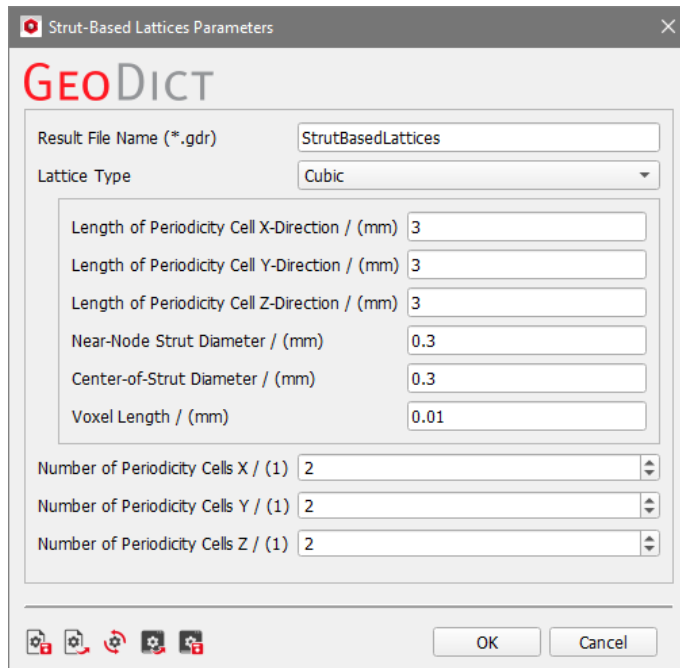

CUBOCTAHEDRON-Z

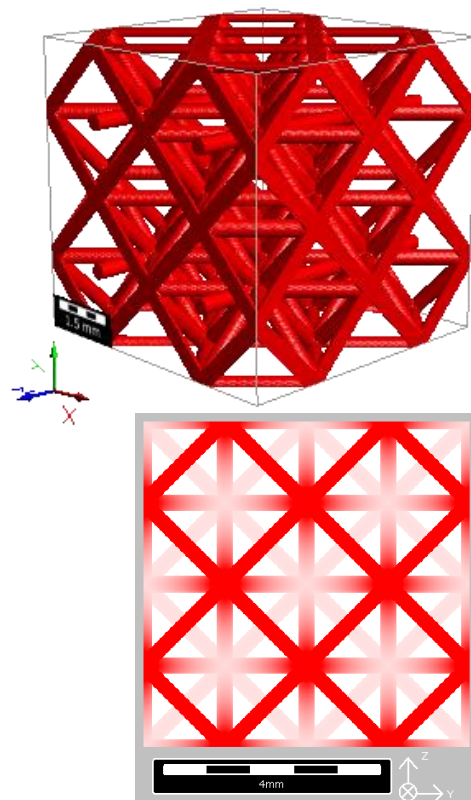
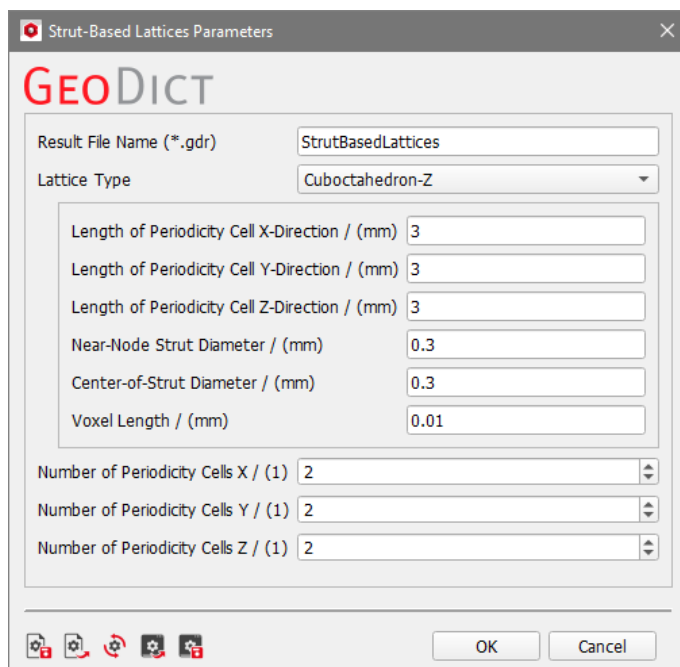

DIAMOND-(PENTA-MODE)

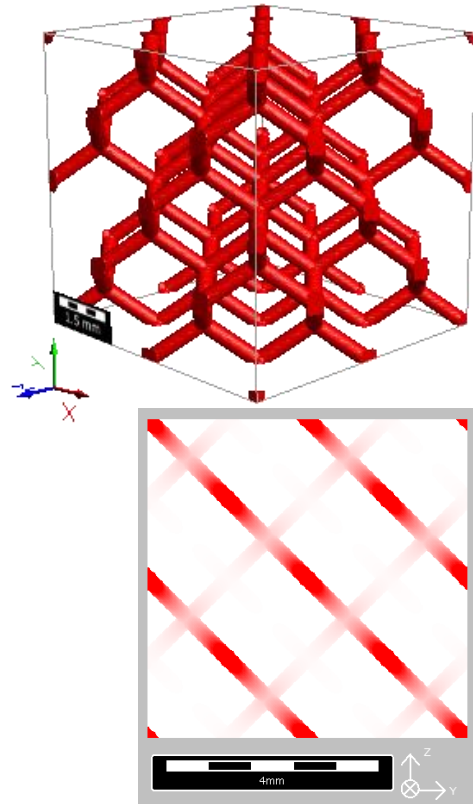
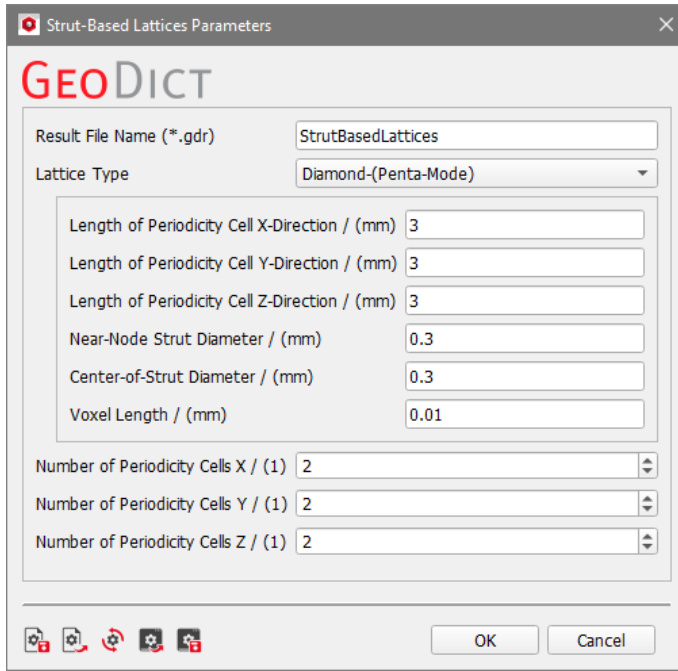

FACE-CENTERED-CUBIC-(FCC)

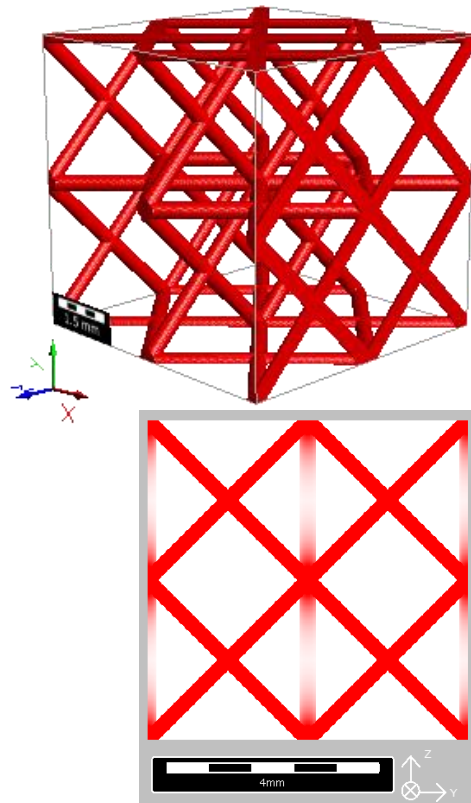
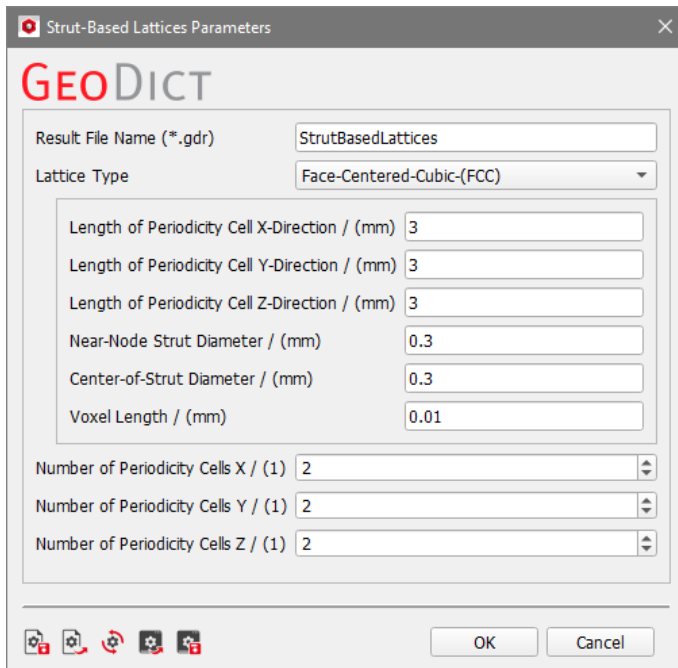

Generating lattices in 2D and in 3D

FCC-WITH-Z-STRUT-(FCCZ)

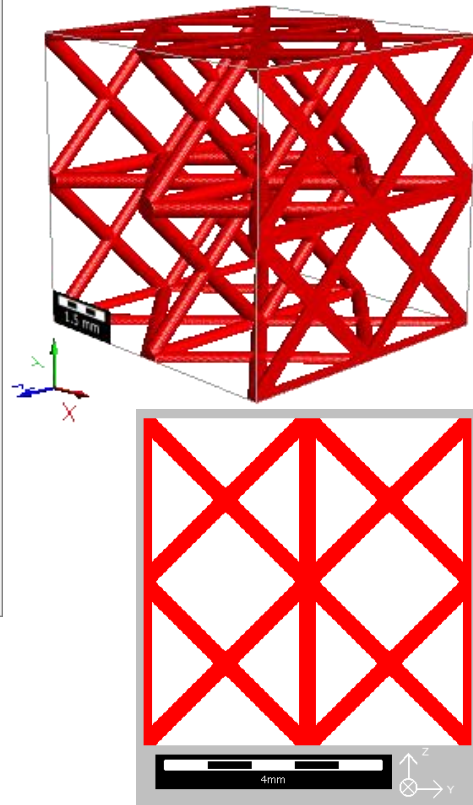
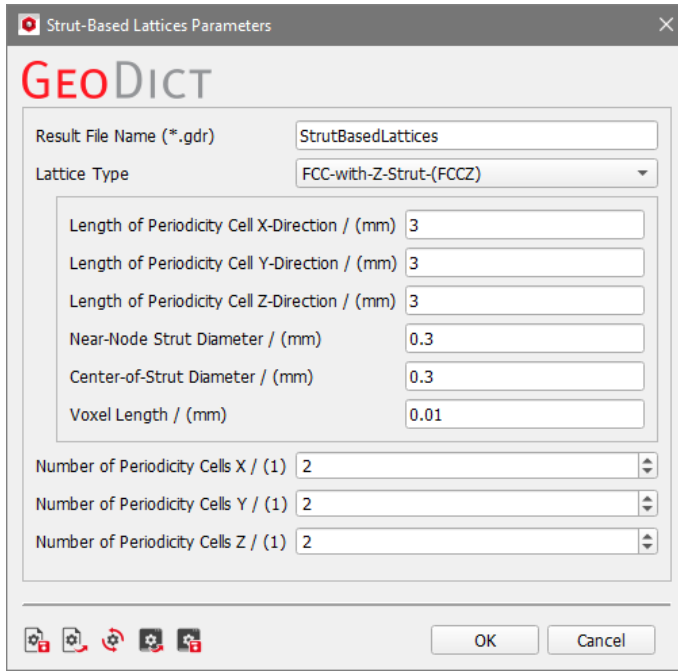

FCC-PLUS-BCCZ-(FBCCZ)

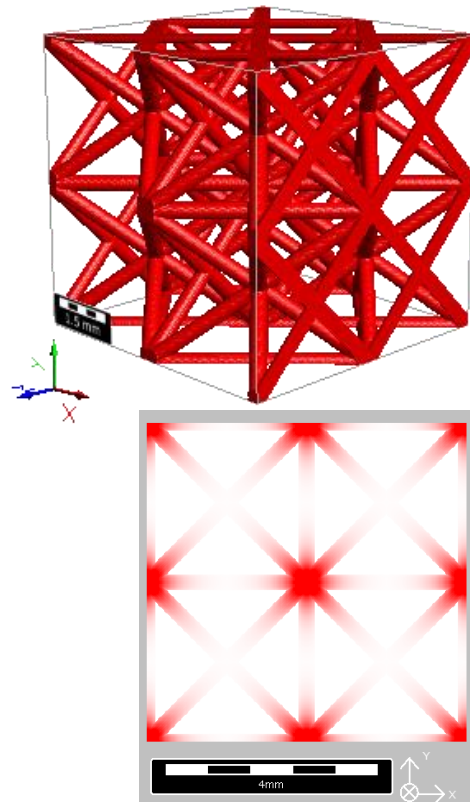
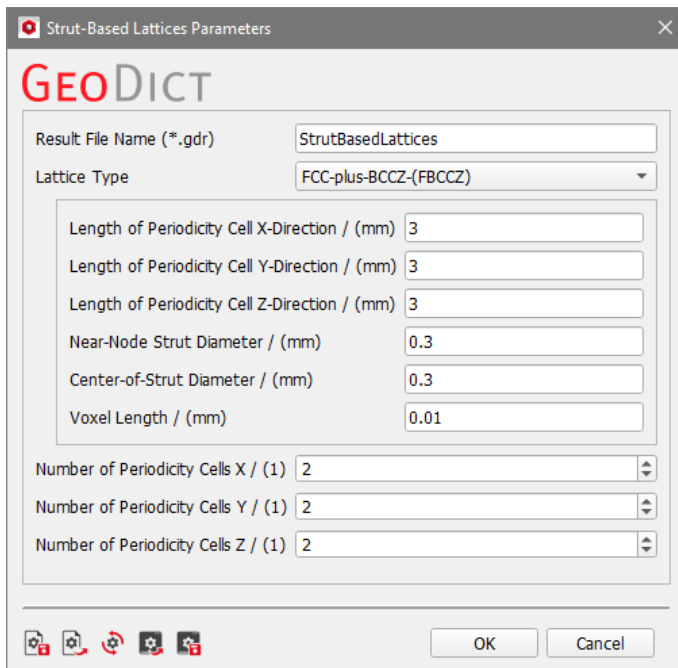

FBCCZ-WITH-X-STRUT-AND-Y-STRUT-(FBCCXYZ)

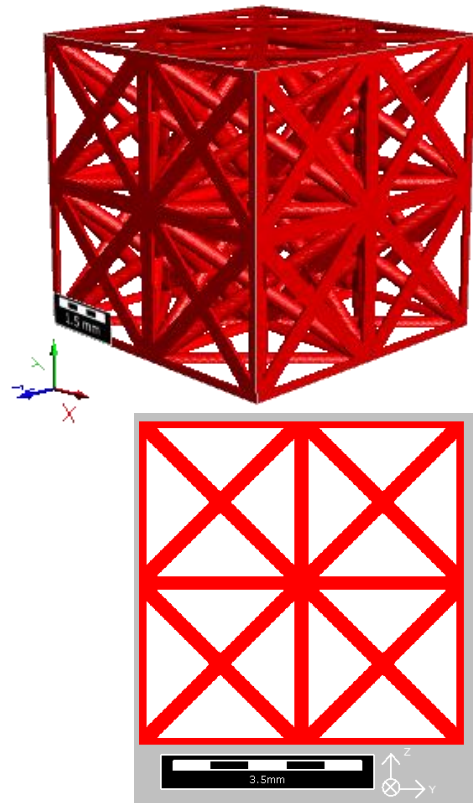
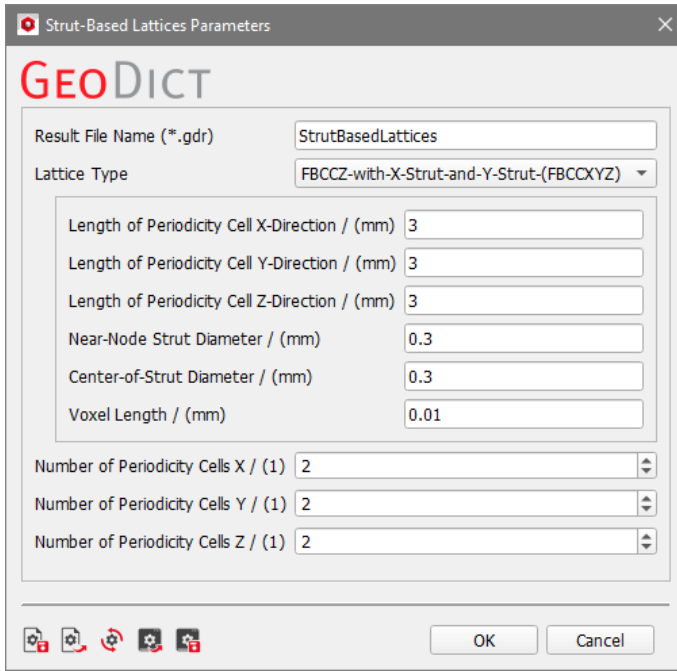

G7

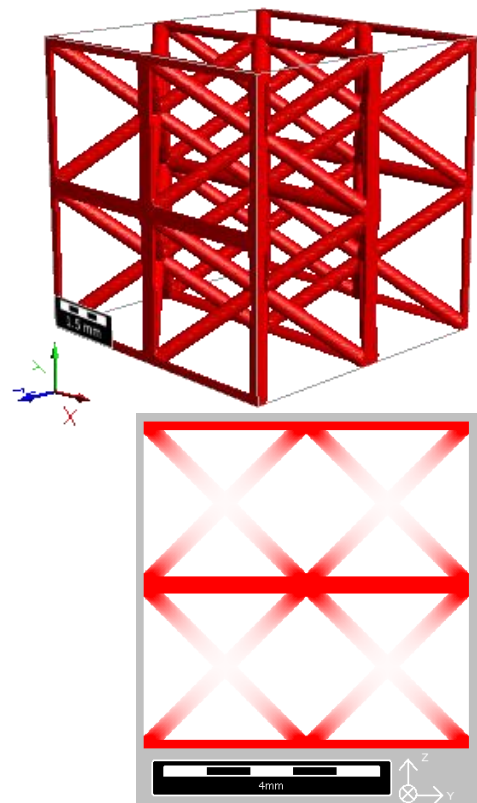
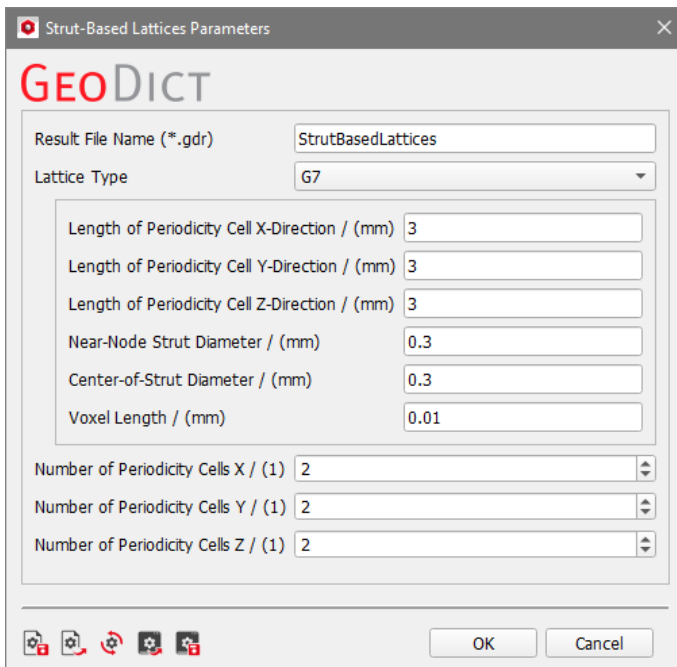

ISO-TRUSS

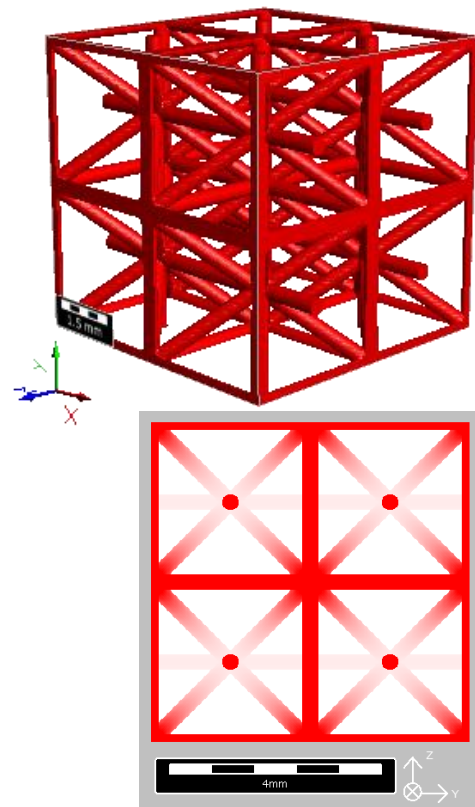
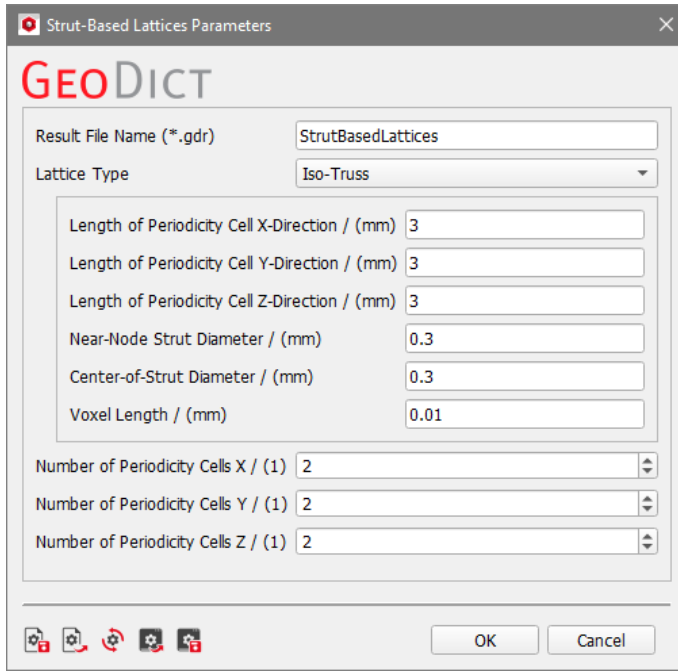

KELVIN

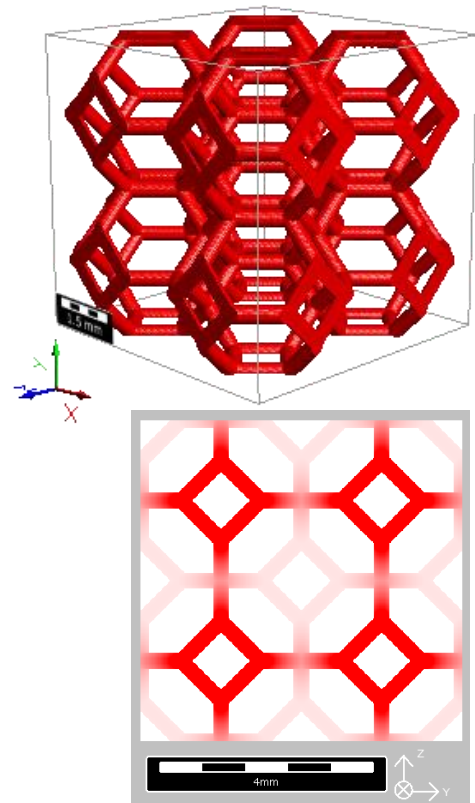
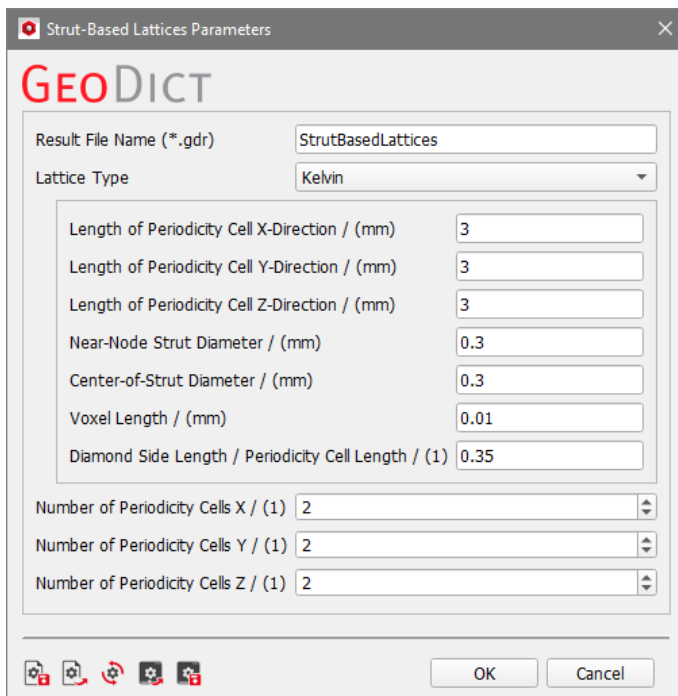

OCTAHEDRON

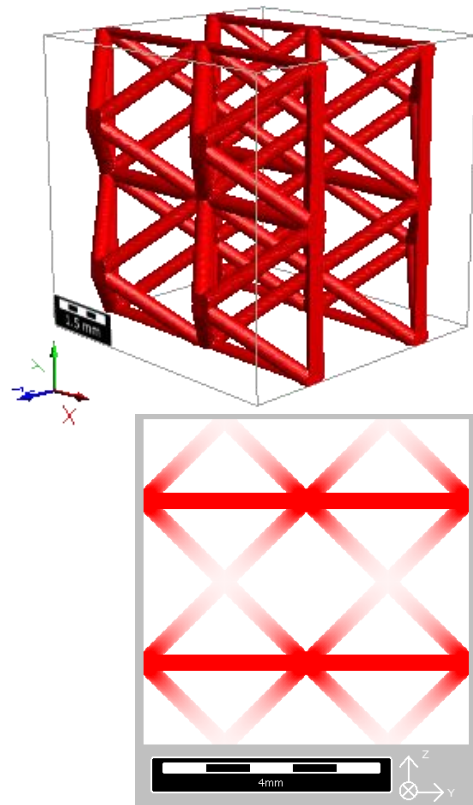
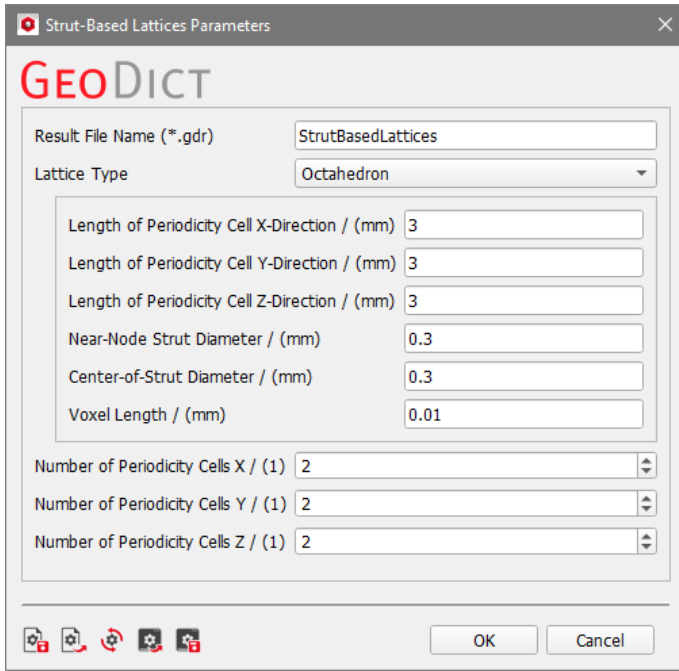

OCTETT-TRUSS

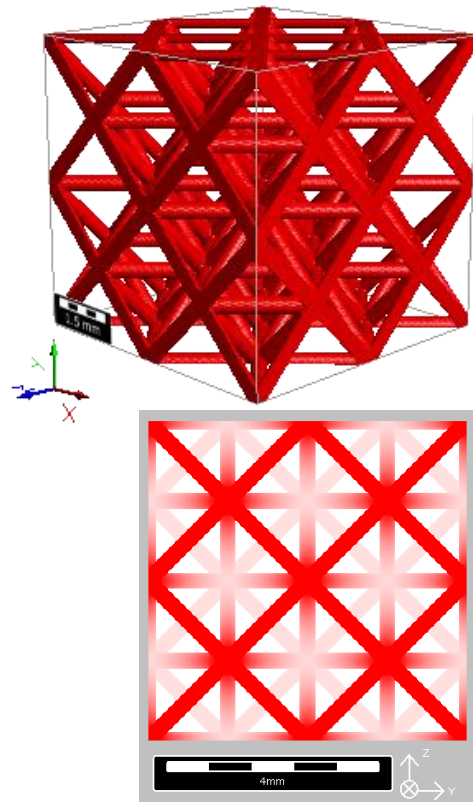
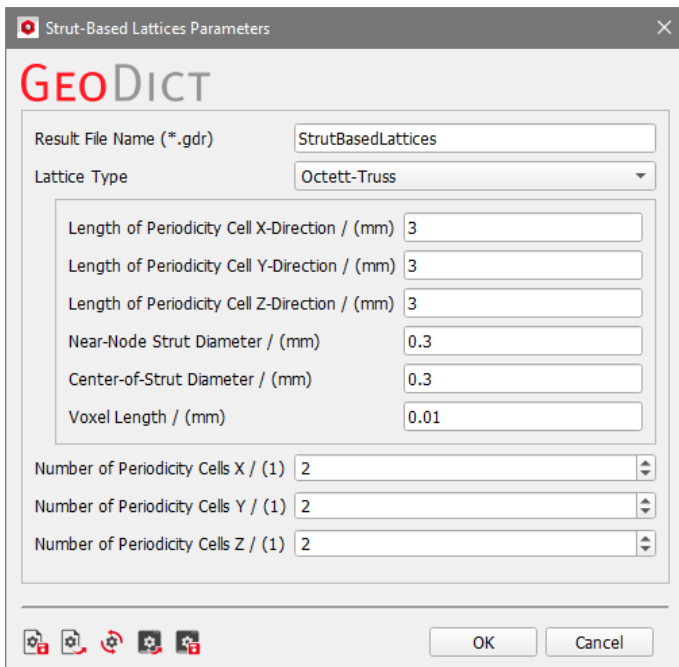

Generating lattices in 2D and in 3D

RHOMBIC-DODECAHEDRON

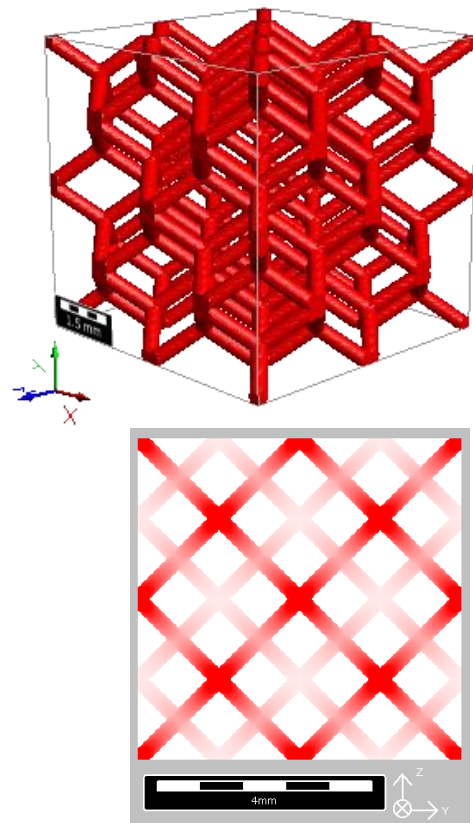
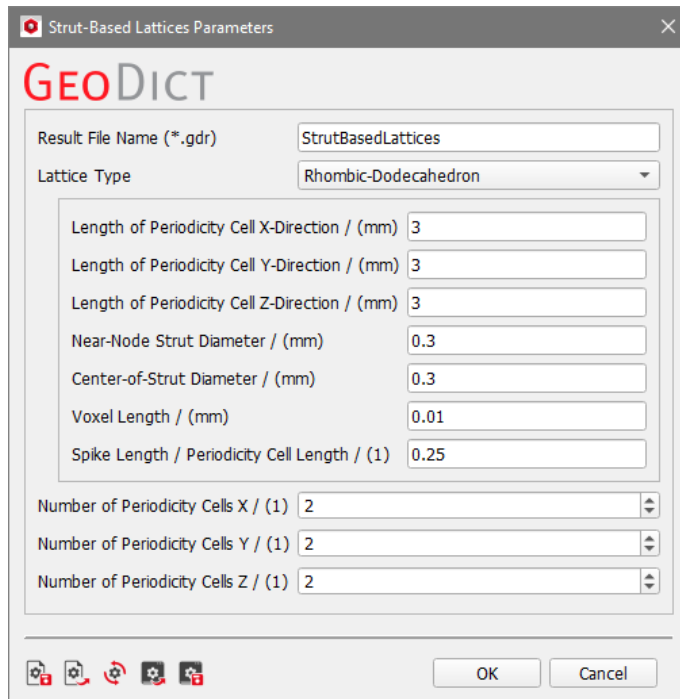

TETRAHEDRON-BASED

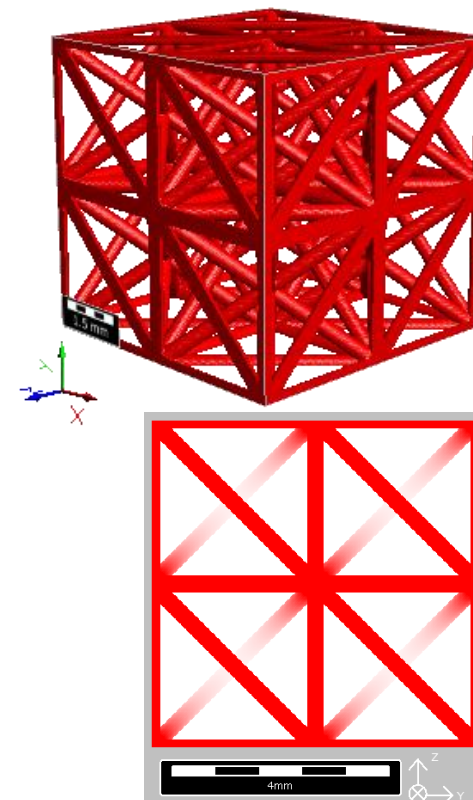
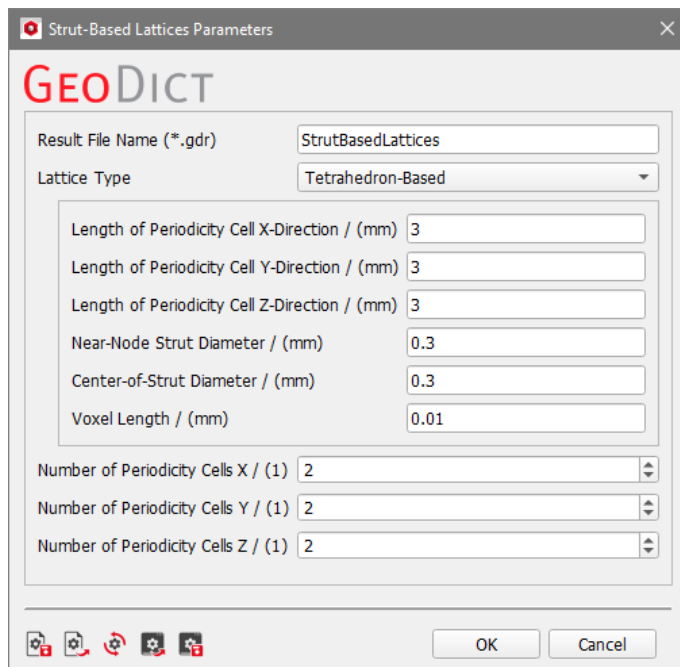

TRUNCATED-CUBE

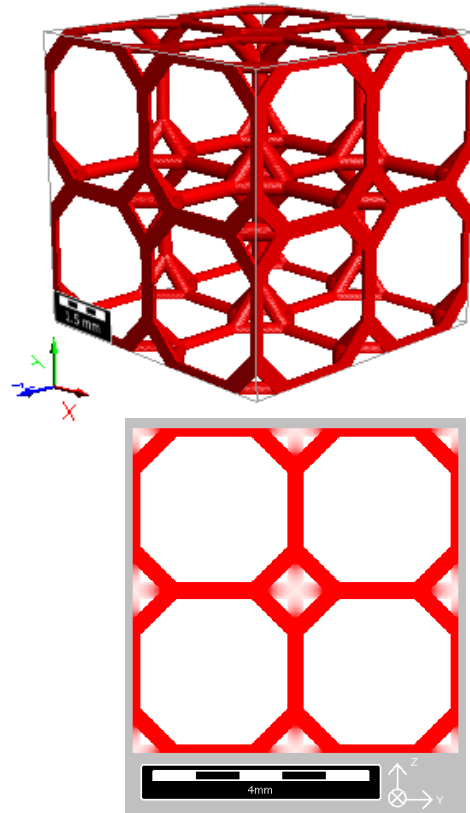
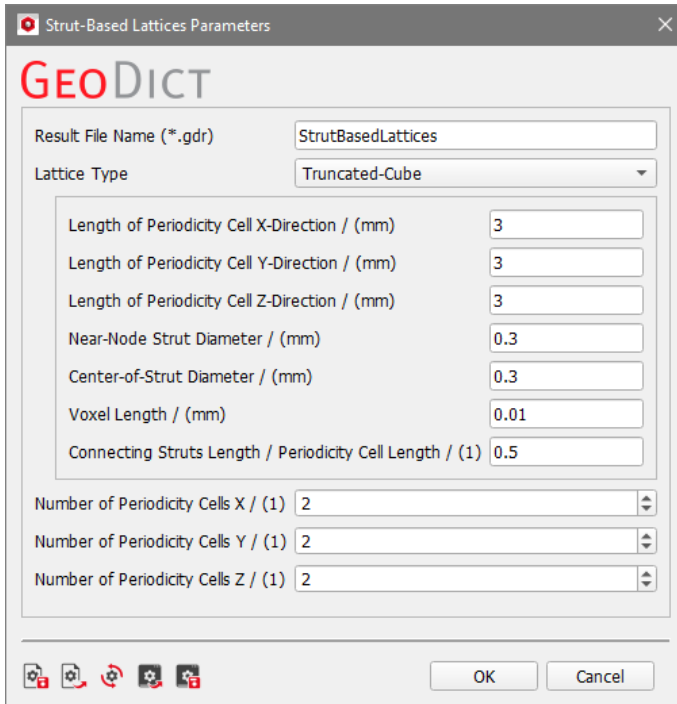

TRUNCATED-CUBOCTAHEDRON

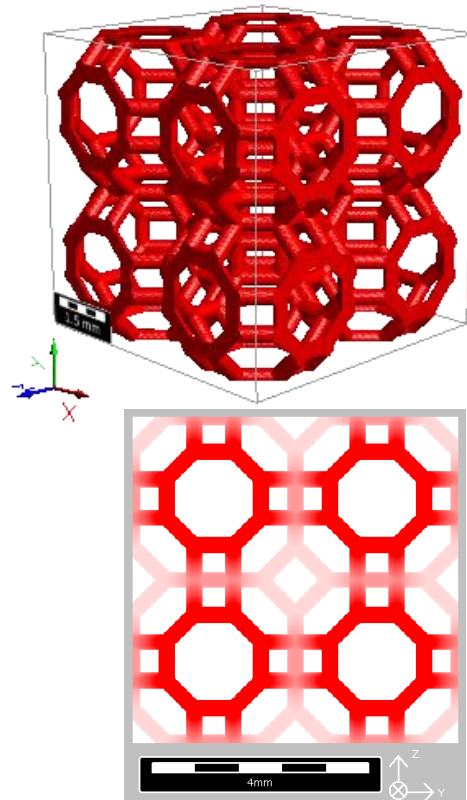
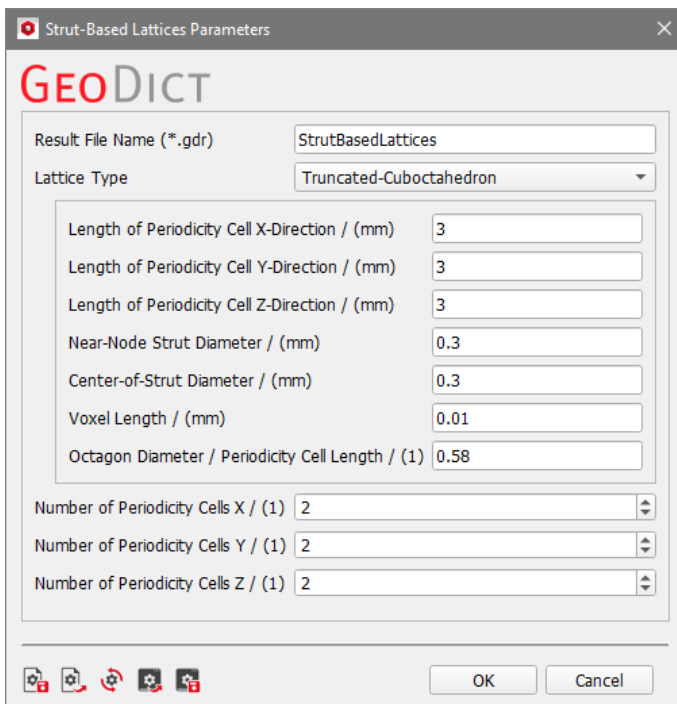

TRIPLY PERIODIC MINIMAL SURFACES (TPMS)

To generate a TPMS-based structure, a volume field is used. With the threshold mode \leq the structure is composed of all parts of the volume field that have a solid volume fraction less or equal to the given threshold. If \geq is chosen, then all parts with a higher solid volume fraction remain for the structure. The third mode $\leq \&\& \geq$ combines both of the previous mentioned threshold modes and therefore needs a lower and an upper threshold to be defined. Everything between the threshold values is kept for the structure.

The volume field on which the structure is based, may be viewed by selecting the **Volume Field** tab in the Visualization panel. Uncheck **Structure** to only display the volume field given by the solid volume fraction.

The slider in the threshold section can be used to observe the remaining structure when changing the threshold. Choose between \geq , \leq and $\leq \&\& \geq$ mode. For the $\leq \&\& \geq$ mode, only the parts with exactly this threshold value are visible.

The image displays the software's visualization settings for a TPMS structure. The main interface shows the 'Volume Field' tab selected, with 'Structure' unchecked. The 'Threshold by' dropdown is set to 'SolidVolumeFraction', and the mode is ' \geq '. The threshold value is 1.79990e-01. A slider is visible, and a red box highlights the mode dropdown and the threshold value. Below the interface are two 3D visualizations of the volume field. The left one shows a color map of the volume field with a scale from -1.50 to 1.50. The right one shows the resulting TPMS structure, which is a complex, porous lattice. Below the visualizations are two panels showing the threshold settings for different views. The left panel shows the threshold set to 1.19991e-01, and the right panel shows the threshold set to 1.08.

More information on how to choose the viewing settings can be found in the [Visualization handbook](#) of this User Guide.

CYLINDRICAL SHAPE MODE

Gyroid

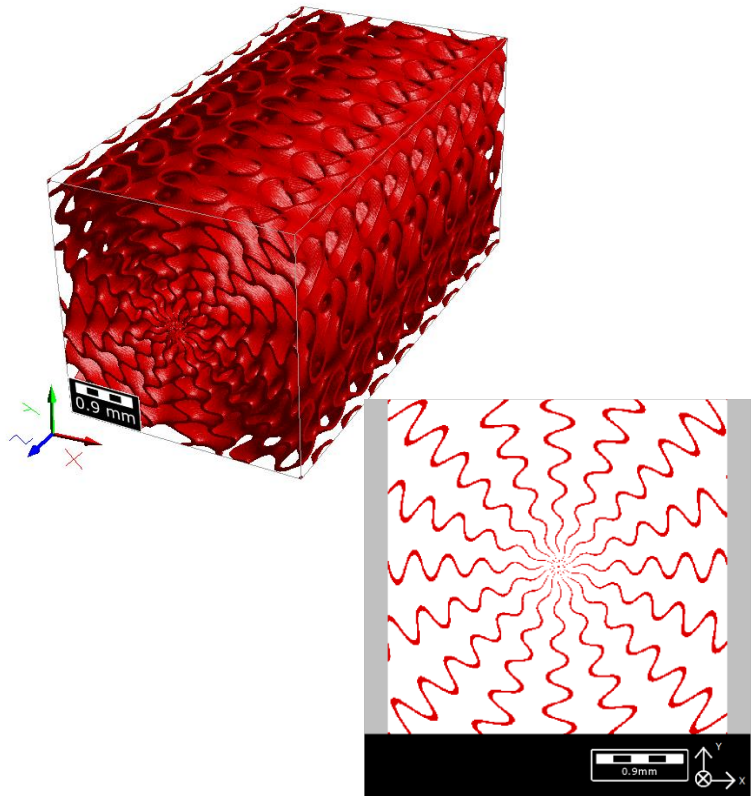
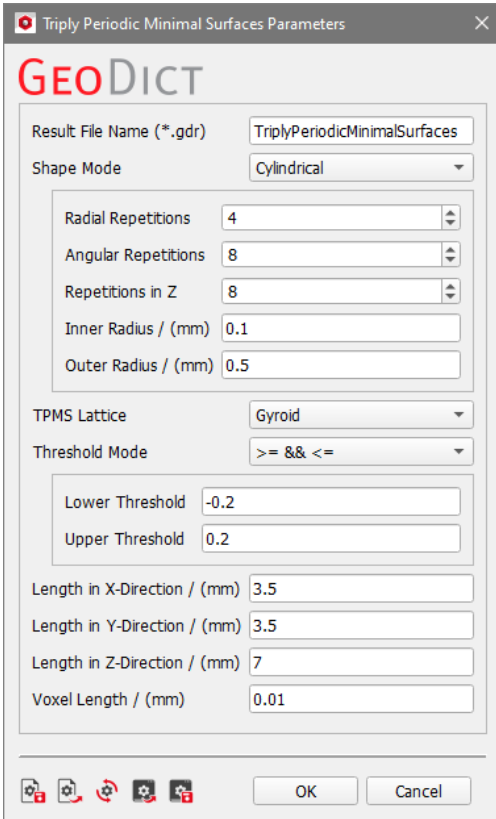

I-WP

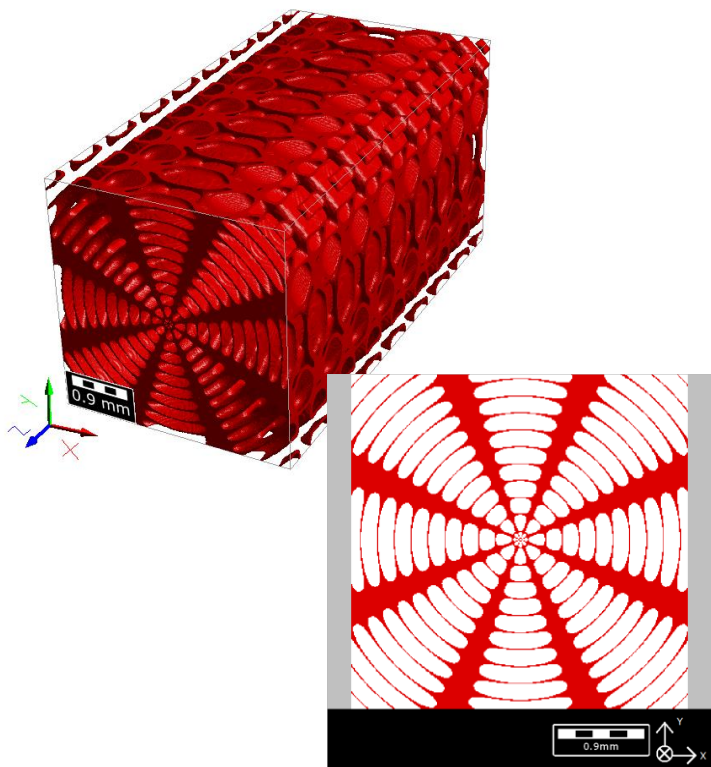
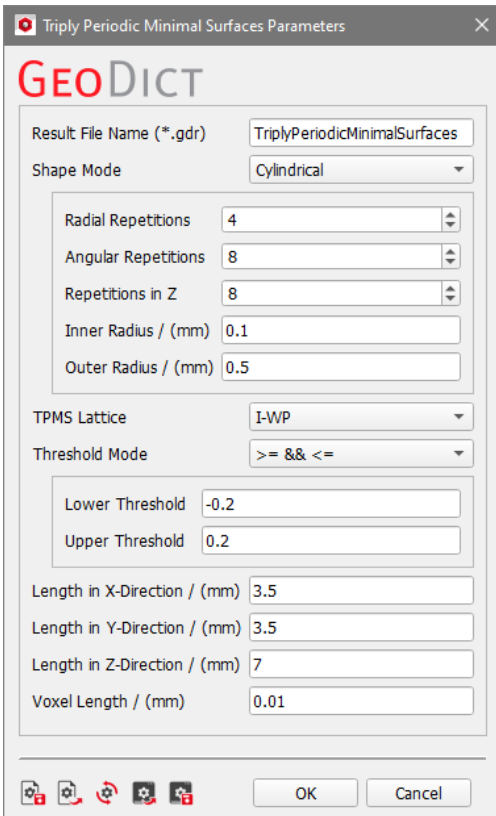

Generating lattices in 2D and in 3D

Neovius

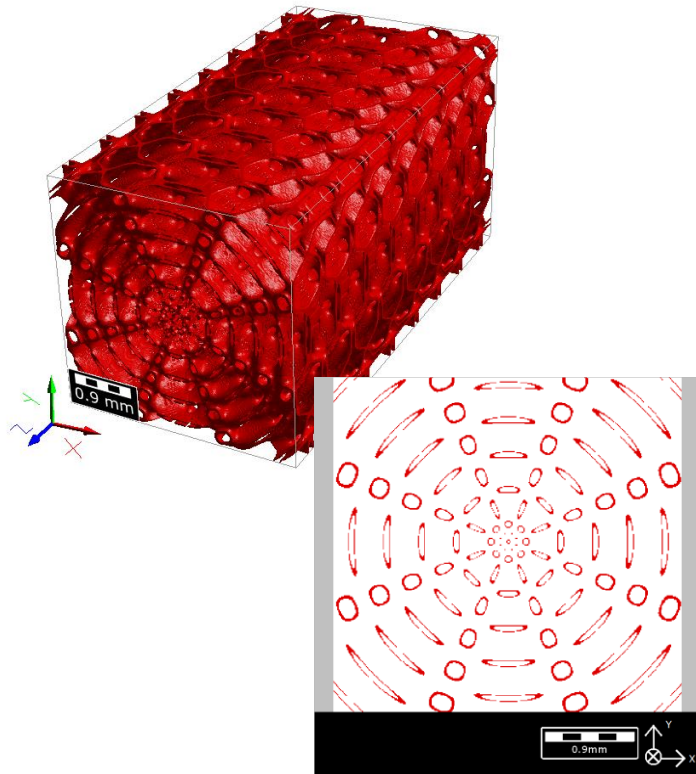
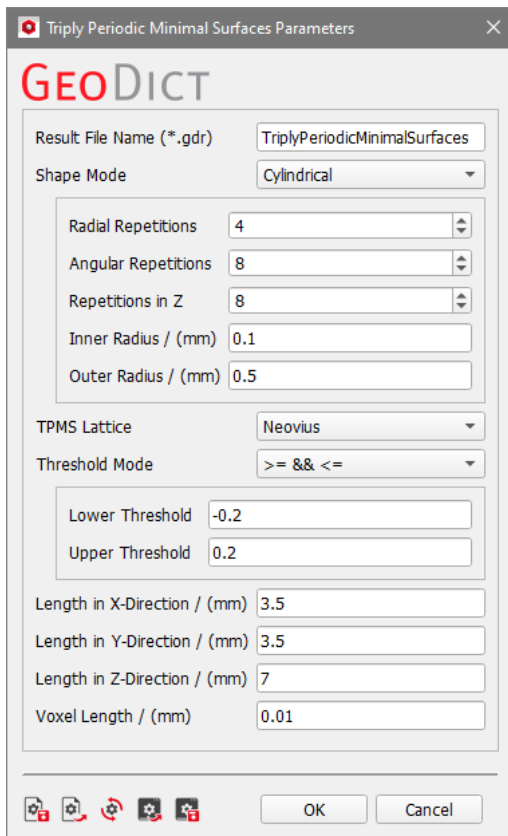

P-W

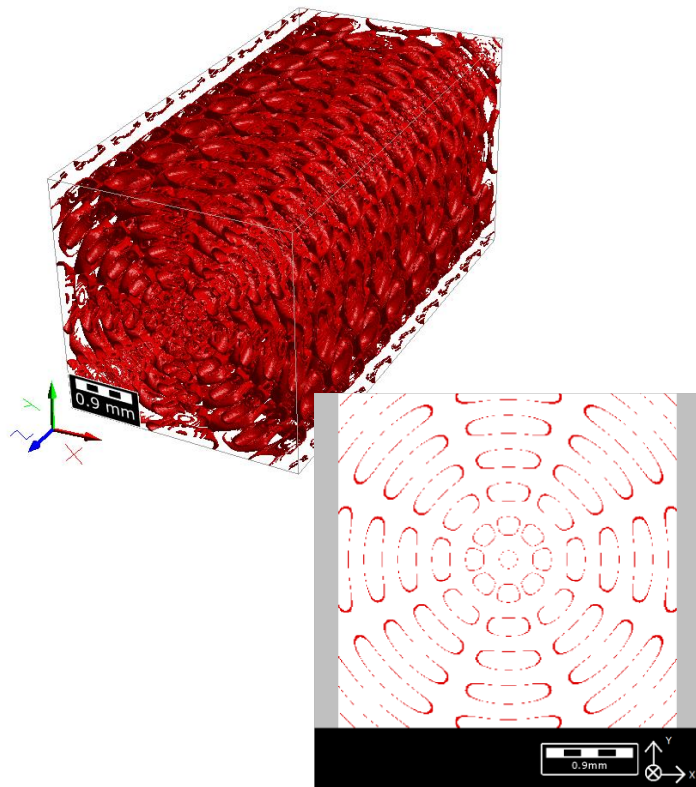
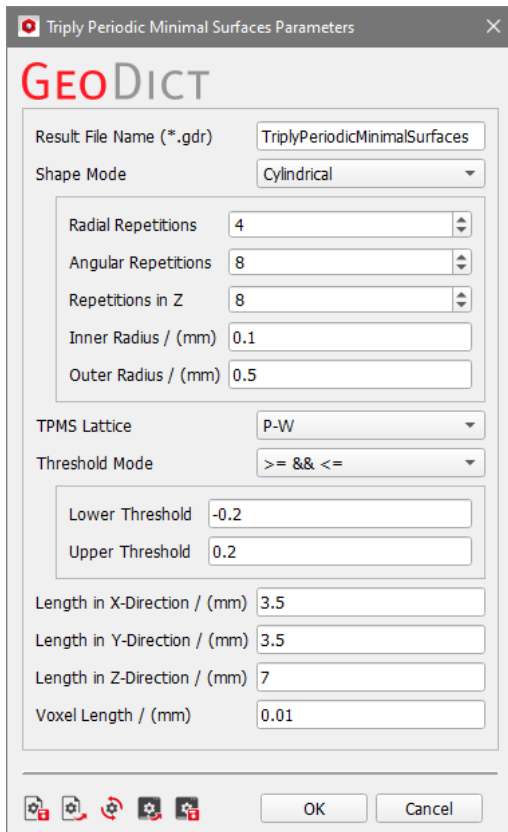

Schwarz-Diamond

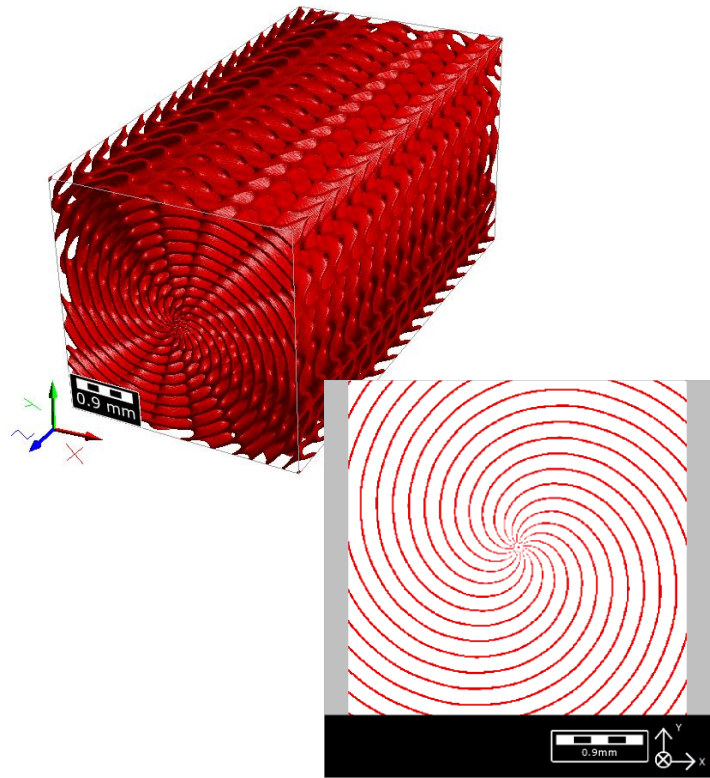
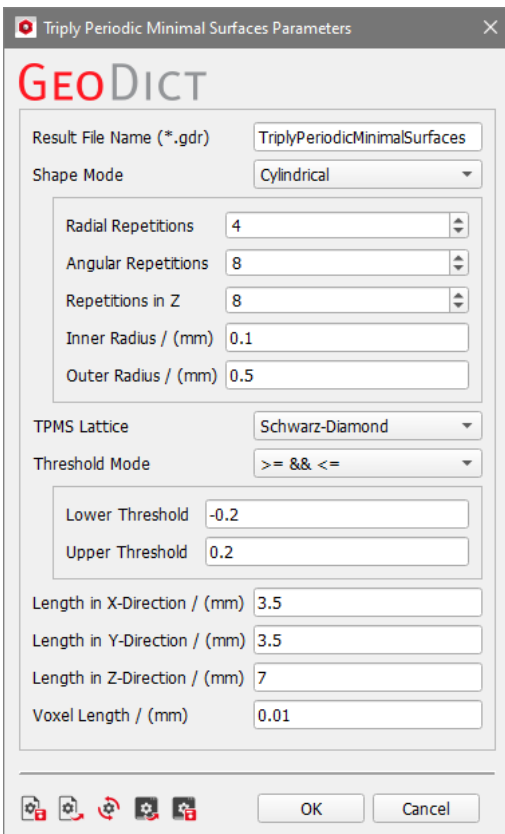

Schwarz-Primitive

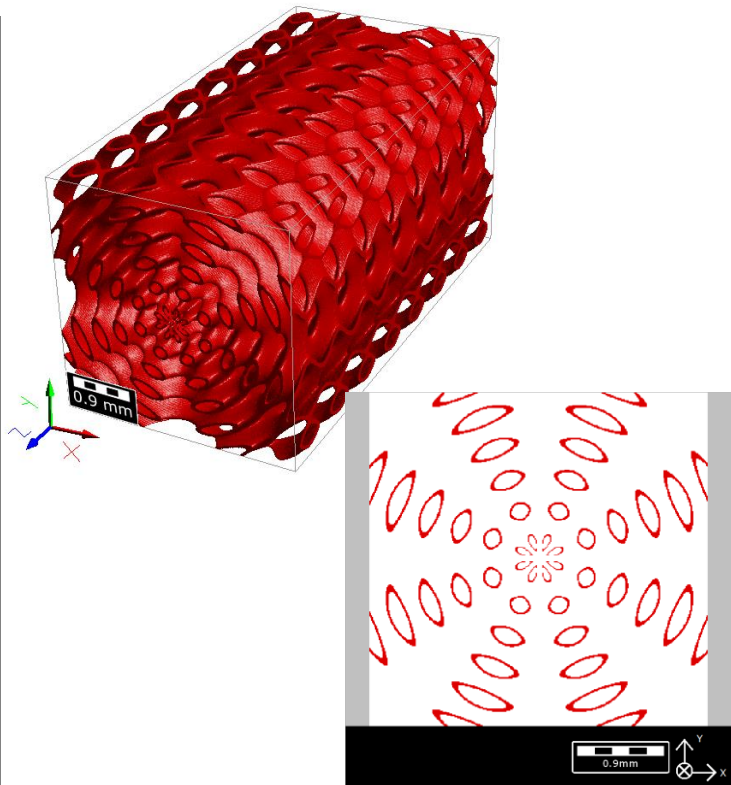
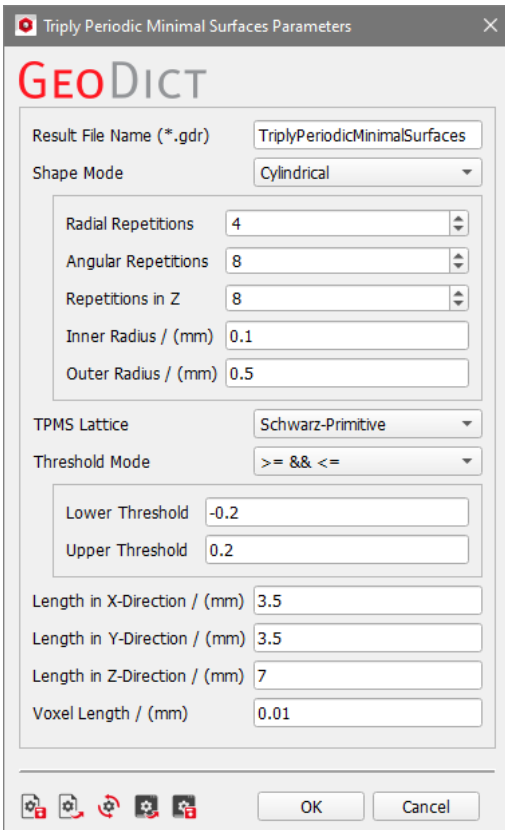

Custom

A custom function can be specified to produce a grid of triply periodic minimal surfaces.

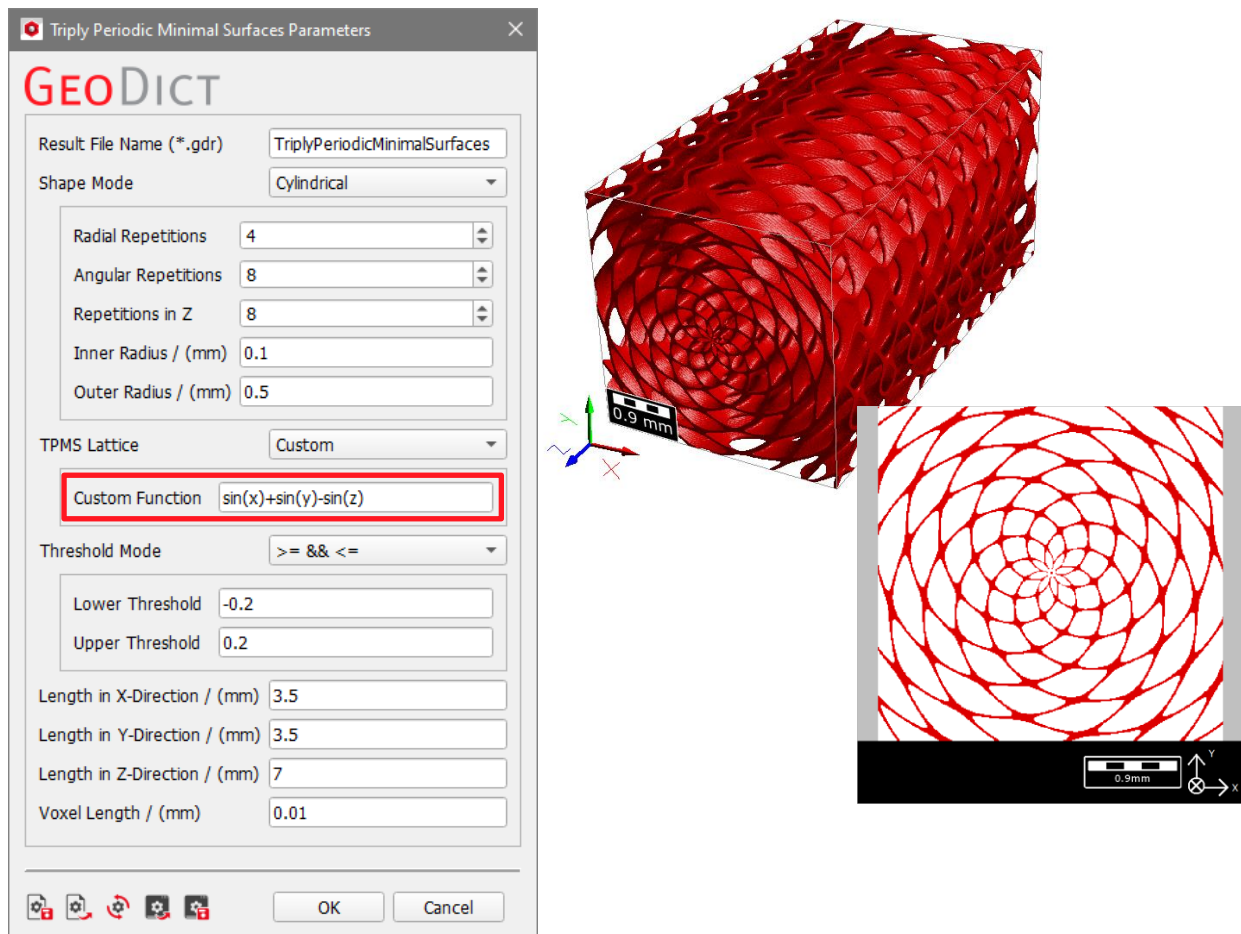

SQUARE SHAPE MODE

Gyroid

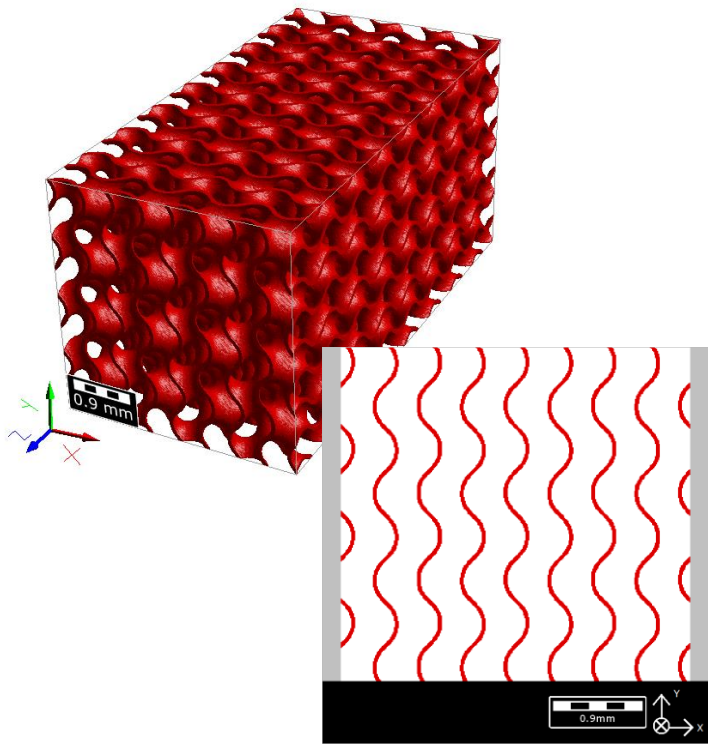
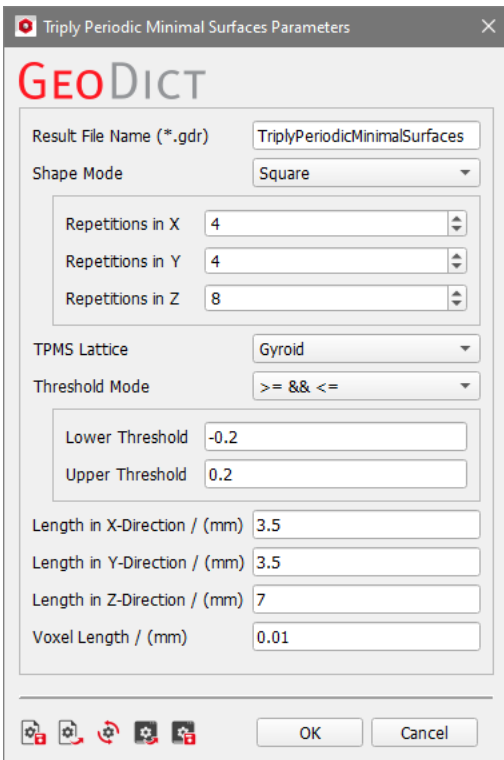

I-WP

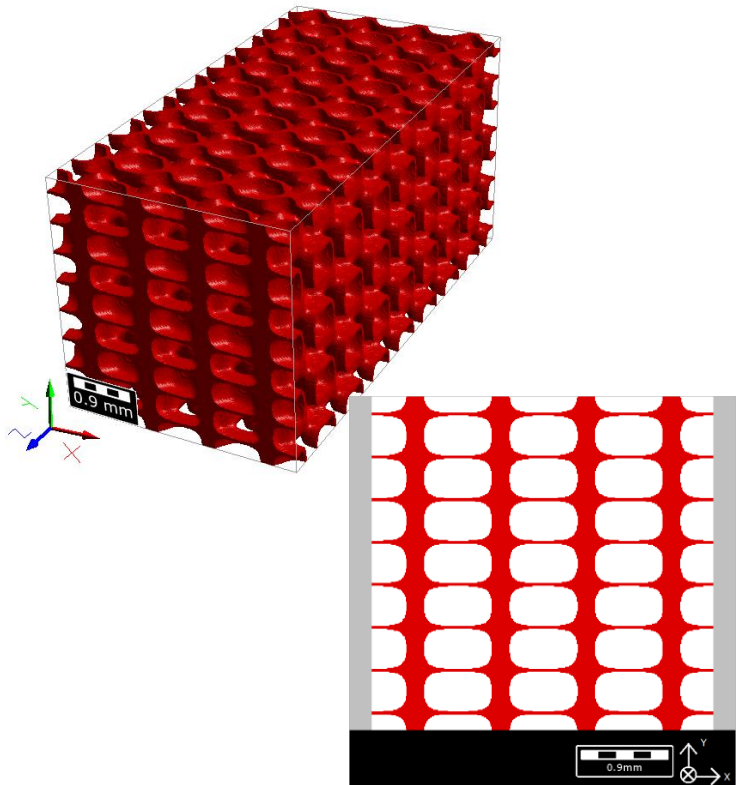
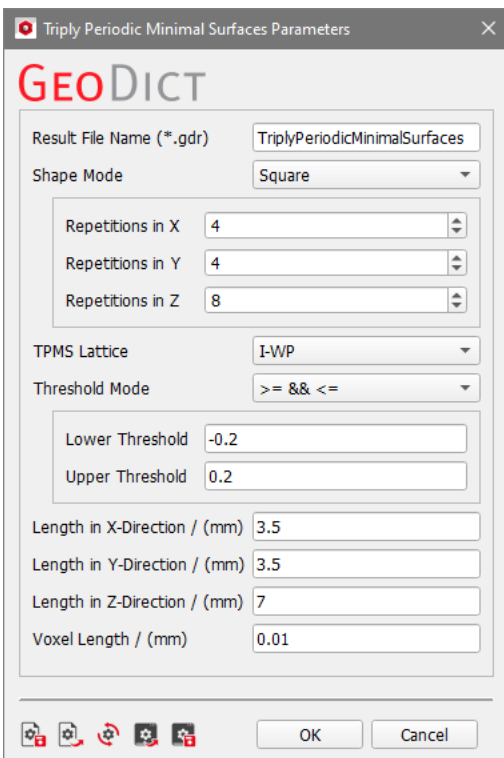

Generating lattices in 2D and in 3D

Neovius

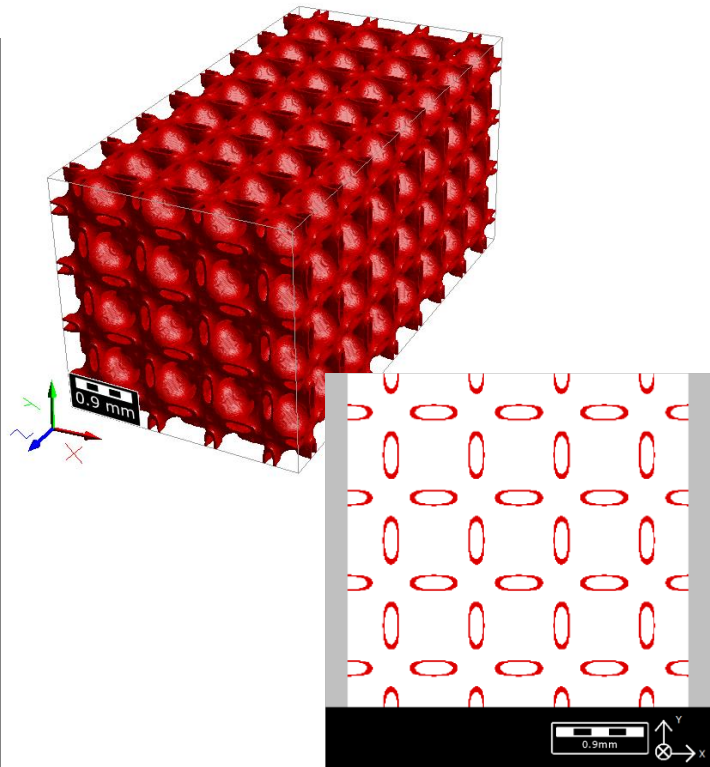
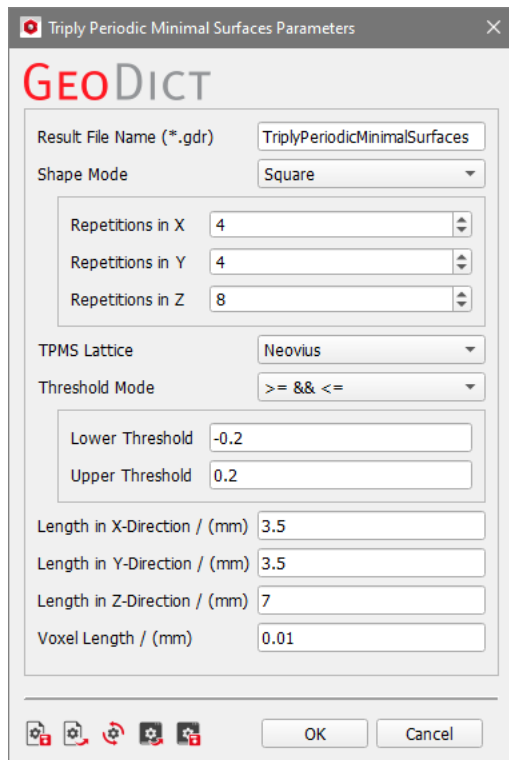

P-W

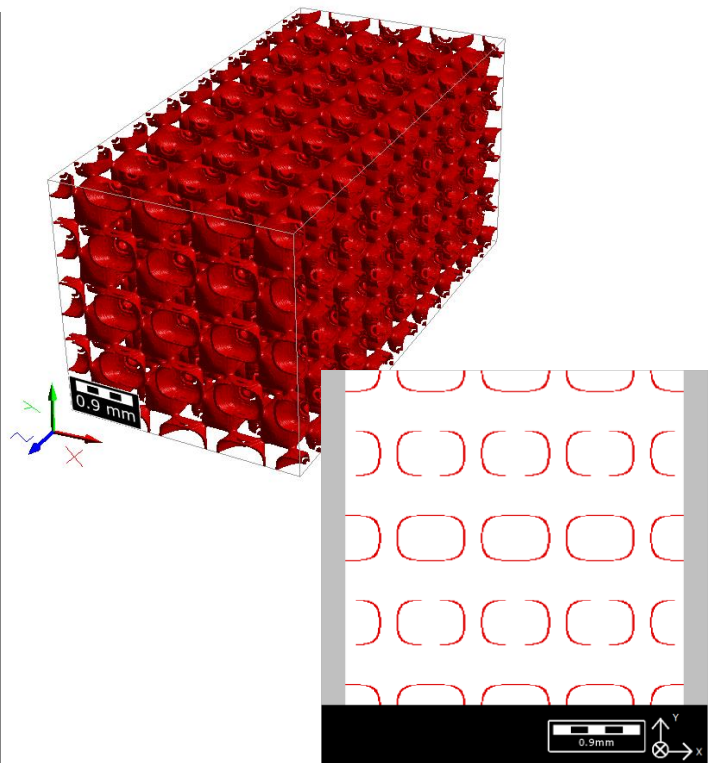
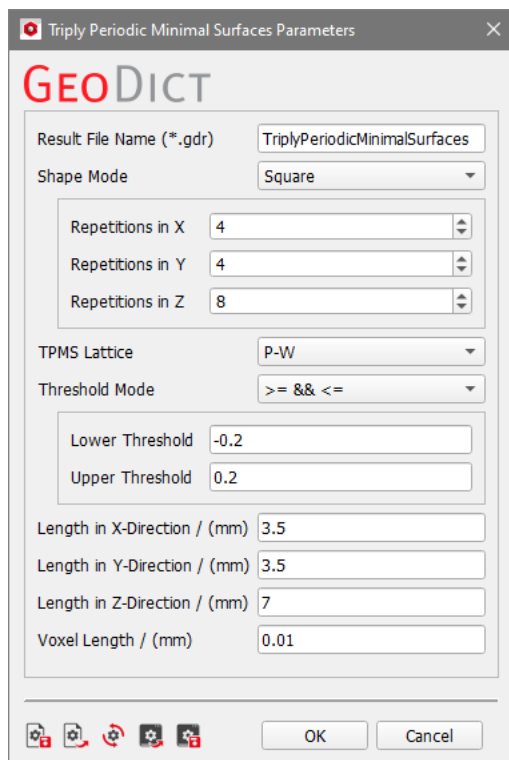

Schwarz-Diamond

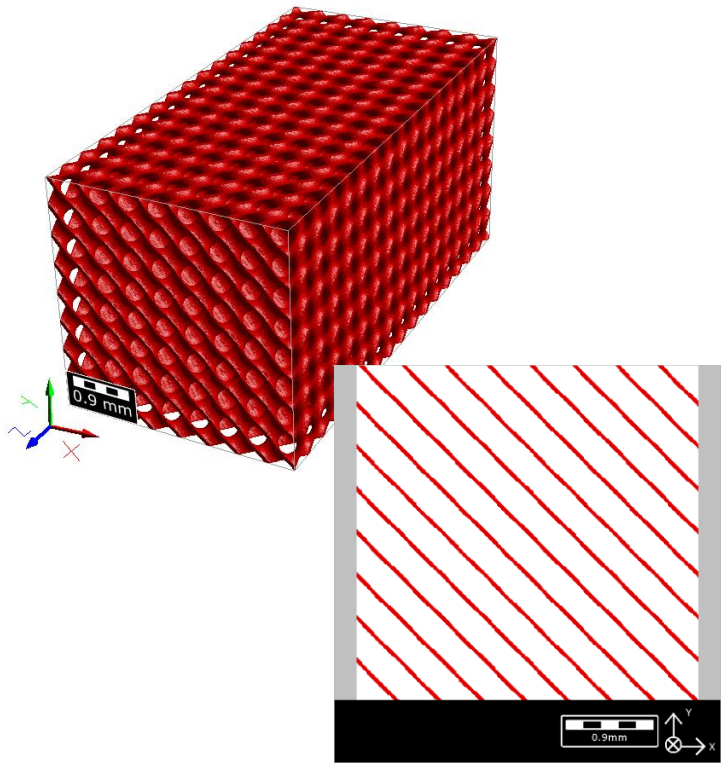
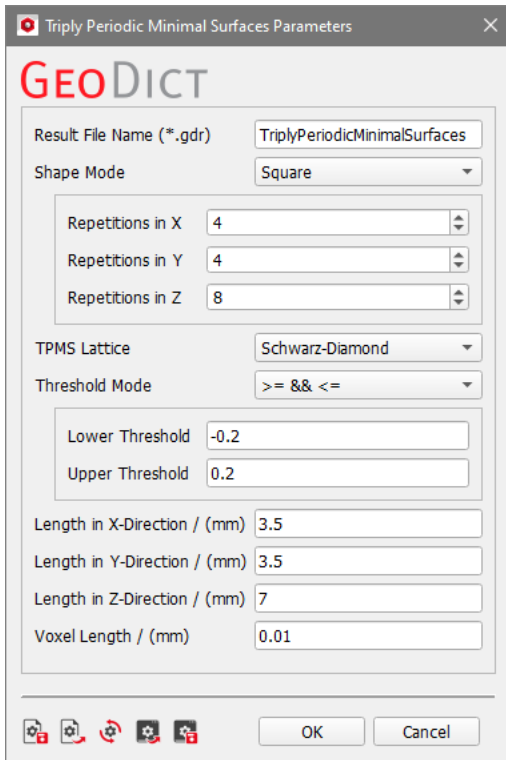

Schwarz-Primitive

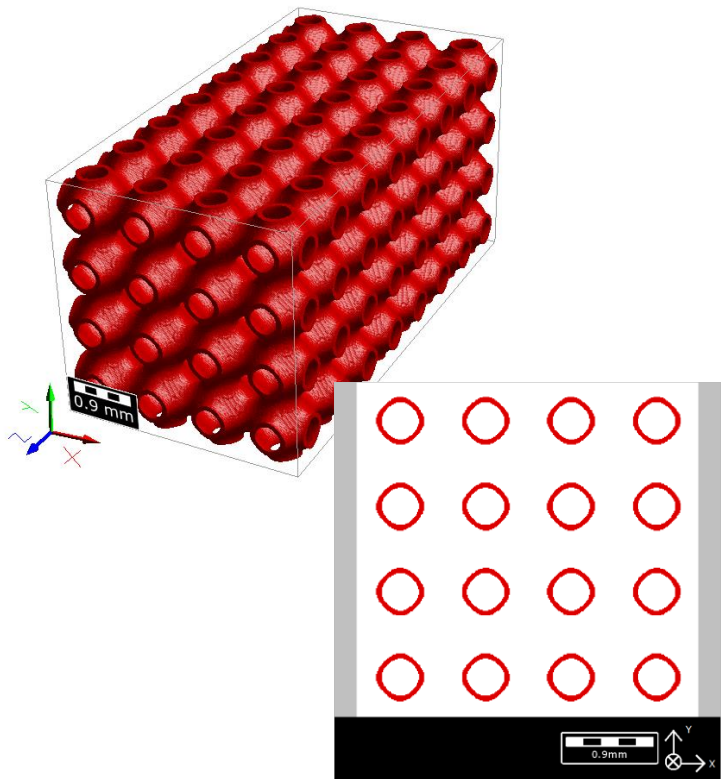
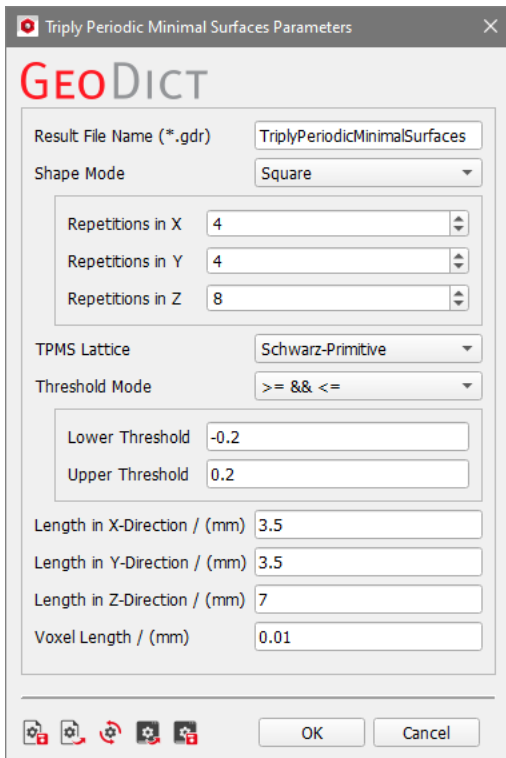

Custom

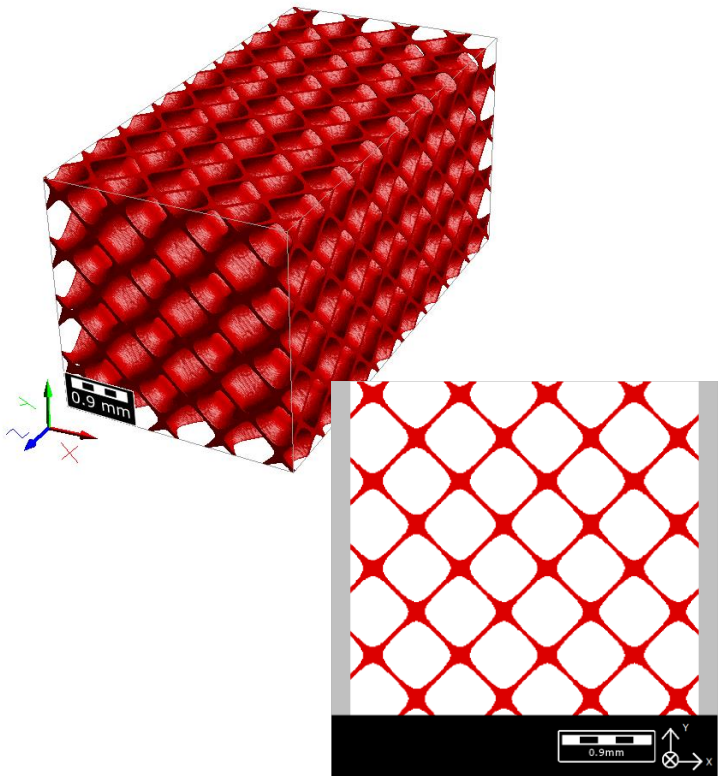
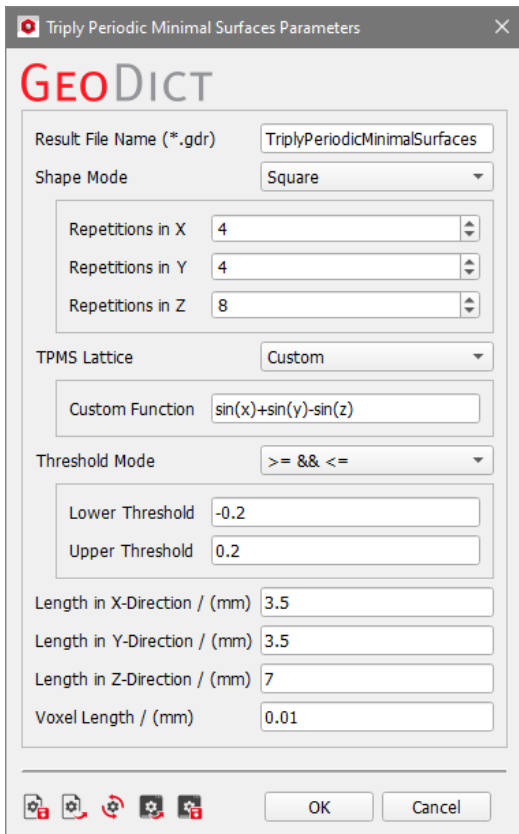

APPENDIX – RELATIONSHIP BETWEEN THE FACE-CENTERED CUBIC AND HEXAGONAL LATTICES

The Face-Centered Cubic and Hexagonal grids are strongly related: both have a packing density of $\frac{1}{3\sqrt{2}} \cdot \pi \approx 74.05\%$. In the first figure, $3 \times 3 \times 3$ Face-Centered Cubic unit cells are displayed: a) shows the usual color scheme with different colors for the corner spheres and each of the cube faces. In b), the same structure is shown, but now diagonal layers become visible. In c) only the red layers from b) are shown and the hexagonal structure becomes visible. The **Face-Centered Cubic grid consists of hexagonal layers stacked upon each other** – like the Hexagonal grid.

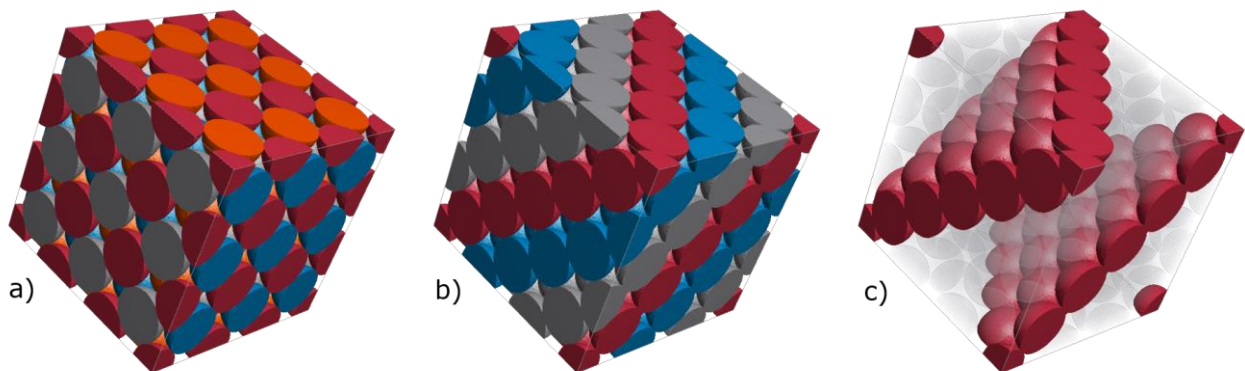

So, a Face-Centered Cubic is also a Hexagonal grid – what is the difference? It becomes apparent in the next figure.

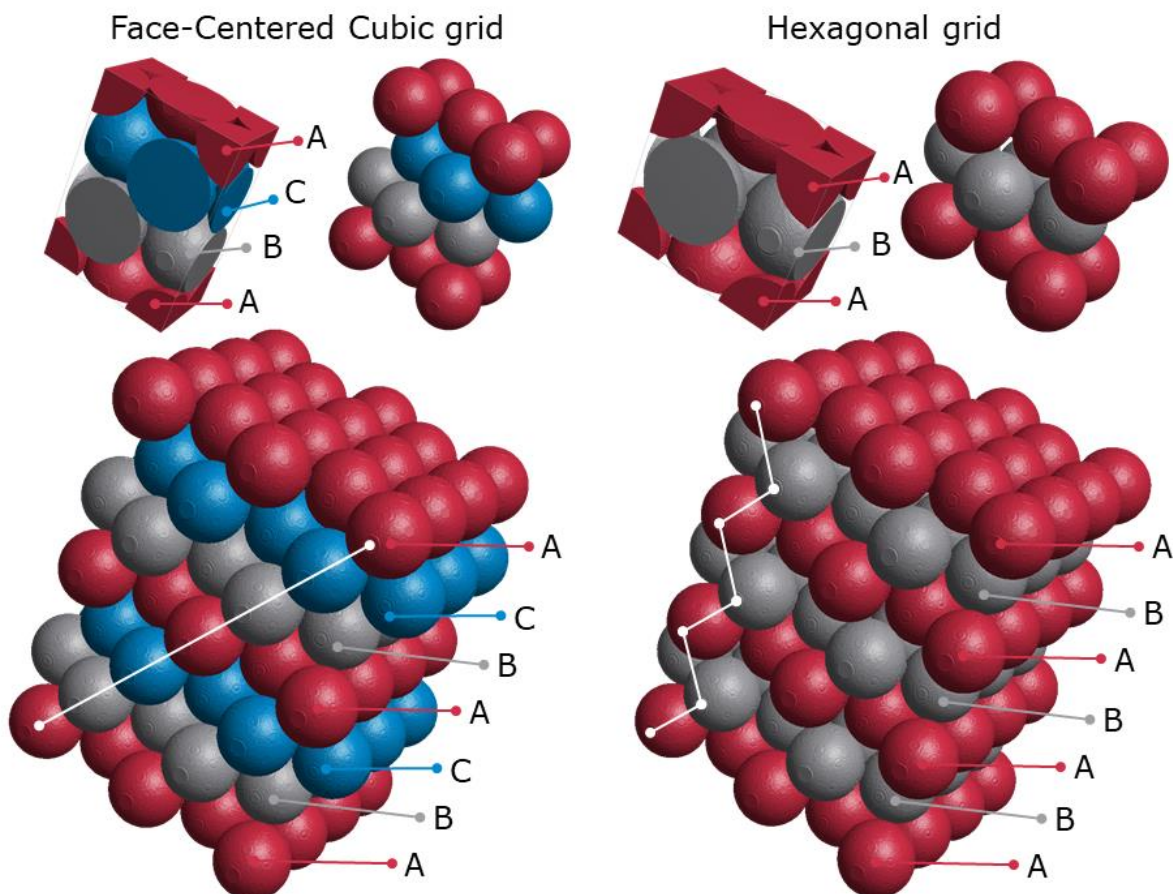

The Face-Centered Cubic grid consists of three hexagonal layers (A-B-C). The relation from layer to layer is always the same (observe the white line). The Hexagonal grid has two layers (A-B), where the stacking direction changes from layer to layer.

Technical
documentation:

Anne Blumer
Barbara Planas

MATH
2 MARKET

Math2Market GmbH

Richard-Wagner-Str. 1, 67655 Kaiserslautern, Germany
www.geodict.com